



OPERATION AND SAFETY MANUAL

Important Safety Information Inside

Read this manual before handling this firearm.

This manual is for XD-E™ FIREARMS ONLY.

Do not use this manual for XD®, XD® Mod.2®, XD-S® or XD(M)® firearms.

Keep this manual with your firearm and review it before each use. This manual is designed to fit in your shirt or jacket pocket. Do not allow others to handle or fire your firearm until they have read this manual. Transfer this manual with the firearm upon ownership change.

Download this manual on our website: www.springfieldarmory.com

Be a responsible firearm owner. Use it safely, store it securely, and always transfer a firearm responsibly and legally.

CONTENTS

Read and Understand this Manual	3	Front Fiber Optic Installation	22
Know Your Firearm	4	Field Strip	23
Safety Rules	5	Reassembly	26
Loaded Chamber Indicator	12	Magazine Disassembly	28
Trigger	13	Points Of Lubrication	29
Thumb Safety / Decock Lever	14	Parts Diagram	30
Loading/ Preparing To Fire	16	Point of Aim	34
Firing	17	Cable Lock	35
Unloading/Clearing	18	Care and Cleaning	36
Malfunction Warning	20	Disclaimer	38

NOTE: The information in this manual applies to all XD-E™ models regardless of caliber unless otherwise noted.

If you have any questions concerning information in this manual, call Springfield's Consumer Safety Department at: (309) 944-5631 for assistance.

BEFORE LOADING AND FIRING THIS FIREARM, READ AND UNDERSTAND THE INFORMATION IN THIS MANUAL.

This is an auto loading firearm. It is immediately loaded and ready to fire again after each shot until all cartridges loaded in magazine have been fired. The firearm is able to fire both with and without the magazine in place.

REMOVING THE MAGAZINE DOES NOT UNLOAD THE FIREARM NOR DOES IT ENGAGE A SAFETY. THE FIREARM IS NOT UNLOADED UNTIL THE MAGAZINE IS REMOVED AND THE CHAMBER IS EMPTY.

ABOUT YOUR OWNER'S MANUAL

This is an instruction booklet on how to operate this firearm with some basic safe handling rules. It does not attempt to provide information about using a firearm to defend yourself, how to hunt, or for competitive or target shooting. It is important to receive training from a competent firearms instructor prior to engaging in any of these activities. The National Rifle Association, your local or state authorities, or your firearm dealer may provide information regarding available instructors or training courses. If you have a license to carry concealed, never do so without prior instruction from a certified instructor. Using a firearm for self defense is a complex subject with dangers and risks for which you must be properly trained. Every safety rule has a reason behind it - read the rules carefully and understand why each is important for safety.

It is recommended that every person receive instructions from a competent firearms instructor before handling this or any other firearm.

Know and obey all firearms laws and regulations, which may vary from city to city and state to state. Do not give a firearm to someone who is not allowed to own a firearm or who may use it for a criminal purpose.

Used firearms

If you purchased this firearm as a used firearm, have it inspected and tested by a competent pistolsmith before you use it. Firearms are sometimes altered and may require repair before they can be used safely.

Store firearms safely in the home

Store firearms unloaded, locked and in a secure place. Obey firearm storage laws. Store firearms and ammunition separately. Because your children may be in other homes where firearms are stored, you should show them what to do if they see or find a firearm by showing them the Eddie Eagle video available from the NRA by calling (703) 267-1000.

OBEY ALL FIREARMS LAWS WHEN BUYING AND SELLING FIREARMS. NEVER BUY A FIREARM INTENDING TO TRANSFER IT TO SOMEONE WHO IS PROHIBITED FROM OWNING FIREARMS. NEVER EVER BE A "STRAW PURCHASER."

KNOW YOUR FIREARM XD^E

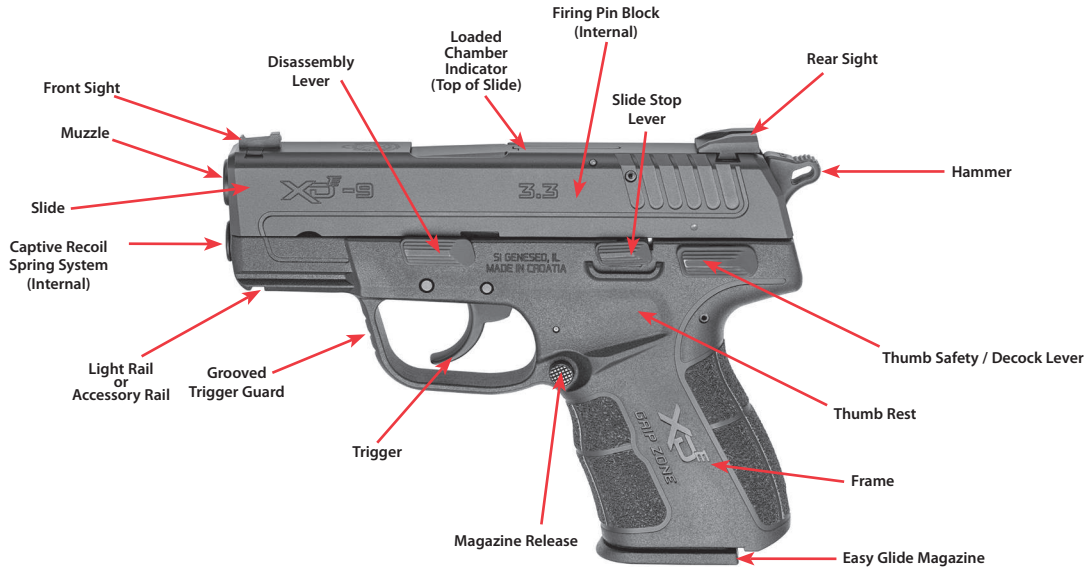

SAFETY RULES

READ AND UNDERSTAND THESE SAFETY RULES

Be A Safe Firearm Owner.

ACCIDENT (*ak' si dent*) *N.* 1. *An unintentional or unexpected happening that is undesirable or unfortunate, especially one resulting in injury, damage, harm or loss.*

Don't be the cause of an accident.

A responsible firearm owner is safety minded and always handles firearms in a safe manner by following the basic rules of safe shooting and by using common sense in the handling of a firearm.

Store firearms unloaded, locked, and in a secure place. Keep keys for locks separate from lock and in a secure place away from children. Keep firearms out of reach of children. You are responsible for children's safety.

Be A Responsible Firearm Owner.

- **Treat all firearms as if they are loaded at all times.**
- Although many safety mechanisms are designed into your firearm, firearm safety still depends on you being a responsible firearms owner.

- Never point a firearm at any person or thing you do not intend to shoot. Treat every firearm as if it is loaded.
- Be sure you have positively identified your target.
- **ALWAYS KEEP THE MUZZLE POINTED IN A SAFE DIRECTION.**
- **Do not drop your firearm.** Make sure you maintain control of your firearm at all times. **If it falls, it may fire.** If you do drop it, unload it and examine it to be sure it works correctly. Do not attempt to fire it again until you have completed this safety check.
- Never put your hand over the muzzle of the firearm.
- Keep your finger(s) off the trigger and out of the trigger guard until you are actually aiming at your target, and made the decision to fire.
- Under no circumstances should the owner of this firearm allow it to come into possession of or be handled by small children or a mentally handicapped individual.
- **DO NOT COVER THE EJECTION PORT WITH YOUR HANDS WHEN LOADING/UNLOADING YOUR FIREARM.**

BE A RESPONSIBLE FIREARM OWNER!

- Never rely on a firearm's "safety features" to protect you from unsafe firearm handling. A safety is only a mechanical device, not a substitute for common sense.
- Keep your finger off the trigger until you are on target and have made the DECISION to fire.
- Be sure of your target and backstop before you shoot. Ask yourself what your bullet will hit if it misses or goes through the target.
- Before shooting, be sure the barrel is clear of obstructions, including excessive oil and grease.
- Do not let water, snow, mud or other materials enter the barrel.
- Do not pull a firearm toward you by the muzzle.
- Always hold your firearm so you control the direction of its muzzle in case you fall or stumble.
- **ALWAYS KEEP THE MUZZLE POINTED IN A SAFE DIRECTION.**
- If anything does get into the barrel, remove cartridges, and clean bore immediately before attempting to shoot. Obstructed barrels can burst and injure you and/or bystanders.
- Maintain possession of your firearm at all times when you are on the firing range or during target practice. **DO NOT ALLOW OTHERS TO HANDLE YOUR FIREARM UNLESS THAT PERSON IS BEING INSTRUCTED OR TRAINED.**
- **DO NOT COVER THE EJECTION PORT WITH YOUR HANDS WHEN LOADING/UNLOADING YOUR FIREARM.**



The **XD^F** pistol, like all firearms, is a dangerous weapon if not handled properly.

BE A SAFE FIREARM OWNER!

- **ALWAYS KEEP THE MUZZLE POINTED IN A SAFE DIRECTION.**
- Firearms and alcohol or drugs do not mix. Do not take them before or during shooting activities. Your vision, coordination and judgment could be impaired, making firearm handling unsafe.
- When taking medication, seek a doctor's advice to be sure you can operate and handle your firearm safely.
- Receive training from a competent firearms instructor before using any firearm.
- Before attempting to shoot, practice operations by using snap caps (dummy rounds). Become familiar with the safety features, trigger control, and handling of the firearm.
- Make sure you maintain control of your firearm at all times.
- **Always keep and carry your firearm with an empty chamber until you intend to shoot, so your firearm cannot be fired unintentionally.**
- Firearms should be unloaded when not in use. This means both the chamber and magazine are empty.
- When transferring a firearm by hand, always open the action and check to assure that it is unloaded prior to handing it over to someone.
- Never take anyone's word that a firearm is unloaded. When receiving a firearm, always open the action and check that it is unloaded.

BE A SAFE FIREARM OWNER!

- **Do not try to change your firearm's trigger pull, because alterations of trigger pull usually affect sear engagement and might cause accidental firing.**
- Never use a firearm that jams or fails to function properly. Should this occur, return to Springfield, Inc. for warranty/repair.
- If your shot sounds weak or underpowered, it could mean a bullet is in the chamber/bore. The firearm should be immediately unloaded and the chamber/bore checked for obstructions before re-firing.
- **DO NOT "HORSEPLAY"** with a firearm. Your firearm cannot think ...but you can. Firearm safety depends on you.

IMPORTANT WARNING

There is no safe way to discharge a firearm in a home or apartment. Bullets will go through walls, floors, furniture, and appliances and still cause serious injury or death to persons in the house, next door, or outside. Accidental discharges indoors ALWAYS result in property damage or personal injury.



WARNING: When you squeeze the trigger, you must expect the firearm to fire. You must take full responsibility for firing it. Your care can avoid accidental discharge and thereby avoid accidental injury and death.

READ THESE RULES!

- Load firearm only when on range preparing to fire. Unload it before leaving range.
- **Treat every firearm as if it is loaded ... all the time!**
- Load and unload with the firearm muzzle pointed in a safe direction.
- Be certain firearm is unloaded before cleaning.
- Completely unload your firearm before storing, travelling, standing it against an object, laying it down, entering a house, car, truck, boat, RV/camper, building, or handing it to someone.
- **Never leave a loaded firearm unattended.**
- Tragedy may result if a child finds your firearm and plays with it. Keep every firearm secure. Children do not believe firearms can kill.
- Store firearms and ammunition separately. Both should be placed beyond children's reach.
- Obey all laws regarding the storage and security of firearms in the home.
- Know and obey the laws regarding the transportation and carrying of firearms.
- **Never carry any firearm, loaded or unloaded, in your pocket, purse or tucked in your belt or waistband. Use a firearm case or a proper holster.**
- **Old or reloaded ammunition may cause damage to the firearm and/or injure you or others. Use only clean, dry, original, high-quality, commercially manufactured ammunition. Using reloaded ammunition may void the warranty.**
- **ALWAYS REMEMBER, REMOVING THE MAGAZINE DOES NOT UNLOAD THE PISTOL NOR DOES IT ENGAGE A SAFETY.**
- **ALWAYS REMEMBER, THE PISTOL IS NOT UNLOADED UNTIL THE MAGAZINE IS REMOVED AND THE CHAMBER IS EMPTY.**
- **ALWAYS REMEMBER, THIS FIREARM IS ABLE TO FIRE WITH OR WITHOUT THE MAGAZINE IN PLACE.**
- **DO NOT COVER THE EJECTION PORT WITH YOUR HANDS WHEN LOADING/UNLOADING YOUR FIREARM.**

TREAT EVERY FIREARM AS IF IT IS LOADED ... ALL THE TIME!

- Many ammunition identifications sound similar. Make sure you use the right caliber/size ammunition in your firearm.
- If firearm fails to fire when the trigger is pulled, keep it pointed at the target for at least 30 seconds. Remove the magazine before opening the action. Remove the cartridge from the chamber. Sometimes slow primer ignition will cause a “hang fire” and the cartridge will go off after a short pause.
- When group firing, always appoint someone to maintain safety control. Obey his/her commands immediately and completely.
- While shooter is loading, firing, and unloading, spectators need to remain behind the shooter.
- **Always wear protective glasses when shooting.**
- **Always wear hearing protection when shooting.**
- Never shoot at hard flat surfaces or water; bullets will ricochet unpredictably.
- **Do not alter or modify your firearm.**
- Have your firearm serviced regularly by a qualified pistolsmith.
- Discharging firearms in poorly ventilated areas, cleaning firearms, or handling ammunition may result in exposure to lead and other substances known to cause birth defects, reproductive harm, cancer and other serious physical injury. Have adequate ventilation at all times. Wash hands thoroughly after firing your firearm, after cleaning your firearm, or whenever you have handled ammunition.
- Always use quality ammunition.
- **ALWAYS KEEP THE MUZZLE POINTED IN A SAFE DIRECTION.**
- **DO NOT COVER THE EJECTION PORT WITH YOUR HANDS WHEN LOADING/UNLOADING YOUR FIREARM.**



Safety and instruction manuals are available from Springfield, Inc and at springfield-armory.com/resources.



Always wear eye and ear protection when using any firearm.

HANDLING

We want you to be a safe, satisfied firearm owner.

Before attempting to load this firearm with live ammunition, follow the sequence of operations shown here without ammunition or with snap caps.

By practicing operations with snap caps, you will become familiar with:

- Safety features,
- Trigger control (snap caps),
- Handling of your firearm.

As a result, you will be a safer, more confident user when aiming at your first target.

NOTE: Extensive dry firing can accelerate component wear/stress. Use snap caps if dry firing on a regular basis.



WARNING: When you squeeze the trigger, you must expect the firearm to fire. You must take full responsibility for firing it. Your care can avoid accidental discharge and thereby avoid accidental injury and death.

Write or call us concerning any items you do not understand and/or which might relate to your safety and the safe operations of any of our products.

Springfield, Inc.
Consumer Safety Department
420 West Main Street
Geneseo, IL 61254
(309) 944-5631
1-800-680-6866



Safety and instruction manuals are available from Springfield, Inc and at springfield-armory.com/resources.

LOADED CHAMBER INDICATOR

Your **XD^F** firearm has a loaded chamber indicator (See Figure 12-1). The indicator allows you to observe whether a cartridge is in the chamber. When a cartridge is in the chamber the indicator raises above the barrel (See Figure 12-2).

When the loaded chamber indicator is up, the firearm is loaded and is ready to fire.

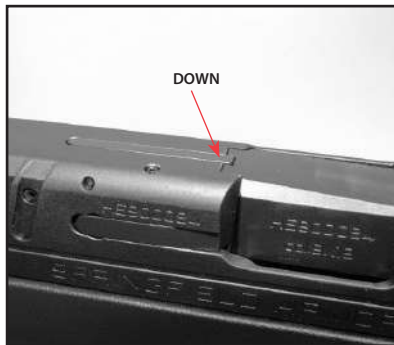

Figure 12-1

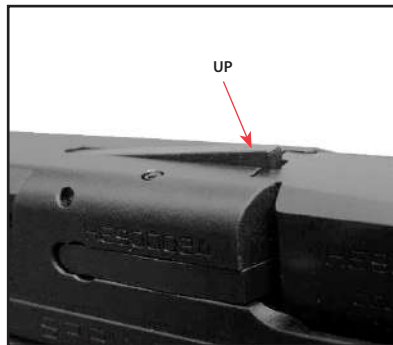

Figure 12-2



WARNING! *Even though the chamber is empty there may be cartridges in the magazine. The firearm is not completely unloaded until the magazine is removed and the chamber is empty.*



Never trust a safety. Always assume the firearm is loaded.

TRIGGER - DOUBLE ACTION / SINGLE ACTION

WARNING: This is a “Double Action” firearm. THE PISTOL CAN FIRE if the hammer is down and trigger is depressed.

The XD-E™ Pistol is designed with a “Double Action” trigger mechanism. This means the trigger system works in either of two modes. Double action or single action.

In “Double Action” mode the pistol will fire when loaded, hammer is down, safety lever is moved to the firing position and the trigger is depressed. Doing so will simultaneously cock and release the hammer to fire once the trigger reaches its rearward limit.

The remaining rounds will be fired in single action mode until all rounds are fired or the hammer is lowered (decocked).

In “Single Action” mode the pistol will fire when loaded, hammer is cocked and the trigger is depressed. Single action firing occurs after the slide is manipulated to load a round in the chamber and for each consecutive shot fired.

If the pistol is decocked (hammer down position) the pistol must be fired using the double action mode, which will occur automatically when the trigger is depressed. Pressing the thumb safety / decock lever (See page 14) downward past the horizontal position will decock or lower the hammer, requiring the pistol to be fired in the double action mode.



Figure 13-1

WARNING: Always keep firearm pointed in safe direction. Keep finger off trigger until ready to fire.

THUMB SAFETY / DECOCK LEVER

WARNING: When decocking the pistol never touch the trigger, as doing so could unintentionally discharge the pistol causing property damage, injury or death.

The XD-E™ is equipped with ambidextrous thumb safety/decock lever that act as both a manual safety and a hammer decocker. The levers operate in three positions:

1. When the lever is pressed upward (Figure 14-1), the manual safety is engaged and the pistol will not fire if the trigger is depressed.
2. When the lever is horizontal (Figure 14-2), the pistol is in the firing mode and will fire if the trigger is depressed.
3. When the hammer is cocked and the lever is pressed downward past the horizontal position (Figure 14-3) the hammer will rapidly fall to the lowered position and rest on the safety sear without firing. From this condition the pistol can be fired in the double action mode (See page 13).

NOTE: The rapid fall of the hammer is a normal function when the decock lever is pressed downward.

NOTE: The XD-E™ pistol can be put in the “SAFE” position when the hammer is cocked (Figure 14-1) or decocked.

WARNING: Always keep firearm pointed in safe direction. Keep finger off trigger until ready to fire.



Figure 14-1



Figure 14-2



Figure 14-3



Figure 14-2

THUMB SAFETY / DECOCK LEVER

WARNING: When decocking the pistol never touch the trigger, as doing so could unintentionally discharge the pistol causing property damage, injury or death.

NOTE: The XD-E® pistol can be put in the "SAFE" position when the hammer is cocked (Figure 15-1) or decocked (Figure 15-2).

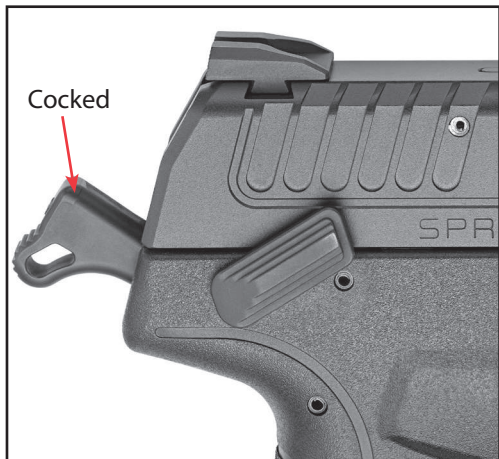

Figure 15-1

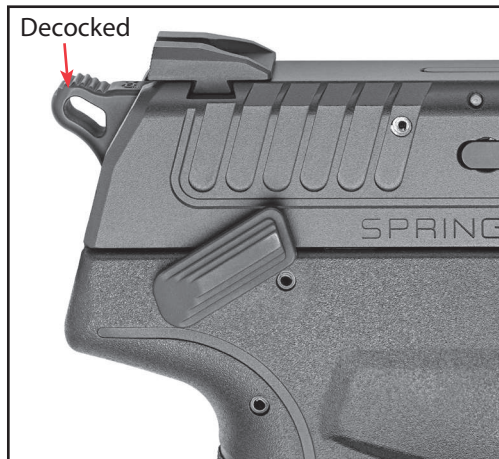

Figure 15-2

LOADING/PREPARING TO FIRE

1. Place the **EMPTY** magazine in the magazine well, located in bottom of firearm grip. Make sure the magazine is **EMPTY** or you will inadvertently load the firearm. Push firmly enough on bottom of magazine to make sure it is properly seated. A distinctive “click” will confirm the magazine has been properly inserted. Pull the slide completely to the rear until it locks back.
2. Depress magazine release and remove magazine.
3. Ensure that you are using the proper caliber ammunition for your firearm. Place rim of first cartridge on front of follower (See Figure 16) then push the cartridge down on the follower and slide the cartridge under the lips of the magazine completely to the rear. Load successive rounds by pushing cartridge down on previously loaded cartridge. Use only clean, dry, original, high-quality, commercially manufactured ammunition. Using reloaded ammunition may void warranty.
4. **POINT FIREARM IN A SAFE DIRECTION AND KEEP FINGER OFF TRIGGER.** Re-insert **LOADED** magazine into magazine well, located in bottom of firearm grip. Push firmly enough on bottom of magazine to make sure it is properly seated.

WARNING Never touch the trigger when loading or unloading the firearm.



Caution: Do not slam or forcefully jam magazine into magazine well.

5. Depress the slide stop lever to allow slide to move forward and load a cartridge from the magazine into the chamber.
6. The loaded chamber indicator will be in the up position (See Figure 12-2).
7. Move thumb safety/decock lever to safe position (See page 14).
NOTE: Thumb safety/decock lever can be moved to safe position when the hammer is cocked or depress lever to decock.



Caution: Never load cartridge by hand directly into the chamber.



Caution: The firearm is now ready to fire.

NOTE: An alternative method to load the cartridge into the chamber is to forcefully pull the slide completely to the rear and in one motion quickly release it, allowing the slide to slam forward unimpeded under its own force. (Do not hold the slide as it moves forward. “Riding the slide” in this manner can cause cartridge to jam or misfeed.) The loaded chamber indicator will be in the up position (See Figure 12-2).



Caution: Do not cover the ejection port with your hand when loading unloading your firearm.

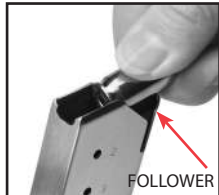

Figure 16

FIRING

If you have never fired a firearm before, follow the sequence of operations shown here without ammunition or with snap caps. Then load only **one** cartridge into the magazine for your first live ammunition firing.

1. **POINT FIREARM IN A SAFE DIRECTION WHILE KEEPING YOUR FINGER OFF OF THE TRIGGER.**
2. Move thumb safety/decock lever to safe position (See page 14). Load cartridge into chamber from magazine following the procedure described on page 16.



CAUTION: THE FIREARM IS NOW READY TO FIRE. BE PREPARED FOR NOISE AND RECOIL WHEN FIREARM FIRES.

4. Aim firearm at target by aligning sights (See Figure 34-1). Depress safety to the fire position.
5. Now lightly place finger on trigger, and slowly squeeze trigger to fire the firearm. Spent cartridge is expelled up and to the right.



Always wear eye and ear protection when using any firearm.



Safety and instruction manuals are available from Springfield, Inc and at springfield-armory.com/resources.

Point firearm in a safe direction at all times.

6. This firearm will automatically be ready to fire again after each shot until all cartridges loaded in magazine have been fired. **NOTE:** This only applies when there is more than one round in magazine.
7. When last cartridge has been fired, slide will lock open and remain to rear.
8. Always re-engage safety after firing.

This is an auto loading firearm. It is immediately loaded and ready to fire again after each shot until all cartridges loaded in magazine have been fired. The firearm is able to fire both with and without the magazine in place. **REMOVING THE MAGAZINE DOES NOT UNLOAD THIS FIREARM NOR DOES IT ENGAGE A SAFETY. THIS FIREARM IS NOT UNLOADED UNTIL THE MAGAZINE IS REMOVED AND THE CHAMBER IS EMPTY.**



WARNING: Loading the **XD^F** by manually inserting a round in the chamber is improper and may cause accidental discharge and possible damage to the extractor. Always load the firearm using the magazine. When loading the firearm, always point the muzzle in a safe direction.

UNLOADING/CLEARING

If slide is already in “locked back” position: (See Figure 18)

1. Move thumb safety / decock lever to safe position (See Page 14).
2. **POINT FIREARM IN SAFE DIRECTION WHILE KEEPING YOUR FINGER OFF OF THE TRIGGER.**
3. Press magazine release button to remove magazine.
4. From above and rear, carefully inspect chamber to make sure it is empty.

When magazine has been removed and when chamber is empty, a firearm lock can be installed. (See Page 35, Figure 35) Firearm can now be safely stored in a secure place.



CAUTION: Do not cover the ejection port with your hand when loading/unloading your firearm.

Figure 18



Firearm is not empty or unloaded until the magazine is removed and the chamber is empty. To properly clear a firearm, remove the magazine, then pull slide back and check the chamber.

UNLOADING/CLEARING

If slide is forward:

1. Move thumb safety / decock lever to safe position (See Page 14).
2. **POINT FIREARM IN SAFE DIRECTION WHILE KEEPING YOUR FINGER OFF OF THE TRIGGER.**
3. Press magazine release button to remove magazine.
4. While holding slide in rearward (open) position, carefully inspect chamber making sure it is empty (See Figure 19).

When magazine has been removed and when chamber is empty, a firearm lock can be installed. (See Page 35, Figure 35) Pistol can now be safely stored in a secure place.

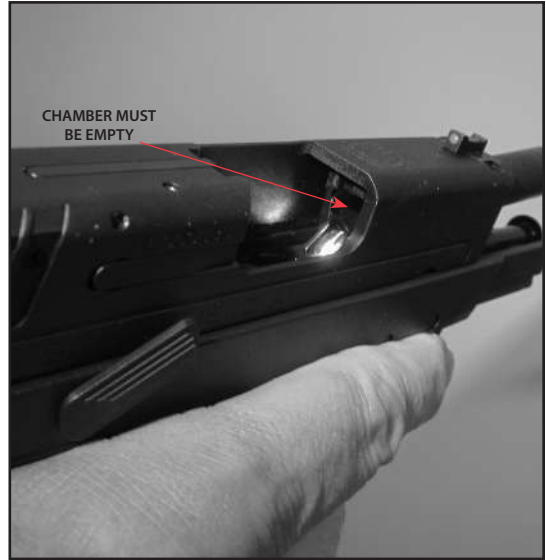

Figure 19



CAUTION: Do not cover the ejection port with your hand when loading/unloading your firearm.



WARNING

Firearm is not empty or unloaded until the magazine is removed and the chamber is empty. Never touch the trigger when loading or unloading the firearm.

MALFUNCTION WARNING!

If cartridge hangs up, jams or binds when being chambered from magazine into chamber, do not attempt to force it into the chamber by pushing or striking slide.

DO NOT COVER THE EJECTION PORT WITH YOUR HANDS WHEN LOADING/UNLOADING YOUR FIREARM.

1. Move thumb safety / decock lever to safe position (See Page 14).
2. What to do:
 - **Firmly hold firearm pointed in a safe direction while keeping your finger off of the trigger.**
 - Remove magazine.
 - Pull back on slide and allow cartridge to fall from firearm.
 - Do not cover the ejection port with your hands when loading / unloading your firearm.
 - If cartridge does not fall free, pull slide back and lock it back with slide stop.
 - Carefully dislodge cartridge.
 - If cartridge cannot be removed, lock slide back, carefully store your firearm and magazines and take it to a pistolsmith. (USE SUPPLIED CABLE LOCK). (See Page 35, Figure 35)
3. Most failures to feed or chamber a cartridge are the result of a damaged magazine, improper firearm handling or defective ammunition.
4. Whatever the cause, a jammed cartridge can be a dangerous situation.

If you have any questions concerning information in this manual, call Springfield's Consumer Safety Department at 1-800-680-6866 for assistance.



Figure 20



Always wear eye and ear protection when using any firearm.



Safety and instruction manuals are available from Springfield, Inc. and at springfield-armory.com/resources.



Always have firearm pointed in a safe direction. Failure to obey safety information may result in injury to you or others.

TO ELIMINATE MALFUNCTIONS

- First try changing type/brand of ammunition and/or magazine.
- If changing to another type/brand of ammunition and/or magazine does not at once result in smooth feeding of cartridges from magazine to chamber, the following steps should be taken:
 - Make certain chamber and magazine are unloaded. Magazine should be removed first. Check chamber to be sure it and magazine well are clear of cartridges.
 - Thoroughly clean magazine, paying particular attention to removing accumulated residue.
 - Thoroughly clean breech mechanism of firearm. Use a bristle brush and solvent to remove residue and fouling from breech face, extractor, chamber and feed ramp. (See **CARE AND CLEANING** section for detailed instruction).
- Check that magazine spring tension is adequate; the spring should hold the follower tightly against the lips of the magazine.
- Check that magazine lips are free of nicks and burrs and are not deformed.
- Remove excess oil and solvent from all cleaned components, load magazine and try firearm again.

 **WARNING** An obstructed, cracked, damaged barrel or some other damaged part should never be used and the firearm should be returned to Springfield for inspection.

FRONT FIBER OPTIC INSTALLATION



WARNING: Make sure the firearm is completely unloaded, magazine removed and chamber clear.
Move safety lever to safe position

INSTALLATION

- With a suitable heat source; i.e., Butane lighter, carefully begin to melt one end of the filament by positioning it close to the flame until a bulb forms the same size as the pocket in the serrated face of the front sight. **DO NOT LET THE FILAMENT TOUCH THE FLAME AS THIS WILL CLOUD THE BULB** (See Figure 22-1).
- Insert the filament into the sight from the serrated face of the sight and pull the filament through the sight until the bulb rests in the pocket (See Figure 22-2).
- If the bulb is larger than the pocket, cut off the bulb only and repeat the melting process until the bulb fits properly.
- Now cut the filament with a razor blade or fingernail clippers approximately 1/16 of an inch longer than the sight. Using the same melting process, form a bulb on the muzzle end of the sight locking the fiber optic filament in place (See Figure 22-3).



Figure 22-1



Figure 22-2



Figure 22-3

FIELD STRIP XD^E

NOTE: FIELD STRIPPING PROCEDURES ON THE XD-E™ ARE THE SAME REGARDLESS OF CALIBER.

Before performing any cleaning or maintenance, make sure the firearm is completely unloaded (this includes the magazine and chamber). Wear eye protection.

ALWAYS REMEMBER THE FIREARM IS ABLE TO FIRE WITH OR WITHOUT THE MAGAZINE IN PLACE.

1. Move thumb safety / decock lever to safe position (See Page 14).
2. **POINT FIREARM IN SAFE DIRECTION WHILE KEEPING FINGER OFF THE TRIGGER.**
3. Remove magazine and unload firearm.

4. Draw back the slide to the rear stop position and lock it open, pushing up the slide stop lever (See Figure 23-1).

NOTE: If step 3 is difficult, use this alternative method of locking slide to the most rearward position: Place **EMPTY** magazine in the magwell, pull slide completely to the rear until it locks back. Make sure the magazine is **EMPTY** or you will inadvertently load the firearm. Then remove magazine and proceed.



Figure 23-1



Figure 23-2

5. Visually inspect the chamber to confirm the firearm is unloaded.
6. Rotate the disassembly lever clockwise to a vertical 12 o'clock position (See Figure 23-2).



If you disassemble your Springfield Armory® firearm, do so properly. Improper disassembly and/or assembly will create unsafe conditions that could result in injury or death, or a firearm that simply will not work. Don't take chances. Do not attempt to disassemble this or any other firearm until you have received training and instructions from a competent pistolsmith.

FIELD STRIP^{XD}^E

Before performing any disassembly, point firearm in safe direction, make sure the firearm is completely unloaded (this includes the magazine and chamber). Wear eye protection. Move safety lever to safe position.

6. Pull the slide slightly to the rear to release the slide stop lever. Then, firmly gripping the slide, allow the slide to slowly move forward until the spring tension is released (See Figure 24-1).
7. Move the complete slide assembly forward and off the frame (See Figure 24-2).



CAUTION: Slide is under spring tension. Maintain control. Do not grip the slide in the area of the muzzle or ejection port.



Figure 24-1



Figure 24-2

FIELD STRIP XD^E

8. Remove the recoil system from the slide (See Figure 25-1).

 **CAUTION: Captive Recoil Spring System. Spring is under tension. Maintain control.**

9. Remove the barrel from the slide (See Figure 25-2).

The firearm is now fully field stripped and ready for cleaning.

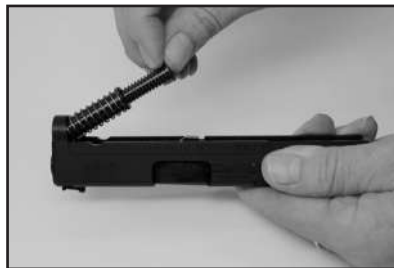

Figure 25-1



Figure 25-2

 **WARNING** Further dismantling is not necessary and should only be done by Springfield, Inc. or a qualified pistolsmith.



Safety and instruction manuals are available from Springfield, Inc and at springfield-armory.com/resources.



Always wear eye and ear protection when using any firearm.

REASSEMBLY XD^E

NOTE: REASSEMBLY PROCEDURES ON THE XD-E™ ARE THE SAME REGARDLESS OF CALIBER.



CAUTION: Never allow live ammunition in the area while you are maintaining your firearms.

1. Install barrel into slide (See Figure 26-1) insuring that the top of the chamber of the barrel is flush with the top of the slide (See Figure 26-2).
2. Reinstall the recoil system insuring it is properly aligned (Figure 26-3).

NOTE: IMPROPERLY ALIGNED RECOIL SYSTEM OR BARREL POSITION WILL CAUSE REASSEMBLY PROBLEMS. NEVER FORCE SLIDE ASSEMBLY ONTO FRAME.

3. Install the slide assembly onto the frame (See Figure 26-4).



Figure 26-1



Figure 26-2



Figure 26-3



Figure 26-3



Figure 26-4

REASSEMBLY XD^E



CAUTION: Never allow live ammunition in the area while you are maintaining your firearms.

If interference is encountered, remove the slide assembly and make sure the barrel is properly seated, the recoil system is properly aligned and the trigger is in its most rearward position.

NEVER FORCE SLIDE ASSEMBLY ONTO FRAME!
Doing so could cause damage to your firearm.

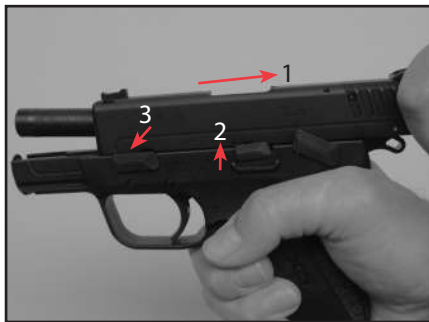

Figure 27

4. (See Figure 27) Move the slide to its most rearward position (1) (at this point spring resistance will be encountered) and move/push the slide stop up (2), locking the slide to the rear.
5. Rotate the disassembly lever counter-clockwise to the normal (locked) position (3).
6. Lower the slide.
7. Reassembly is now complete.

MAGAZINE DISASSEMBLY

NOTE: XD-E® DISASSEMBLY AND CLEANING PROCEDURE ARE THE SAME FOR ALL CALIBERS.

Disassembling and cleaning magazines every 3-4 months is normally sufficient, unless the magazines have been exposed to dirt or other adverse conditions or inspection indicates a need for cleaning.

Disassembly of the **XD^E** magazine is accomplished by depressing the magazine floor plate and sliding the base plate forward. (See Figure 28 for parts nomenclature).

NOTE: Make note of magazine spring orientation.

ALWAYS WEAR PROTECTIVE SAFETY GLASSES WHEN DISASSEMBLING OR REASSEMBLING ANY MAGAZINE.

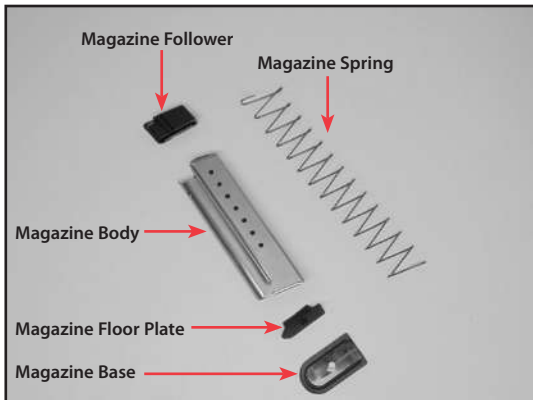

Figure 28



The magazine spring, follower, and inner floor plate are under spring tension, and can cause eye injury if not controlled during removal. Wear protective safety glasses to reduce the risk of eye injuries. Be sure to maintain downward pressure on the magazine spring, with your thumb, while disassembling.

XD^E POINTS OF LUBRICATION

NOTE: Please read entire manual and follow all safety rules before handling firearm.

1. Field Strip pistol. Only remove slide from frame (See page 24).
2. Using any quality firearm lubricant, 1 drop of lubricant on each side of the rear slide railways (See Figure 29-1).
3. Reassemble slide to frame (See page 26).
4. Manipulate slide back and forth 5 - 10 times.
5. 1 drop of lubricant on chamber area of the barrel (See Figure 29-2).
6. Lock slide to the rear.
7. 1 drop of lubricant on the top of the muzzle of the barrel, 1/4" from front top of muzzle and inside wall of slide (See Figure 29-3).
8. Manipulate slide back and forth 5 - 10 times.



Figure 29-1



Figure 29-2



Figure 29-3

SLIDE PARTS LIST (9MM)

- 2 Slide
- 3 Barrel
- 44 Firing Pin Safety Spring
- 45 Firing Pin Safety
- 46 Firing Pin Spring
- 47 Firing Pin
- 48 Firing Pin Roll Pin
- 49 Extractor
- 50 Extractor Spring
- 51 Extractor Roll Pin
- 52 Loaded Chamber Indicator Spring
- 53 Loaded Chamber Indicator
- 54 Loaded Chamber Indicator Pin
- 55 Rear Sight
- 56 Front Sight
- 57 Recoil Spring Assembly

XD^E FRAME PARTS LIST (9MM)

1 Receiver	20 Sear	37 Manual Safety Detent Plunger Spring
4 Locking Block	21 Sear Bushing	38 Manual Safety Detent Plunger
5 Locking Block Pin	22 Hammer	39 Manual Safety Pin Locking
6 Trigger Pin	23 Hammer Spring	40 Magazine Catch
7 Trigger Pin Safety	24 Hammer Spring Guide	41 Magazine Catch Pin
8 Trigger	25 Hammer Spring Support	42 Magazine Catch Spring
9 Trigger Spring	26 Hammer Bushing	43 Magazine Release Button
10 Slide Stop Lever Spring	27 Firing Pin Safety Lever	58 Magazine Body - 8 Round
11 Slide Stop Lever	28 Ejector	59 Magazine Spring - 8 Round
12 Trigger Bar Spring	29 Decocker	60 Magazine Follower
13 Trigger Bar	30 Decocker Spring	61 Magazine Follower Plate
14 Disassembler	31 Sear Roll Pin	62 Magazine Floor Plate
15 Sear Spring Pin	32 Hammer Housing Roll Pin	63 Magazine Base
16 Ejector Pin	33 Manual Thumb Safety Pin	64 Magazine Base - Extended
17 Hammer Housing	34 Manual Thumb Safety Slotted Pin	65 Magazine Body - 9 Round
18 Sear Spring	35 Manual Thumb Safety / Decock Lever - Left	66 Sleeve
19 Safety Sear	36 Manual Thumb Safety / Decock Lever - Right	

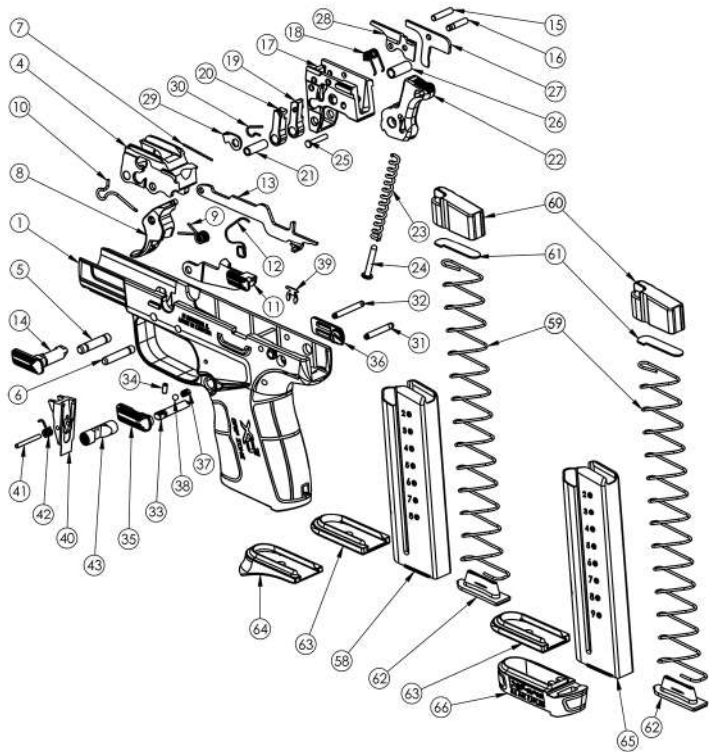

POINT OF AIM

Point of Impact

The users may use a “point of aim” sight picture at 25 yards (See Figure 36-1). This means that, at 25 yards, the bullet should impact the target at the point visible at the top of the front sight. Springfield, Inc. firearms are regulated to shoot point of aim, point of impact. Changing brand or type of ammunition may alter point of impact as well as user's technique.



CAUTION: Use only clean, dry, original, high-quality, commercially manufactured ammunition.

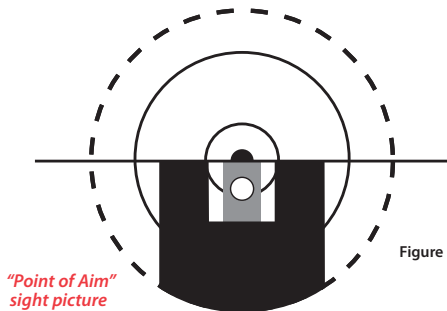



Figure 36-1

CABLE LOCK

- Step 1 - Point firearm in safe direction while keeping your finger off the trigger.
- Step 2 - Press magazine release and remove magazine.
- Step 3 - Pull slide fully to the rear and lock open.
- Step 4 - Check to see that no cartridge is in the chamber.
- Step 5 - Insert cable through the ejection port and out magazine well.
- Step 6 - Lock cable into cable lock.
- Step 7 - Grasp slide and ease forward.

 **CAUTION: FIREARMS SHOULD ALWAYS BE LOCKED AND STORED IN COMPLETE COMPLIANCE WITH ALL APPLICABLE LAWS AND REGULATIONS.**

This cable lock is supplied as an aid to your security measures.



Figure 35

CARE & CLEANING

KEEP YOUR FIREARM CLEAN AT ALL TIMES

Basic materials needed:

- Cleaning rod of proper size with bristle bore brushes (fiber or brass) and tip into which cleaning patch can be inserted.
- Cloth patches
- Powder solvent
- Lubricating oil
- Small lint-free cloths for wiping and oiling
- Bristle brush for scrubbing dirt off breech face, extractor, magazine lips, follower, etc.

Use proper size bore brushes and patches - if they are too small they won't do the job, and if they are too large they will bind inside bore.

When possible, insert cleaning rod from chamber end of barrel and push rod all the way through so it emerges from muzzle.

Do not "reverse" rod direction when patch or brush is in barrel, it might bind.

Do not use patches dripping with solvent or oil. Wet patches or brushes, then squeeze out excess before using.

When using bore brushes or a larger bristle brush on breech face, breech areas, magazines, etc., work carefully to prevent damaging components.

NOTE: *If lower parts of receiver and its mechanism are especially dirty, soak in appropriate solvent, flush clean with clean solvent. Make certain that all foreign matter is removed after cleaning. Lightly oil after cleaning.*

Only a very small amount of oil is needed to adequately lubricate moving parts and prevent rust. Accumulation of oil tends to attract dust and dirt which interferes with the safe and reliable functioning of firearm. DO NOT APPLY EXCESS LUBRICATING OIL. DO NOT APPLY OIL OR GREASE TO FIRING PIN.



Safety and instruction manuals are available from Springfield, Inc and at springfield-armory.com/resources.



Wear eye protection when using solvent. Thoroughly wash your hands to remove powder and solvents after cleaning your firearm.



Always wear eye and ear protection when using any firearm.

CLEANING FIREARM

1. Move thumb safety / decock lever to safe position.
2. Point firearm in safe direction.
3. Remove magazine and empty chamber.
4. Separate cartridges from firearm before cleaning operation.
5. Open slide and visually check that chamber and magazine well are free of cartridges.
6. Disassemble firearm as described in the **DISASSEMBLY** section.
7. Using cleaning rod, run solvent-wetted patch through barrel several times.
8. Attach solvent-wetted bristle brush to rod and run back and forth full length of barrel as needed until clean of residue.
9. Clean barrel with dry patches and examine it. If necessary, repeat barrel scrubbing. Barrel fouling can contribute to reduced accuracy, and residue accumulation in the chamber can interfere with proper feeding of cartridges from magazine.
10. Using powder solvent on a clean patch, remove powder residue from all components of mechanism. If residue cannot be removed by wiping with patch, use solvent-wetted bristle brush.
11. Next, wipe scrubbed areas with solvent-wetted patch.
12. After cleaning, run dry patch through barrel, then follow with lightly oiled patch.
13. Wipe all surfaces clean with cloth, then wipe all surfaces with lightly oiled patch (or cloth).
14. Reassemble firearm. Remember, an improperly assembled firearm is dangerous and should not be fired. Always consult a qualified pistolsmith if you experience any difficulty or have any questions concerning assembly procedure.
15. If firearm is to be stored for an extended period, final oil applications can be heavier so there will be less tendency for it to evaporate.
16. Keep your firearm clean at all times.

SPRINGFIELD ARMORY® LIMITED WARRANTY

This Limited Warranty is issued by Springfield, Inc., d/b/a Springfield Armory®, an Illinois corporation (“Springfield” or “we” or “us” or “our”) to “You” the original retail purchaser (also “YOUR”) of a Springfield product (the “Product”). This Limited Warranty gives You specific legal rights, and You may also have other rights which vary from state to state.

WHO AND WHAT IS COVERED BY THIS WARRANTY?

Springfield, Inc. warrants to You, the original retail purchaser of the Product, that the Product You purchased will be free of defects in workmanship or material, subject to the terms of this document.

HOW LONG WILL THIS WARRANTY LAST?

This Warranty will be in effect during the time that YOU, the original retail purchaser, own the product. Proof of original purchase required.

WHAT WILL SPRINGFIELD DO IF YOU DISCOVER A DEFECT?

If, during YOUR ownership of the Product, one or more parts of the Product fail due to defects in materials or workmanship, Springfield will provide, free of charge, a new, repaired or reconditioned (decided at our discretion) Product. That new, repaired or reconditioned Product will be warranted for the remainder of YOUR ownership of the Product under these same terms and conditions.

WHAT IS NOT COVERED BY THIS LIMITED WARRANTY?

This Limited Warranty does not cover any damage or condition determined by Springfield to be caused by: unauthorized repairs, disassembly, adjustments or modifications, carelessness, negligence, misuse, or unsafe handling, normal wear and tear, failure to properly or reasonably store, use, or maintain the product, hand-loaded, reloaded, remanufactured, or defective ammunition.

LIMITATION OF LIABILITY AND DISCLAIMERS

THIS LIMITED WARRANTY IS PROVIDED IN LIEU OF ANY AND ALL EXPRESS WARRANTIES. ALL IMPLIED WARRANTIES, INCLUDING IMPLIED WARRANTIES OF MERCHANTABILITY, NON-INFRINGEMENT AND FITNESS FOR A PARTICULAR PURPOSE, ARE LIMITED IN DURATION TO THE DURATION OF THE WARRANTY PERIOD (THE ORIGINAL PURCHASER'S (YOUR) OWNERSHIP OF THE PRODUCT) AND NO WARRANTIES, WHETHER EXPRESS OR IMPLIED, WILL APPLY AFTER SUCH PERIOD. SOME STATES DO NOT ALLOW LIMITATIONS ON THE DURATION OF AN IMPLIED WARRANTY, SO THE ABOVE LIMITATION MAY NOT APPLY TO YOU.

SPRINGFIELD'S RESPONSIBILITY FOR MALFUNCTIONS AND DEFECTS IN THE PRODUCT IS LIMITED TO THE TERMS SET FORTH IN THIS LIMITED WARRANTY. THE PRECEDING LIMITED WARRANTY CONSTITUTES SPRINGFIELD'S ONLY OBLIGATION TO YOU AND REPRESENTS YOUR EXCLUSIVE REMEDY AGAINST SPRINGFIELD. IN NO EVENT WILL SPRINGFIELD BE LIABLE FOR INCIDENTAL, SPECIAL OR CONSEQUENTIAL DAMAGES, REGARDLESS OF WHETHER YOUR CLAIMS ARE BASED ON BREACH OF CONTRACT, TORT (INCLUDING NEGLIGENCE AND STRICT LIABILITY) OR OTHER THEORIES, INCLUDING, WITHOUT LIMITATION, ANY LIABILITY FOR ECONOMIC LOSS, BODILY INJURY, PROPERTY DAMAGE OR FOR ANY DAMAGE THAT MAY RESULT FROM YOUR USE OR OWNERSHIP OF THE PRODUCT, WHETHER FORESEEABLE OR NOT. SOME STATES DO NOT ALLOW THE EXCLUSION OR LIMITATION OF INCIDENTAL OR CONSEQUENTIAL DAMAGES OR CERTAIN OTHER EXCLUSIONS CONTAINED IN WARRANTIES, SO THE ABOVE LIMITATIONS OR EXCLUSIONS MAY NOT APPLY TO YOU. THE LIMITATIONS SET FORTH IN THIS LIMITED WARRANTY SHALL NOT APPLY TO THE EXTENT THAT THEY ARE PROHIBITED BY LAW.

No person or entity is authorized to give any other warranty or to assume any other obligation on behalf of Springfield. Any provision of this Limited Warranty prohibited or unenforceable in any jurisdiction shall be ineffective only to the extent of such prohibition and shall not invalidate any of the remaining provisions of this Limited Warranty.

GOVERNING LAW/VENUE/CONSENT TO JURISDICTION

This Limited Warranty will be governed and construed in accordance with the law of the State of Illinois, without regard to Illinois' conflict of law rules. Any litigation between SPRINGFIELD and YOU or YOUR heirs, representatives or assigns shall be filed before a court of competent jurisdiction and venue in the 14th Judicial District of the State of Illinois. YOU HEREBY CONSENT TO THE IN PERSONAM JURISDICTION AND VENUE OF THE ILLINOIS COURTS, AND THAT SERVICE OF THE PROCESS MAY BE MADE UPON YOU AS PROVIDED BY ILLINOIS LAW.



Always wear eye and ear protection when using any firearm.



Safety and instruction manuals are available from
Springfield, Inc. and at springfield-armory.com/resources.

XDP
TM

SPRINGFIELD ARMORY® • 420 WEST MAIN STREET, GENESEO, IL 61254 • 800-680-6866