

A black and white photograph of a soldier in a white tactical suit, including a hood and gloves, aiming a rifle through a window. The soldier is in a crouched position, looking through the scope of the rifle. The background shows the interior of a building with a window frame and some structural elements.

# VICTRIX

A R M A M E N T S



## ***CREATORS OF PRECISION***

"When our new brand was launched, it naturally aroused much interest. Who was working on this project? Who were the technicians and engineers who make up Victrix Armaments? Who was managing the project? But most of all, who was really behind this ambitious venture? Indeed, who could take on such a major challenge?"

These are all valid questions but, is it not possible to truly understand the importance of our brand simply by asking who and how many are working on it?

I now welcome the opportunity to answer as many of these questions as I can and also to convey the real impetus behind our Company.

Behind Victrix Armaments are those most passionate about precision shooting.

Behind Victrix Armaments are individuals working at the highest level in the military arena, true experts in their particular field.

Behind Victrix Armaments are technicians and specialists in precision engineering and design who are prepared to explore all segments of their craft and expertise.

Why? After years acting as strategic partners to a large number of equipment manufacturers and particularly arms-producing companies and brands, we realised that it was now time for us to demonstrate our ability to manufacture a product without compromise and to honour our idea of precision firearms.

This is the core aim of Victrix Armaments – the will and determination to develop and manufacture new and safe generation of firearm systems for both sporting and military use without compromise.

Behind Victrix Armaments, are the men and women who have made all this possible. We are Victrix Armaments; we are creators of precision."

**Giuseppe Valtorta**  
**CEO and Founder**



**PASSION ACCURACY  
AND PERFECTION.**

**THESE ARE THE THREE MAIN  
VALUES OF VICTRIX ARMAMENTS**

Victrix Armaments, a Rottigni Company with over 45 years of experience in high precision engineering, we have developed unique manufacturing processes, which result in extremely close tolerances unparalleled in the firearms industry.

Victrix pride and experience: Where 45 years of traditional craftsmanship dovetails with modern technology.

**WHAT MAKES VICTRIX ARMAMENTS DIFFERENT**

At Victrix Armaments, we see ourselves as unique within the firearms industry, with the exception of the match grade barrel, all of the other components of the rifle have been designed and manufactured inside our company.

The advantage to this, of course, is that we are not reliant on other manufacturers for supply, quality and functionality. In maintaining this degree of control, we have analysed specific materials for their mechanical qualities and incorporated them into the design and manufacture of our rifles.



## INNOVATION AND DESIGN.

Every Victrix rifle is born in our in-house 3D modelling design department, where from inception to completion, each and every component is checked for its aesthetic design and functionality.



## MECHANICAL WORKING.

Our team of precision engineers and craftsmen have at their fingertips the most modern and sophisticated five axis CNC machining centres, spark erosion and EDM wire cutting equipment available to them.

Our actions are worked out directly from billet on high-technological CNC machining centres, to accomplish very low geometrical and dimensional tolerances and meet extremely high-quality standards. The alloy steel used allows to achieve high mechanical specifications. Treatment processes are carefully checked as they ensure long-lasting performance standards.

All actions single shot as well as those with magazines are equipped with a three-lug bolt thus assuring the highest precision.



## REVOLUTIONISED INSPECTION & ANALYSIS.

Our highly skilled and qualified technicians, using state-of-the-art measurement and test equipment guarantee the accuracy of every component.

Our laboratory is equipped with computerized tridimensional checking machining such as DEA, microscopes, roughness and roundness testers, tools for the analysis of hardness as well as manual measuring instruments. Testing and calibration measurements of all instruments and samples are performed in SIT laboratories.



## IT'S ALL IN THE DETAIL.

Attention to detail is paramount in the production of our precision rifles.

All of our components come together in our rifle building department, where each component is lovingly put together, with the emphasis on attention to detail, by our craftsmen, to produce what is known as the Victrix Precision Rifle. Victrix commands an unparalleled level of precision throughout its range.

We go straight to the heart of perfection.







**VICTRIX**  
A R M A M E N T S

 **MINERVA**  
TACTICAL



**Pugio**

*Scope and bipod are not included in the rifle configuration.*

Soft touch cheek-piece

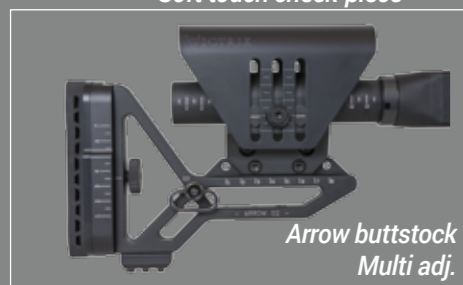

Arrow buttstock  
Multi adj.



Asymmetric  
3-lug bolt



- Top rail 20 MOA
- Oct. ellipt. forend



Detachable muzzle brake

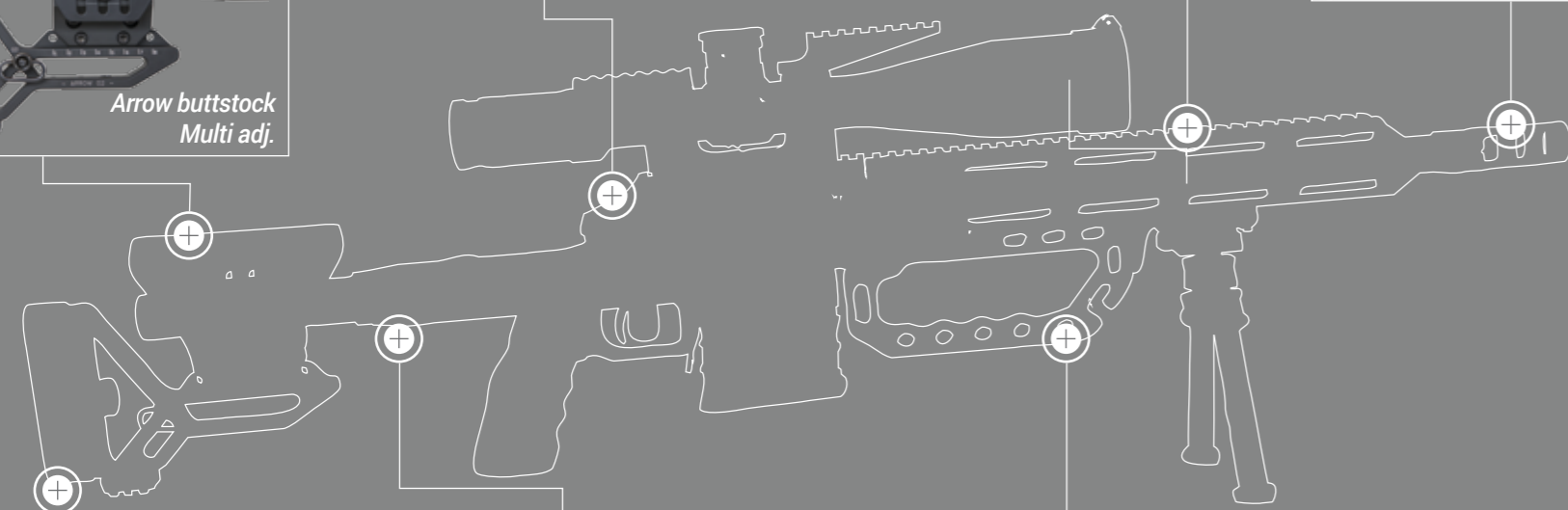

Monopod rail  
w/ QD sling attach.



Folding evo  
w/ open-closed lock. posit.



- Carry handle:**
- 2 size tripod attach.
  - Multi QD sling attach.
  - Helisniping rod attach.
  - The tripod attach. shown in the picture is only for example



FEATURES:

# Pugio

- /// Destination use: **Law Enforcement - Military**
- //// Caliber (Twist rate): **.308 Win (1/10)**
- ///// Barrel Length: **16"**

Destination Use	Law Enforcement - Military
Caliber (Twist rate)	.308 Win (1/10)
Barrel Length	16"
Barrel	Single cut in Aisi 416R lapped
Action	Minerva short 3-lug action in Aisi 630 w/ detach. magaz. PVD coated
Magazine	5 Rounds (compatible AI AICS system)
Magazine Optional	Polymer 8 Rounds - Metal 5 Rounds - Metal 10 Rounds (only MIL. / L.E. use)
Trigger	Double Stage - Adjust.
Safety	Upper
Muzzle Brake	3 Chambers Detachable
Action Rail	20 Moa
Buttstock	Arrow
Buttstock horiz. adj.	45 mm
Buttstock vert. adj.	60 mm

Monopod Rail	Stand. Equip. w/ QD sling attach.
Buttstock Optional	Advanced
Folding	Evo
Forend	Octagonal Elliptic
Forend Optional	Keymod
Top Rail	20 Moa
Side Rails	Standard Equipment only on Oct. Ellipt. forend
Bipod Rail	Standard Equipment w/ QD sling attach.
Carry Handle	Standard Equipment
Stock Colour	Hard Black Anodized
Colours Optional	\
Hard Case	Standard Equipment
Weight Gr.	5800
Dimension Min. / Max. mm	720 / 940







**VICTRIX**  
A R M A M E N T S

**MINERVA**  
T A C T I C A L



**Gladius TGT**

*The picture shows the model with 26" barrel.  
Scope and bipod are not included in the rifle configuration.*

Soft touch cheek-piece

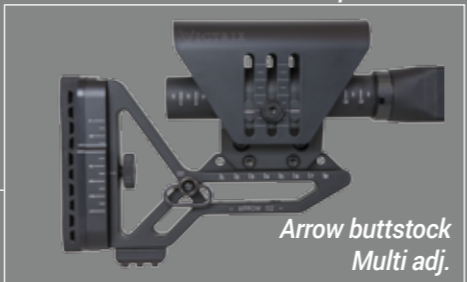

Arrow buttstock  
Multi adj.



Detachable muzzle brake

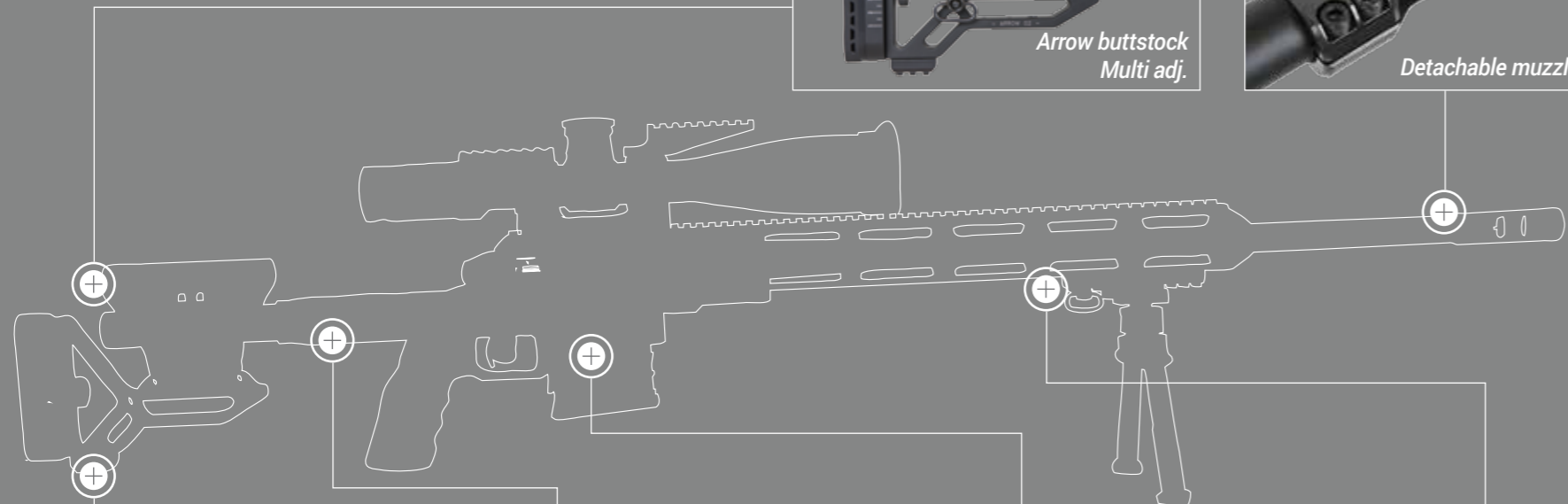

Monopod rail  
w/ QD sling attach.



Folding evo  
w/ open-closed lock. posit.



Magazine compatible AI AICS



Bipod rail w/ QD  
sling attach.

# Gladius TGT

/// Destination use: **Law Enforcement - Military - Tactical sporting shooting**

//// Caliber (Twist rate): **.308 Win (1/11) - .260 Rem (1/8,5) - 6,5 Creedmoor (1/8,5)**

///// Barrel Length: **22" - 26"**



**MINERVA**  
TACTICAL

Destination Use	Law Enforcement - Military - Tactical sporting shooting
Caliber (Twist rate)	.308 Win (1/11) - .260 Rem (1/8,5) - 6,5 Creedmoor (1/8,5)
Barrel Length	22"-26"
Barrel	Single cut in Aisi 416R lapped
Action	Minerva short 3-lug action in Aisi 630 w/ detach. magaz. PVD coated
Magazine	5 Rounds (compatible AI AICS system)
Magazine Optional	Polymer 8 Rounds - Metal 5 Rounds - Metal 10 Rounds (only MIL / L.E. use)
Trigger	Double Stage - Adjust.
Safety	Upper
Muzzle Brake	3 Chambers Detachable
Action Rail	20 Moa
Buttstock	Arrow
Buttstock horiz. adj.	45 mm
Buttstock vert. adj.	60 mm

Monopod Rail	Stand. Equip. w/ QD sling attach.
Buttstock Optional	Advanced
Folding	Evo
Forend	Round Elliptic
Top Rail	0 Moa
Side Rails	Optionals
Bipod Rail	Standard Equipment w/ QD sling attach.
Stock Colour	Hard Black Anodized
Colours Optional	\
Hard Case	Standard Equipment
Weight Gr.	6300 (22") - 6600 (26")
Dimension Min. / Max. mm	900 / 1125 (22") - 1000 / 1225 (26")



## FEATURES:

**BARREL LENGTH 22"-26"**

**DIMENSION MIN./MAX. mm 900 / 1125 (22") 1000 / 1225 (26")**

**WEIGHT Gr. 6300 (22") 6600 (26")**

*All screws are dark-treated inox steel*



**VICTRIX**  
A R M A M E N T S

 **MINERVA**  
TACTICAL



## Gladius TCT

*The picture shows the model with 22" barrel.  
Scope and bipod are not included in the rifle configuration.*

Soft touch cheek-piece



Advanced buttstock



Asymmetric 3-lug bolt



- Top rail 20 MOA
- Oct. ellipt. forend



Detachable muzzle brake

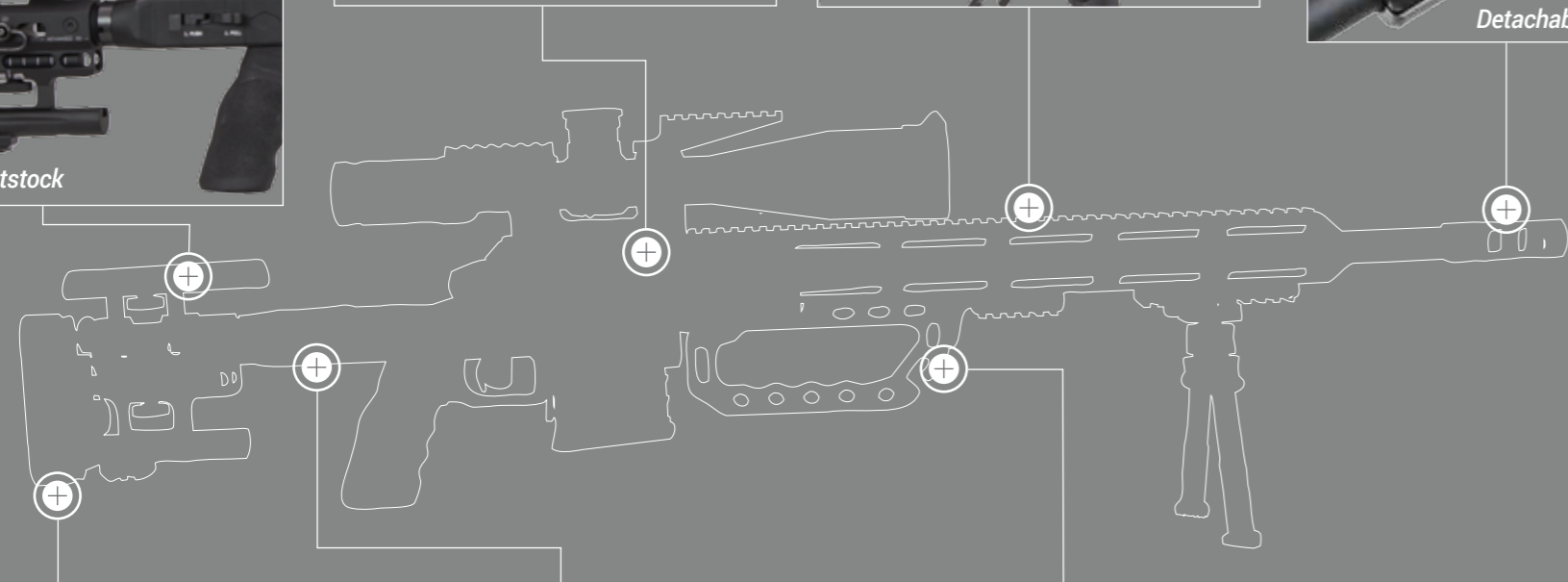

Folding evo w/ open-closed lock. posit.



- Carry handle:**
- 2 size tripod attach.
  - Multi QD sling attach.
  - Helisniping rod attach.
  - The tripod attach. shown in the picture is only for example

- Quick adjustment
- Monopod rail w/ QD sling attach.

FEATURES:

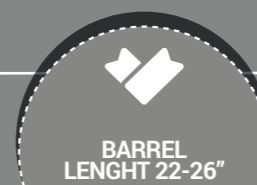

# Gladius TCT

- /// Destination use: **Law Enforcement - Military**
- //// Caliber (Twist rate): **.308 Win (1/11) - .260 Rem (1/8,5) - 6,5 Creedmoor (1/8,5)**
- ///// Barrel Length: **22" - 26"**



**MINERVA**  
TACTICAL

Destination Use	Law Enforcement - Military
Caliber (Twist rate)	.308 Win (1/11) - .260 Rem (1/8,5) - 6,5 Creedmoor (1/8,5)
Barrel Length	22"-26"
Barrel	Single cut in Aisi 416R lapped
Action	Minerva short 3-lug action in Aisi 630 w/ detach. magaz. PVD coated
Magazine	5 Rounds (compatible AI AICS system)
Magazine Optional	Polymer 8 Rounds - Metal 5 Rounds - Metal 10 Rounds (only MIL. / L.E. use)
Trigger	Double Stage - Adjust.
Safety	Upper
Muzzle Brake	3 Chambers Detachable
Action Rail	20 Moa
Buttstock	Advanced
Buttstock horiz. adj.	50 mm
Buttstock vert. adj.	60 mm

Monopod Rail	Stand. Equip. w/ QD sling attach.
Folding	Evo
Forend	Octagonal Elliptic
Forend Optional	Keymod
Top Rail	20 Moa
Side Rails	Standard Equipment only on Oct. Ellipt. forend
Bipod Rail	Standard Equipment w/ QD sling attach.
Carry Handle	Standard Equipment
Stock Colour	Hard Black Anodized
Colours Optional	TAN (action, barrel, muzzle brake, cheek piece, magazine, screws and rails: BLACK)
Hard Case	Standard Equipment
Weight Gr.	6400 (22") - 6700 (26")
Dimension Min. / Max. mm	900 / 1125 (22") - 1000 / 1225 (26")



All screws are dark-treated inox steel



**VICTRIX**  
A R M A M E N T S



**MINERVA**  
TACTICAL



## Scorpio TGT

*The picture shows the model with 26" barrel.  
Scope and bipod are not included in the rifle configuration.  
Metal magazine optional.*

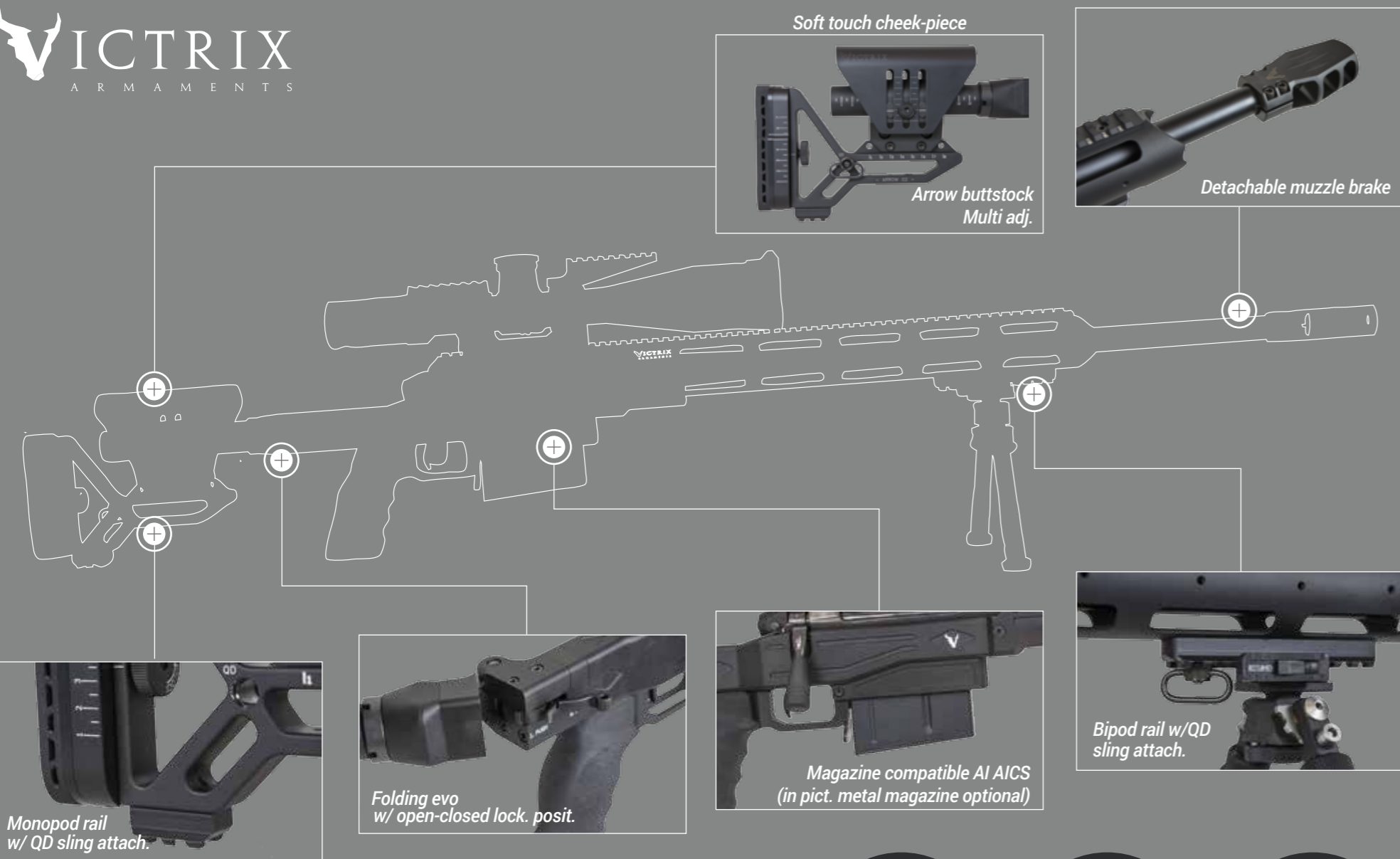

# Scorpio TGT

/// Destination use: **Law Enforcement - Military - Tactical sporting shooting**

//// Caliber (Twist rate): **.338 Lapua Magnum (1/10) - .300 Win Mag (1/10) 300 Norma Mag. (1/10)**

///// Barrel Length: **22" - 26"**

Destination Use	Law Enforcement - Military - Tactical sporting shooting
Caliber (Twist rate)	.338 Lapua Magnum (1/10) - .300 Win Mag (1/10) - 300 Norma Mag. (1/10)
Barrel Length	22" - 26"
Barrel	Single cut in Aisi 416R lapped
Action	Minerva long 3-lug action in Aisi 630 w/ detach. magaz. PVD coated
Magazine	5 Rounds (compatible AI AICS system)
Magazine Optional	Polymer 8 Rounds - Metal 5 Rounds (only MIL. / L.E. use)
Trigger	Double Stage - Adjust.
Safety	Upper
Muzzle Brake	3 Chambers Detachable
Action Rail	20 Moa
Buttstock	Arrow
Buttstock horiz. adj.	45 mm
Buttstock vert. adj.	60 mm

Monopod Rail	Stand. Equip. w/ QD sling attach.
Buttstock Optional	Advanced
Folding	Evo
Forend	Round Elliptic
Top Rail	0 Moa
Side Rails	Optionals
Bipod Rail	Standard Equipment w/ QD sling attach.
Stock Colour	Hard Black Anodized
Colours Optional	\
Hard Case	Standard Equipment
Weight Gr.	6600 (22") - 6950 (26")
Dimension Min. / Max. mm	940 / 1170 (22") - 1020 / 1260 (26")



## FEATURES:

**BARREL LENGTH 22-26"**

**DIMENSION MIN./MAX. mm 940 / 1170 (22") 1020 / 1260 (26")**

**WEIGHT Gr. 6600 (22") 6950 (26")**

*All screws are dark-treated inox steel*



**VICTRIX**  
ARMAMENTS

**MINERVA**  
TACTICAL



## Scorpio TCT

*The picture shows the model with 22" barrel TAN colour finished.  
Scope and bipod are not included in the rifle configuration.  
Metal magazine optional.*

Soft touch cheek-piece



Advanced buttstock



Asymmetric 3-lug bolt



- Top rail 20 MOA
- Oct. ellipt. forend



Detachable muzzle brake

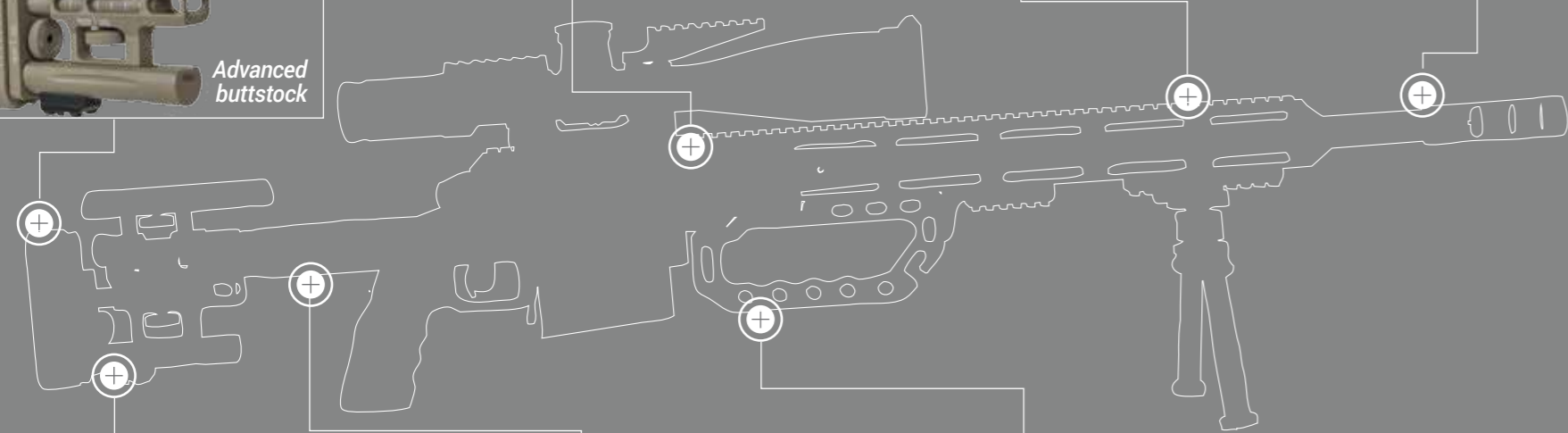

Folding evo w/ open-closed lock. posit.



- Carry handle:
- 2 size tripod attach.
  - Multi QD sling attach.
  - Helisniping rod attach.
  - Rear bipod rail

- Quick adjustment
- Monopod rail w/ QD sling attach.

FEATURES:



TAN COLOUR AVAILABLE



BARREL LENGTH 22-26"



DIMENSION MIN./MAX. mm  
940 / 1170 (22")  
1020 / 1260 (26")



WEIGHT Gr.  
6700 (22")  
7050 (26")

# Scorpio TCT

/// Destination use: **Law Enforcement - Military**

//// Caliber (Twist rate): **.338 Lapua Magnum (1/10) - .300 Win Mag (1/10) 300 Norma Mag. (1/10)**

///// Barrel Length: **22" - 26"**

Destination Use	Law Enforcement - Military
Caliber (Twist rate)	.338 Lapua Magnum (1/10) - .300 Win Mag (1/10) - 300 Norma Mag. (1/10)
Barrel Length	22" - 26"
Barrel	Single cut in Aisi 416R lapped
Action	Minerva long 3-lug action in Aisi 630 w/ detach. magaz. PVD coated
Magazine	5 Rounds (compatible AI AICS system)
Magazine Optional	Polymer 8 Rounds - Metal 5 Rounds (only MIL. / L.E. use)
Trigger	Double Stage - Adjust.
Safety	Upper
Muzzle Brake	3 Chambers Detachable
Action Rail	20 Moa
Buttstock	Advanced
Buttstock horiz. adj.	50 mm
Buttstock vert. adj.	60 mm

Monopod Rail	Stand. Equip. w/ QD sling attach.
Folding	Evo
Forend	Octagonal Elliptic
Forend Optional	Keymod
Top Rail	20 Moa
Side Rails	Standard Equipment only on Oct. Ellipt. forend
Bipod Rail	Standard Equipment w/ QD sling attach.
Carry Handle	Standard Equipment
Stock Colour	Hard Black Anodized
Colours Optional	TAN (action, barrel, muzzle brake, cheek piece, magazine, screws and rails: BLACK)
Hard Case	Standard Equipment
Weight Gr.	6700 (22") - 7050 (26")
Dimension Min. / Max. mm	940 / 1170 (22") - 1020 / 1260 (26")



All screws are dark-treated inox steel





**VICTRIX**  
A R M A M E N T S

 **MINERVA**  
TACTICAL



## Tormentum

*The picture shows the model TAN colour finished.  
Scope and bipod are not included in the rifle configuration.*

Soft touch cheek-piece



Advanced buttstock



3-lug bolt



- Top rail 45 MOA
- Full length side rail



Detachable muzzle brake / fluted barrel

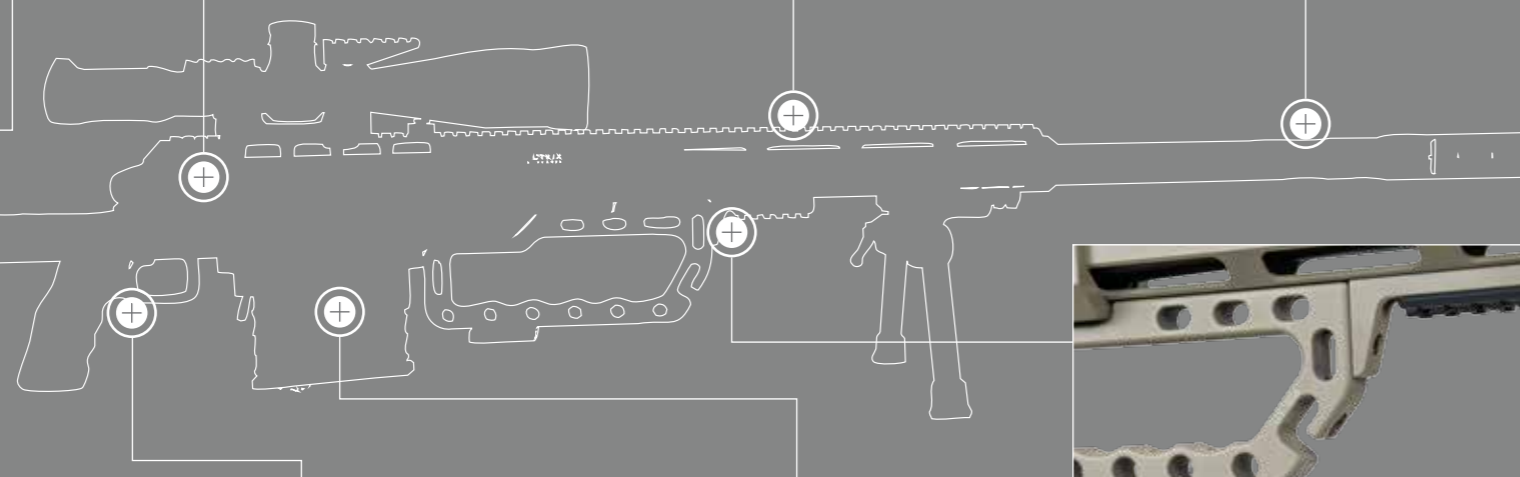

Folding evo w/ open-closed lock. posit.



5 rounds polymer magazine



- Carry handle:
- 2 size tripod attach.
  - Multi QD sling attach.
  - Helisniping rod attach.
  - Rear bipod rail

- Quick adjustment
- Monopod rail w/ QD sling attach.

FEATURES:

- MINIMIZED RECOIL**
- BARREL LENGHT 30"**
- DIMENSION MIN./MAX. mm 1230 / 1450**
- .375 CT / .408 CT**

# Tormentum

- /// Destination use: **Law Enforcement - Military - Extreme long range shooting**
- //// Caliber (Twist rate): **.375 Cheytac (1/10) - .408 Cheytac (1/13)**
- ///// Barrel Length: **30"**



**MINERVA**  
TACTICAL

Destination Use	Law Enforcement - Military - Extreme long range shooting	Monopod Rail	Stand. Equip. w/ QD sling attach.
Caliber (Twist rate)	.375 Cheytac (1/10) - .408 Cheytac (1/13)	Folding	Evo
Barrel Length	30"	Forend	Octagonal Elliptic
Barrel	Single cut in Aisi 416R lapped FLUTED	Top Rail	45 Moa
Action	Marte CT 3-lug action in Aisi 630 w/ detach. magaz. PVD coated	Side Rails	Standard Equipment full lenght
Magazine	5 Rounds	Bipod Rail	Standard Equipment w/ QD sling attach.
Magazine Optional	Polymer 7 Rounds (limitable capacity by 5 rounds) (only MIL. / L.E. use)	Carry Handle	Standard Equipment
Trigger	Double Stage - Adjust.	Stock Colour	Hard Black Anodized
Safety	Upper	Colours Optional	TAN (action, barrel, muzzle brake, cheek piece, magazine, screws and rails; BLACK)
Muzzle Brake	3 Chambers Detachable	Hard Case	Standard Equipment
Action Rail	45 Moa	Weight Gr.	12700
Buttstock	Advanced	Dimension Min. / Max. mm	1230 / 1450
Buttstock horiz. adj.	50 mm		
Buttstock vert. adj.	60 mm		

All screws are dark-treated inox steel



**VICTRIX**  
A R M A M E N T S

**VICTORIA**  
SPORT



**Target Series**

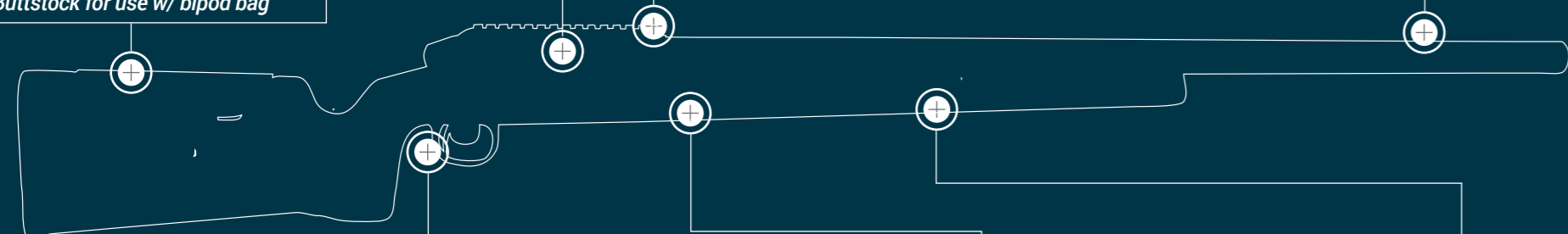
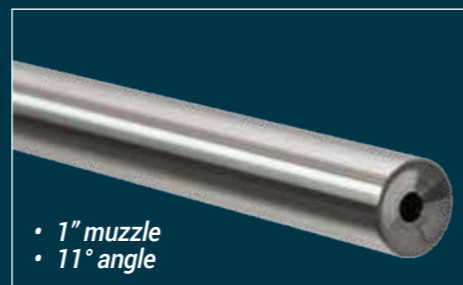
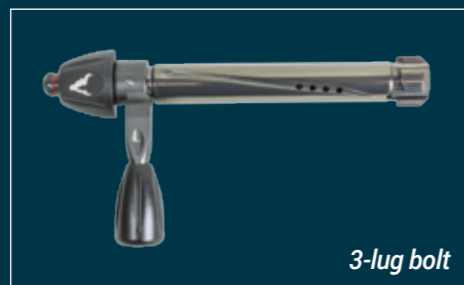

# Target Series

/// Destination use: **Sporting by bipod / bag**

//// Caliber: **.300 WSM - .308 Win Match - .308 Win - .284 Win - 7/270 WSM - 6,5 Creedmoor - 6,5x47 Lapua - 6 XC - 6 BR -**

Destination Use	<b>Sporting by bipod/bag</b>
Caliber (Twist rate)	.300 WSM (1/10 - 32") - .308 Win Match (1/11 - 30") - .308 Win Match (1/10 - 32") - .308 Win (1/11 - 30") - .284 Win (1/8,5 - 32") - 7/270 WSM (1/8,5 - 32") - 6,5 Creedmoor (1/8,5 - 30") - 6,5x47 Lapua (1/8,5 - 30") - 6 XC (1/8,5 - 28") - 6 BR (1/8,5 - 28")
Barrel Length	See caliber
Barrel	Single cut in Aisi 416R lapped - 1" muzzle
Action	Victoria 3-lug action single shot in Aisi 630 PVD coated (std: right port - right bolt)
Action optional	Left version: left port-right bolt
Trigger	4-lever Single Stage
Action Rail	20 Moa
Buttpad horizontal adj.	Optional
Buttpad vertical adj.	Optional
Bipod Rail	Standard Anschütz

Monoblock system	Standard Equipment
Hard Case	Standard Equipment
Weight Gr.	6620 (28") - 6750 (30") - 6890 (32") (Walnut - 160gr)
Dimension mm	1300
Stock Colour	Blue Laminate - Grey Laminate - Red Laminate - Solid Walnut oil finished
Colours Optional	All stocks of the Victoria series are swappable.



## FEATURES:

ACTION LEFT VERSION AVAILABLE

DESIGNED FOR BIPOD / BAG

WEIGHT Gr.  
6620 (28")  
6750 (30")  
6890 (32")  
(Walnut - 160 Gr.)

BARREL LENGTH  
28" - 30" - 32"

MONOBLOCK SYSTEM



**VICTRIX**  
A R M A M E N T S

**VICTORIA**  
S P O R T



## Absolute Series

*The picture shows the model with buttpad horizontal adjustment optional.*

Buttpad horizontal adj. optional



- Adjustable cheek-piece
- Buttstock for use w/ rest bag

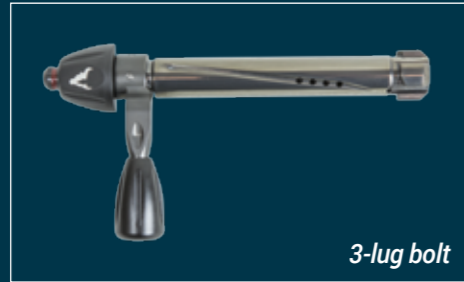

3-lug bolt



Action rail 20 MOA

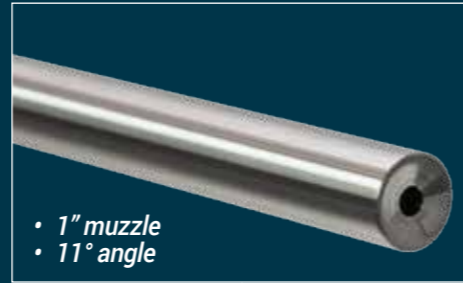

- 1" muzzle
- 11° angle

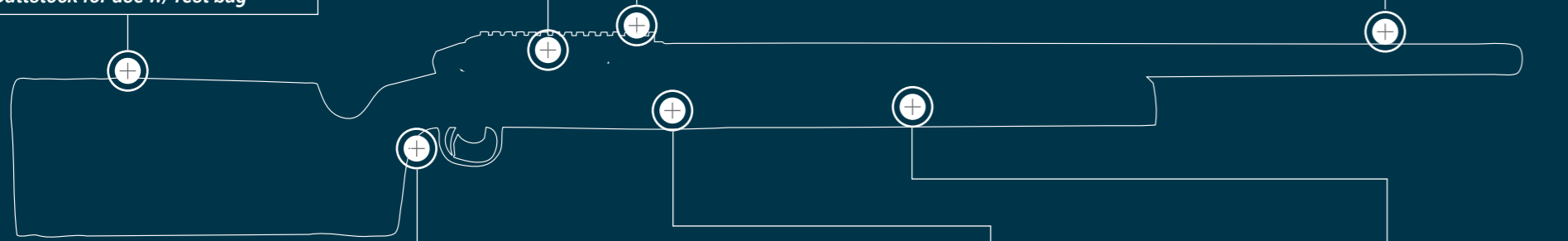

4-lever trigger



Integrated stabilizer plate



Monoblock system

# Absolute Series

- /// Destination use: **Sporting by rest**
- //// Caliber: **.300 WSM - .308 Win Match - .308 Win - .284 Win - 7/270 WSM - 6,5 Creedmoor - 6,5x47 Lapua - 6 XC - 6 BR -**



**VICTORIA**  
SPORT

Destination Use	<b>Sporting by rest</b>
Caliber (Twist rate)	.300 WSM (1/10 - 32") - .308 Win Match (1/11 - 30") - .308 Win Match (1/10 - 32") - .308 Win (1/11 - 30") - .284 Win (1/8,5 - 32") - 7/270 WSM (1/8,5 - 32") - 6,5 Creedmoor (1/8,5 - 30") - 6,5x47 Lapua (1/8,5 - 30") - 6 XC (1/8,5 - 28") - 6 BR (1/8,5 - 28")
Barrel Length	See caliber
Barrel	Single cut in Aisi 416R lapped - 1" muzzle
Action	Victoria 3-lug action single shot in Aisi 630 PVD coated (std: right port - right bolt)
Action optional	Left version: left port-right bolt
Trigger	4-lever Single Stage
Action Rail	20 Moa
Buttpad horizontal adj.	Optional
Buttpad vertical adj.	Standard equipment
Bipod Rail	Use by Rest

Monoblock system	Standard Equipment
Hard Case	Standard Equipment
Weight Gr.	8640 (28") - 8780 (30") - 8920 (32") (Walnut - 230gr)
Dimension mm	1330
Stock Colour	Blue Laminate - Grey Laminate - Red Laminate - Solid Walnut oil finished
Colours Optional	All stocks of the Victoria series are swappable.

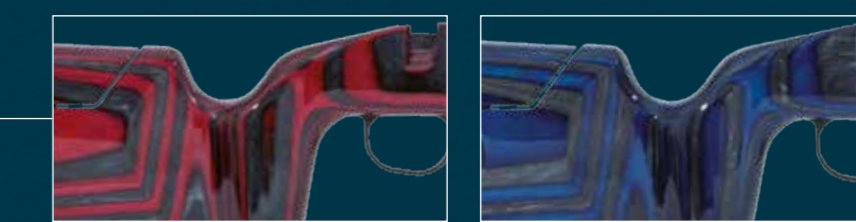

## FEATURES:

ACTION LEFT VERSION AVAILABLE

DESIGNED FOR REST / BAG

WEIGHT Gr.  
8640 (28")  
8780 (30")  
8920 (32")  
(Walnut - 230 Gr.)

BARREL LENGTH  
28" - 30" - 32"

MONOBLOCK SYSTEM



**VICTRIX**  
A R M A M E N T S

**VICTORIA**  
S P O R T

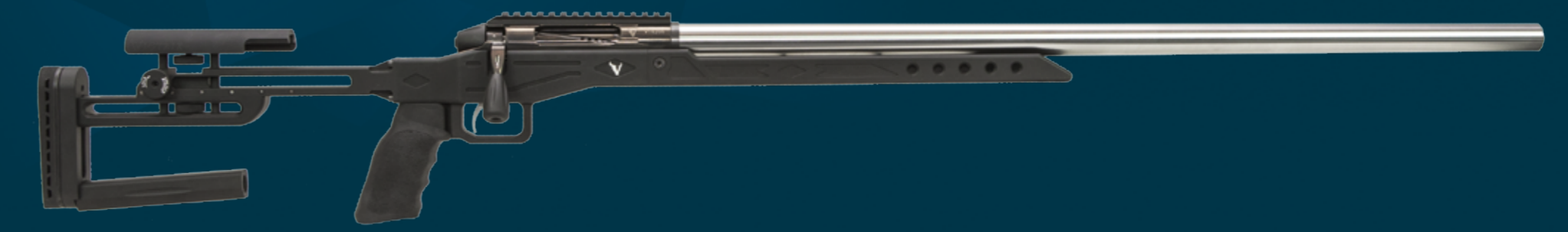

**Sport Series**

*The picture shows the target model for bipod use.  
"Target" buttstock and forend.*

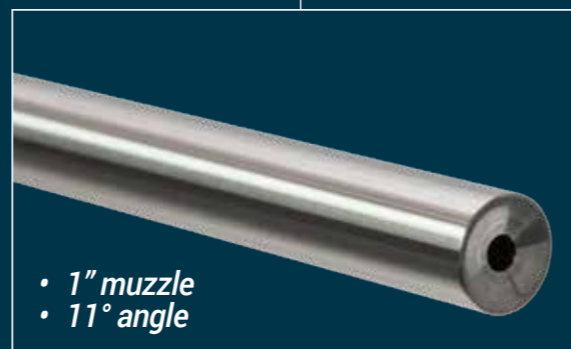
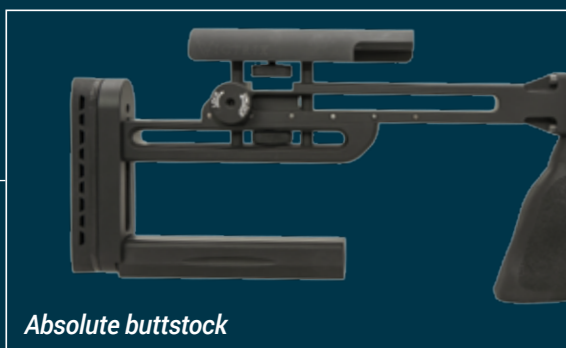
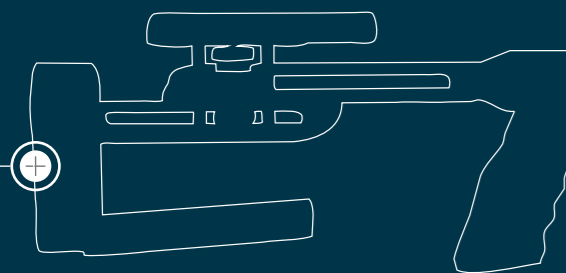
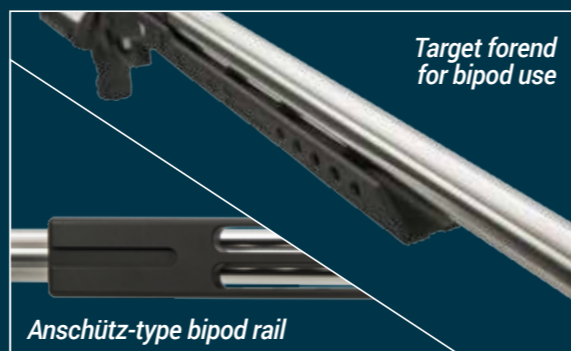
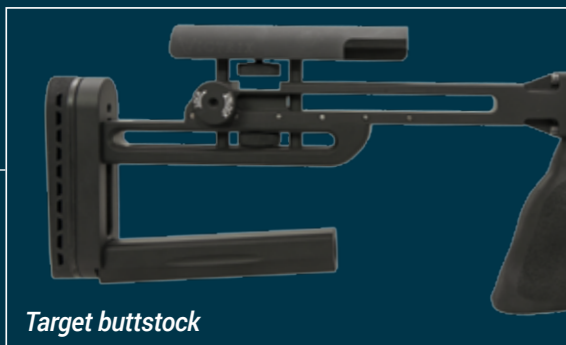

# Sport Series

/// Destination use: **Sporting bipod/bag - rest**

//// Caliber: **.300 WSM - .308 Win Match - .308 Win - .284 Win - 7/270 WSM - 6,5 Creedmoor - 6,5x47 Lapua - 6 XC - 6 BR -**



**VICTORIA**  
SPORT

Destination Use	<b>Sporting by bipod/bag - rest</b>
Caliber (Twist rate)	.300 WSM (1/10 - 32") - .308 Win Match (1/11 - 30") - .308 Win Match (1/10 - 32") - .308 Win (1/11 - 30") - .284 Win (1/8,5 - 32") - 7/270 WSM (1/8,5 - 32") - 6,5 Creedmoor (1/8,5 - 30") - 6,5x47 Lapua (1/8,5 - 30") - 6 XC (1/8,5 - 28") - 6 BR (1/8,5 - 28")
Barrel Length	See caliber
Barrel	Single cut in Aisi 416R lapped - 1" muzzle
Action	Victoria 3-lug action single shot in Aisi 630 PVD coated (std: right port - right bolt)
Action optional	Left version: left port-right bolt
Trigger	4-lever Single Stage
Action Rail	20 Moa
Buttstock	Target
Horizontal Adjustment	Standard Equipment
Vertical Adjustment	Standard Equipment



Buttstock Optional	Absolute for rest / bag use
Forend	Target for bipod use
Forend Optional	Absolute for rest / bag use
Bipod Rail	Standard Anschütz (only for target forend)
Stock Colour	Hard Black Anodized
Colours Optional	All stocks of the Victoria series are swappable.
Hard Case	Standard Equipment
Weight Gr.	6610 (28") - 6750 (30") - 6890 (32")
Dimension mm	1300

## FEATURES:

**ACTION LEFT VERSION AVAILABLE**

**WEIGHT Gr.**  
6610 (28")  
6750 (30")  
6890 (32")

**BARREL LENGTH**  
28" - 30" - 32"

**FMRC CHASSIS**





**VICTRIX**  
A R M A M E N T S

**VICTORIA**  
S P O R T



**Carbon performance**

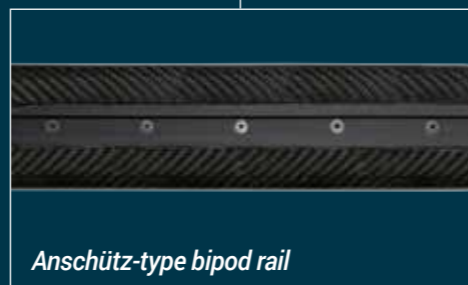
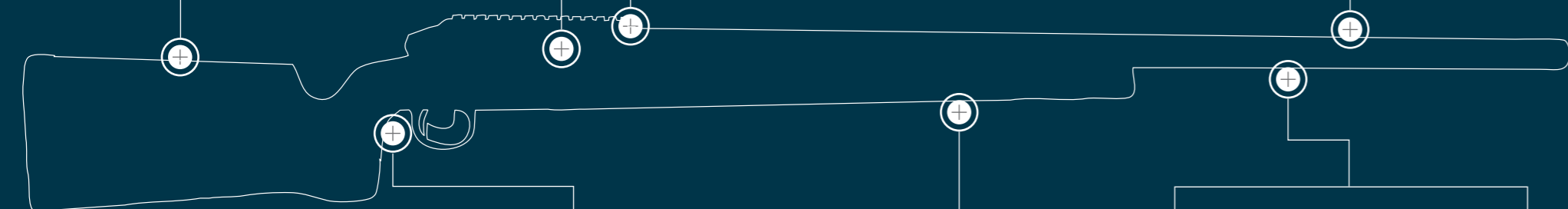
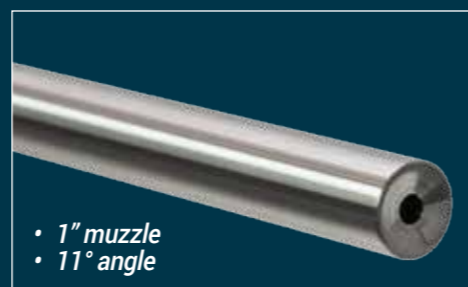

# Carbon performance

/// Destination use: **Sporting bipod/bag - rest**  
 //// Caliber: **.300 WSM - .308 Win Match - .308 Win - .284 Win - 7/270 WSM - 6,5 Creedmoor - 6,5x47 Lapua - 6 XC - 6 BR -**



**VICTORIA**  
SPORT

Destination Use	<b>Sporting by bipod/bag</b>
Caliber (Twist rate)	.300 WSM (1/10 - 32") - .308 Win Match (1/11 - 30") - .308 Win Match (1/10 - 32") - .308 Win (1/11 - 30") - .284 Win (1/8,5 - 32") - 7/270 WSM (1/8,5 - 32") - 6,5 Creedmoor (1/8,5 - 30") - 6,5x47 Lapua (1/8,5 - 30") - 6 XC (1/8,5 - 28") - 6 BR (1/8,5 - 28")
Barrel Length	See caliber
Barrel	Single cut in Aisi 416R lapped - 1" muzzle
Action	Victoria 3-lug action single shot in Aisi 630 PVD coated (std: right port - right bolt)
Action optional	Left version: left port-right bolt
Trigger	4-lever Single Stage
Action Rail	20 Moa
Buttpad horizontal adj.	Optional
Buttpad vertical adj.	Optional
Bipod Rail	Standard Anschütz

Monoblock system	Standard Equipment
Stock Colour	Visible Carbon Fiber matt
Colours Optional	All stocks of the Victoria series are swappable.
Hard Case	Standard Equipment
Weight Gr.	6030 (28") - 6180 (30") - 6350 (32")
Dimension mm	1300



## FEATURES:

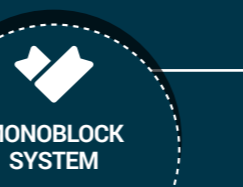
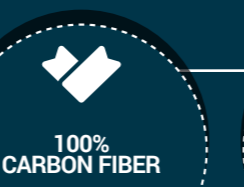



**VICTRIX**  
A R M A M E N T S

**LUNAE**  
HUNTING



**Lunae**

*The picture shows the model with 22" barrel*

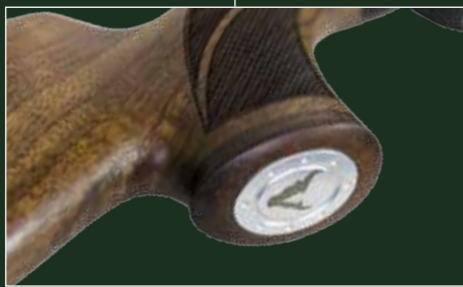
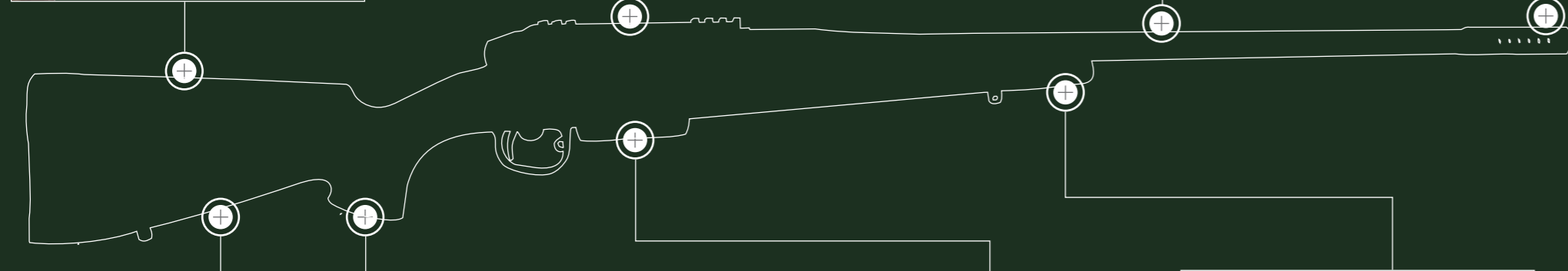

FEATURES:

- WEIGHT Gr.**  
3150 (22")  
3350 (26")
- BARREL LENGHT**  
22" - 26"
- 3-LUG BOLT**
- MONOBLOCK SYSTEM**

# Lunae

/// Destination use: **Hunting**  
 /// Caliber: **.300 WM - 7 Rem Mag - .270 WSM - .308 Win - 6 XC -**

Destination Use	Hunting	Muzzle Brake	Radial Detachable
Caliber (Twist rate)	.300 WM (1/10 - 26") - 7 Rem Mag (1/8,5 - 26") - .270 WSM (1/9 - 26") - .308 Win (1/11 - 22") - 6 XC (1/8,5 - 22")	Action Rail	20 Moa
Barrel Length	22" - 26"	Bipod Rail	Sling Attach.
Barrel	Single cut in Aisi 416R lapped FLUTED	Monoblock system	Standard equipment
Action	Lunae 3-lug action in Aisi 630 w/ detachable magazine PVD coated	Stock Colour	Solid Walnut premium grade oil finished
Magazine	Metal 3 Rounds	Hard Case	Standard Equipment
Trigger	Double Stage - Adjust.	Weight Gr.	3150 (22") - 3350 (26")
Safety	Upper	Dimension Min. / Max. mm	1100 (22") - 1200 (26")



**LUNAE**  
HUNTING





VICTRIX

A R M A M E N T S

[info@victrixarmaments.com](mailto:info@victrixarmaments.com)

Catalogue 2017/0

The contents indicated in this catalogue may be subject to modifications without notice.

# VICTRIX

A R M A M E N T S



---

[www.victrixarmaments.com](http://www.victrixarmaments.com)  
[www.beretta.com](http://www.beretta.com)  
[www.berettadefensetechnologies.com](http://www.berettadefensetechnologies.com)