

STEINER

Nothing Escapes You



2019 DEALER WORKBOOK

**WORLD-CLASS
GERMAN ENGINEERING**

In 1947, Karl Steiner started a one-man workshop in Bayreuth, Germany, obsessed with a single goal: creating optical products so functional, sturdy and uniformly flawless that nothing in the world could compare.

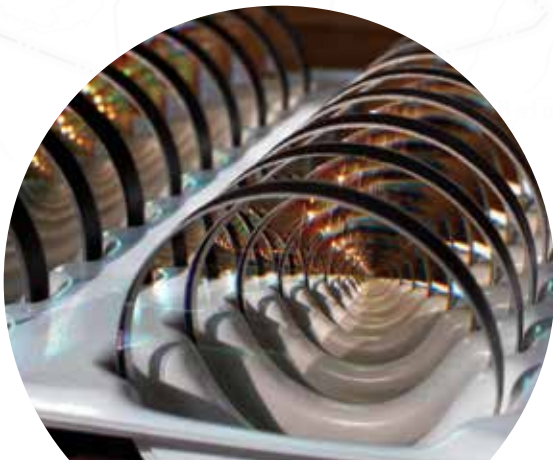

RAZOR-SHARP IMAGE CLARITY

100% IN-HOUSE OPTICS - Steiner grinds and polishes its own premium lenses and BaK4 prisms.

PROPRIETARY COATINGS - Steiner advanced lens coatings are applied to every air/glass surface to enhance light so your eyes perceive more contrast and brighter detail, even in low-light conditions.

**BLASTED BY AN IED IN IRAQ...
STILL WORKING**

These binoculars came out charred and misshapen, armor and chassis disfigured by fire and impact - but still working with the lens and prism systems intact.

**OVER 72,000
STEINER M22 BINOCULARS**

have served the U.S. military. When all is on the line, people around the world rely on Steiner, so can you.





PRECISION MANUFACTURING

Steiner's state-of-the-art manufacturing facilities employ more than 460 high-precision manufacturing and inspection steps ensuring the highest quality product every time.

INSIDE

RIFLESCOPES | 4

BINOCULARS | 32

EOPTICS | 64

ACCESSORIES | 89

ERGONOMIC DESIGN

Designed to maximize form and function, Steiner's binoculars and scopes are ergonomically perfect because the world never is.



LEGENDARY DURABILITY

Battle-proven technology is integrated into every Steiner product making them world-renowned for their toughness. Our binoculars are fortified with an unbreakable Makralon housing and our scopes are made from high-grade aluminum impact tested to 900 Gs.

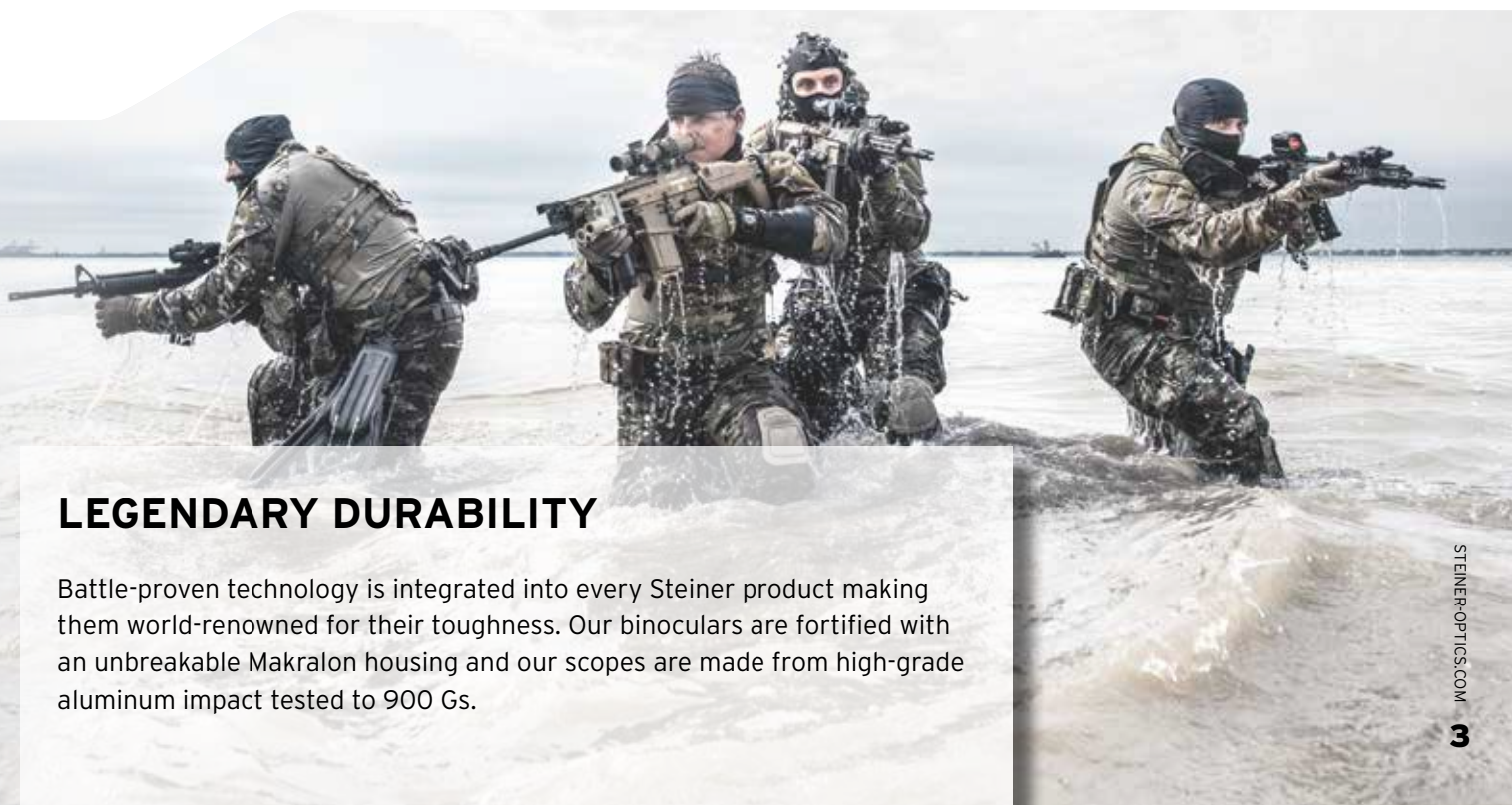



STEINER RIFLESCOPES



RIFLESCOPES FEATURES | 6
GS3 | 8
H4Xi | 10
P-SERIES | 12
T-SERIES | 14
M-SERIES | 16

DRS1X | 22
SIGHTS | 24
ICS | 26
MRS | 28
MOUNTS | 29
RETICLES | 32

Riflescope Technology

For over 70 years, Steiner-Optik in Bayreuth, Germany has set the bar in premium rifle optics. Over 460 exacting steps ensure rigorous quality throughout design and manufacture. Relentless innovation creates technologies like the N2 Injection™ System, Steiner Nano-Protection®, and Neverlost Turrets. No optic will serve you better.



FEATURES:

NEW 6X AND 7X ZOOM SYSTEMS

Steiner now offers 4x up to 7x zoom systems providing the perfect solution for your application. These systems provide maximum range at the high end, wider field of view at the low end, and eliminates any tunneling effect to deliver the best image possible to your eye.

PRECISION ADJUSTMENT SYSTEMS

Pinpoint accuracy is easily achieved with Steiner windage and elevation adjustment systems. Adjustment clicks are firm and audible. Tactical riflescopes have large, oversized knobs with easy-to-grip designs that allow for positive, non-slip adjustments.



RUGGED CONSTRUCTION

Steiner scope tubes are milled from solid, high-grade aluminum stock so there are no welds or seams, for greater strength and durability. Hunting riflescopes feature 30 mm tubes, while the high-magnification tactical riflescopes boast oversized 34 mm tubes that provide greater elevation and windage adjustment at longer ranges.

BUILT FOR ABUSE

Durability is put to the test to ensure all Steiner riflescopes are fully shockproof to withstand endless abuse from high-powered calibers. Scopes are impact tested on all optical and electronic components, and can withstand up to 900 Gs of impact.

LIFETIME HERITAGE WARRANTY

The Steiner Heritage Warranty means we stand behind our products. We will repair or replace your product at no charge to you. It covers all riflescopes and binoculars sold in the US and Canada.



See full warranty details at www.steiner-optics.com/product-warranties

PROPRIETARY LENS COATINGS

The variety of lens coatings, such as Steiner Nano-Protection™, and CAT™ Color Adjustment Transmission, add strength, protection, and clarity to your Steiner riflescope.

CAT Coating



Before



After

PRECISION RETICLES

Steiner offers a wide variety of reticles perfectly suited to your hunting, competitive, or tactical shooting adventures. From clean, simple designs for fast-action target shooting, to detailed, precision reticles for long-range shooting, you'll experience premium accuracy with Steiner reticles.

See all our reticle options on page 32 or download the Steiner Reticle Guide at www.steiner-optics.com/download-catalog.

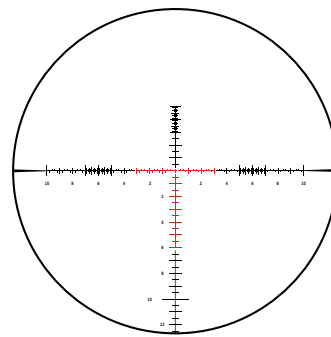

SCR Reticle

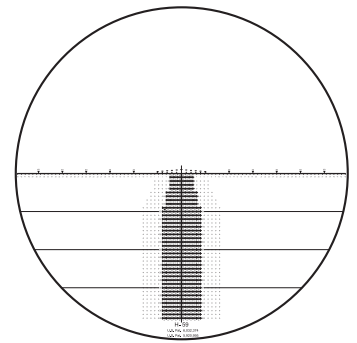

Horus H59 Reticle

WHICH RIFLESCOPE IS RIGHT FOR YOU?

HUNTING		
FEATURE	GS3	H4Xi
Zoom ratio	5x	4x
Game-Sensing CAT coatings	Yes	
Illuminated Reticle		Yes
MSRP Range	\$1,059.99 - \$1,379.99	\$1,299.99 - 1,349.99

TACTICAL			
FEATURE	P-Series	T-Series	M-Series
Zoom ratio	4x	5x	5x/6x/7x/8x
Nano Protection coatings			Yes
Turret Feature	Resettable Zero	Never-Lost	Duo-Scale
Reticle Options	2	5	5
Illuminated Reticle	11 settings	11 settings	11 settings
MSRP Range	\$749.99 - \$1,599.99	\$1,789.99 - \$2,52.99	\$2,999.99 - \$6,439.99

SIGHTS				
FEATURE	DRS1X	Battle Sights	ICS	MRS
Zoom ratio	1x	3x/5x	6x	1x
QD Mounts		Yes	Yes	
Laser Rangefinder / Ballistic Calculator			Yes	
Illuminated Reticle	7 settings	10 settings	4 settings	Auto + Manual
MSRP Range	\$749.99	\$1,229.99 - \$1,289.99	\$4,599	\$539.99

GS3 SERIES



**DEADLIER
VISION
THAN HUMANLY
POSSIBLE.**

GERMAN ENGINEERED,
AMERICAN MADE.

5X VERSATILITY
FOR VIRTUALLY ANY
RIFLE, PLUS CAT™
COLOR ADJUSTED
TRANSMISSION
COATINGS TO PICK
OUT PREY FROM ANY
ENVIRONMENT.

Versatile enough
for big game, prairie
dogs or varmints.



GS3 4-20X50

ITEM NO. 5007 (PLEX S7) UPC 000381850072
ITEM NO. 5008 (PLEX S1) UPC 000381850089

Gives varmint and hog
hunters sharp images at
night and in dim light.



GS3 3-15X56

ITEM NO. 5006 (PLEX S1) UPC 000381850065

For low-light performance
that mounts on most rifles
without extra-high rings.



GS3 3-15X50

ITEM NO. 5005 (PLEX S1) UPC 000381850058

Offers a wide field of
view, making it easier to
find your target.



GS3 2-10X42

ITEM NO. 5004 (PLEX S1) UPC 000381850041

GS3 SERIES OVERALL FEATURES

- 5X ZOOM RANGE
- CAT™ COLOR ADJUSTED TRANSMISSION
- STEINER NANO-PROTECTION®
- FOGPROOF & WATERPROOF
- SHOCKPROOF



Proudly designed,
machined and
assembled in the USA.

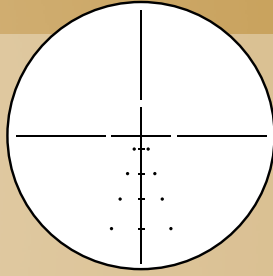

PLEX S1 Reticle

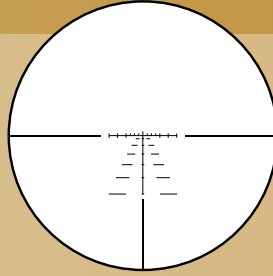

PLEX S7 Reticle



Conventional scope



GS3 scope with
CAT coating

CAT Coating
(simulated comparison)

GS3

	2-10x42	3-15x50	3-15x56	4-20x50
ITEM NUMBER	5004	5005	5006	5007 / 5008
MAGNIFICATION	2-10x	3-15x	3-15x	4-20x
OBJECTIVE LENS DIA.	42 mm	50 mm	56 mm	50 mm
TUBE DIAMETER	30 mm	30 mm	30 mm	30 mm
FOCAL PLANE	2nd	2nd	2nd	2nd
FIELD OF VIEW @ 100 YD. (FT.) LOW/HIGH	52 - 10.5	36 - 7.5	36 - 7.5	25.8 - 5.5
EYE RELIEF (IN.) LOW/HIGH	3.5 - 4.3	3.5 - 4.3	3.5 - 4.3	3.5 - 4.3
EXIT PUPIL (MM)	12 - 4.2	11 - 3.5	11 - 3.5	11 - 2.5
LENGTH (IN.)	13.5	14.1	14.1	14.9
WEIGHT (OZ.)	18	24	25.1	28.2
DIOPTR ADJUSTMENT RANGE	+2 to -3	+2 to -3	+2 to -3	+2 to -3
RETICLE	Plex S1 / 4A	Plex S1 / 4A	Plex S1 / 4A	Plex S7 / Plex S1
ILLUMINATION CONTROL	-	-	-	-
WINDAGE/ELEVATION ADJUSTMENT KNOB	Resettable Zero	Resettable Zero	Resettable Zero	Resettable Zero
WINDAGE/ELEVATION CLICK VALUE	1/4 MOA	1/4 MOA	1/4 MOA	1/4 MOA
WINDAGE RANGE @ 100 M	70 MOA	70 MOA	70 MOA	48 MOA
ELEVATION RANGE @ 100 M	70 MOA	70 MOA	70 MOA	64 MOA
PARALLAX/FOCUS	Fixed	Fixed	Fixed	Side Focus
PARALLAX/FOCUS RANGE	328 ft.	328 ft.	328 ft.	164 ft. to Infinity
RUBBER ARMORING	-	-	-	-
NITROGEN FILLED	Yes	Yes	Yes	Yes
OPERATING TEMPERATURE RANGE	-13° F to +145° F	-13° F to +145° F	-13° F to +145° F	-13° F to +145° F
WATERPROOF/FOGPROOF	Yes	Yes	Yes	Yes
BATTERY	-	-	-	-
WARRANTY	Heritage™ Warranty	Heritage™ Warranty	Heritage™ Warranty	Heritage™ Warranty
MSRP	\$1,059.99	\$1,199.99	\$1,199.99	\$1,379.99

SPECIFICATIONS

The Steiner Heritage Warranty means we stand behind our products. Over half a century of building rugged and reliable product for armed forces around the world gives us this confidence.



We will repair or replace your product at no charge to you. It covers all riflescopes and binoculars sold in the US and Canada for the life of the product.

See full warranty details at www.steineroptics.com/product-warranties

- No warranty card needed.
- No receipt required.
- Warranty is fully transferable to future owners of the product.
- Electronic components are covered by a 3-year warranty.



H4Xi SERIES



**LOW LIGHT
MASTER
FOR ANY
HUNT.**

**HIGH-CONTRAST
OPTICS DELIVER
CLARITY AT DUSK AND
DAWN WITH LIGHT
TRANSMISSION
GREATER THAN 90%.**

A specialist for long-range, high-precision shots even in difficult lighting conditions. Proven performer in challenging hunting situation. Great details at high magnification. Parallax adjustments from 50 m to infinity.



ITEM NO. 5251 UPC 000381852519

H4Xi SERIES OVERALL FEATURES

- HIGH-CONTRAST OPTICS
- WIDER FIELD OF VIEW
- PRECISE ADJUSTMENTS
- LIGHTWEIGHT AND RUGGED
- ILLUMINATED RETICLE

A powerful all-around hunting scope. Lightweight, with a large field of view. High light transmission and precise illumination adjustments delivers perfect performance in any light.



ITEM NO. 5250 UPC 000381852502

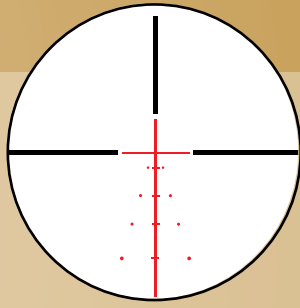

Plex S1 Reticle



Lightweight, Sleek Design

One-piece tubes, hard anodized matte finish. Compact length matches up nicely with any rifle.



Low Profile Turrets

Precision adjustments are standard on all Steiner riflescopes. Side-adjust parallax and reticle illumination are easy to access.

SPECIFICATIONS

H4Xi

	4-16x56	3-12x56
ITEM NUMBER	5251	5250
MAGNIFICATION	4-16x	3-12x
OBJECTIVE LENS DIA.	56 mm	56 mm
TUBE DIAMETER	30 mm	30 mm
FOCAL PLANE	2nd	2nd
FIELD OF VIEW @ 100 YD. (YDS.) LOW/HIGH	13-3	13-3
EYE RELIEF (IN.)	3.8	3.8
EXIT PUPIL (IN.)	.47 to .18	.47 to .18
LENGTH (IN.)	14.5	13.2
WEIGHT (OZ.)	25	25
DIOPTER ADJUSTMENT RANGE	-3 to +2	-3 to +2
RETICLE	Plex S1	Plex S1
WINDAGE/ELEVATION CLICK VALUE	1/4 MOA	1/4 MOA
WINDAGE / ELEVATION RANGE @ 100 M	33 in. - 22 in.	33 in. - 33 in.
PARALLAX FREE	54 yards to infinity	100 yards fixed
NITROGEN FILLED	Yes	Yes
TEMPERATURE RANGE	-13° F to +149° F	-13° F to +149° F
WATERPROOF/FOGPROOF	Yes	Yes
WATERPROOF (FT.)	6.5	6.5
BATTERY	CR2032	CR2032
WARRANTY	Heritage™ Warranty	Heritage™ Warranty
MSRP	\$1,349.99	\$1,299.99

The Steiner Heritage Warranty means we stand behind our products. Over half a century of building rugged and reliable product for armed forces around the world gives us this confidence.

We will repair or replace your product at no charge to you. It covers all riflescopes and binoculars sold in the US and Canada for the life of the product.

See full warranty details at www.steineroptics.com/product-warranties

- No warranty card needed.
- No receipt required.
- Warranty is fully transferable to future owners of the product.
- Electronic components are covered by a 3-year warranty.



Proudly designed, machined and assembled in the USA.



P-SERIES



**GIVE
YOURSELF
THE CLEAR
ADVANTAGE.**

DESIGNED FOR
PATROL AND TACTICAL
OPERATIONS, THE
RUGGED P4XI SCOPES
OFFER CLEAR IMAGES
AND A FAST-ACTION
RETICLE TO TACKLE
EVERY DAY USE OR
SUDDEN ACTION.

Close-combat scope with 30 mm tube, generous field-of-view and new P3TR illuminated reticle for fast target acquisition.



ITEM NO. 5202 UPC 000381852021



OPTIC OF THE YEAR!

The Steiner P4Xi won the NRA's Shooting Illustrated Optic of the Year for 2018. "Lightweight and easy to use, the Steiner P4Xi 1-4x24 scope will be a first-rate choice for patrol rifles and AR platforms. You can't ask much more from a quality piece of tactical shooting glass."

**P4Xi-SERIES
OVERALL FEATURES**

- COMPACT & LIGHTWEIGHT DESIGN
- HIGH CONTRAST OPTICS
- WIDE FIELD OF VIEW
- P3TR ILLUMINATED RETICLE

Medium range scope with 34 mm tube, an illuminated front focal plane Special Competition Reticle (SCR™) and side parallax adjustment.



ITEM NO. 5221 UPC 000382252212

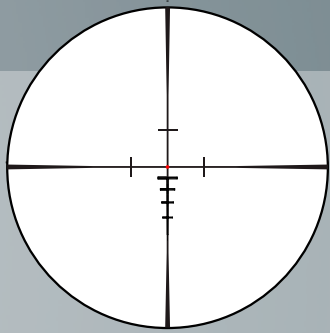

P3TR™ Reticle

The P3TR Reticle:

Designed for tactical rifles and CQB situations. The reticle is calibrated for 5.56 mm and 7.62 mm with stadia allowing you to confidently shoot to 600 yards.

Offers daylight viewable illumination with 11 intensity settings: 4 night, 5 day and 2 night vision levels. Includes an "off" position between all 11 settings



Low-Profile Knobs

Designed for precise windage/elevation adjustment. Calibrated so 1 Click = 1/2 MOA @ 100 yds for the 1-4x.

SPECIFICATIONS

	1-4x24	4-16x56mm
ITEM NUMBER	5202	5221
MAGNIFICATION	1-4x	4-16
OBJECTIVE LENS DIA.	24 mm	56 mm
TUBE DIAMETER	30 mm	34 mm
FOCAL PLANE	Second	First
FIELD OF VIEW AT 100 YD. (FT.) LOW/HIGH	110-27.5	27.5-6.9
EYE RELIEF (IN.) LOW/HIGH	3.5 -4.0	.5-4.0
EXIT PUPIL (MM) LOW/HIGH	12.0 - 6.0	14-3.50
LENGTH (IN.)	10.3	14.6
WEIGHT (W/O CAPS) (OZ.)	17.3	30
DIOPTRER ADJUSTMENT RANGE	+2 to -3	+2 to -3
RETICLE	P3TR™	SCR™
ILLUMINATION CONTROL	Rotary Dial	Rotary Dial
ELEVATION ADJUSTMENT	.5 MOA	.1 mRad
WINDAGE ADJUSTMENT	.5 MOA	1 cm
WINDAGE RANGE @ 100 M	100 MOA	16 MIL
ELEVATION RANGE @ 100 M	100 MOA	30 MIL
PARALLAX/FOCUS	Fixed	Side Focus
PARALLAX/FOCUS RANGE	100 yd.	50 yd. to Infinity
NITROGEN FILLED	Yes	Yes
OPERATING TEMP. RANGE	-13°/ to +145° F	-13°/ to +145° F
LENS CAPS	No	No
WATERPROOF/FOGPROOF	Submersible to 33 Ft	Submersible to 33 Ft
BATTERY	CR2032	CR2032
WARRANTY	Heritage™ Warranty	Heritage™ Warranty
MSRP	\$749.99	\$1,599.99

The Steiner Heritage Warranty means we stand behind our products. Over half a century of building rugged and reliable product for armed forces around the world gives us this confidence.



We will repair or replace your product at no charge to you. It covers all riflescopes and binoculars sold in the US and Canada for the life of the product.

See full warranty details at www.steineroptics.com/product-warranties

- No warranty card needed.
- No receipt required.
- Warranty is fully transferable to future owners of the product.
- Electronic components are covered by a 3-year warranty.



Proudly designed, machined and assembled in the USA.



T-SERIES

**GERMAN
PRECISION.
AMERICAN
PRIDE.**



THE T5XI SERIES OFFERS THE ULTIMATE IN PRECISION, RUGGEDNESS AND VERSATILITY. THREE MODELS TO MASTER EVERYTHING FROM CLOSE-QUARTERS TO LONG-RANGE.

T5Xi 5-25X56



Long-range scope with 34 mm tube, illuminated etched glass, front focal plane SCR reticle, low profile, resettable turrets and locking diopter ring.

ITEM NO. 5122 (SCR) UPC 000381851222
ITEM NO. 5126 (SCR-MOA) UPC 000381851260

**T5Xi-SERIES
OVERALL FEATURES**

- 5X ZOOM RANGE
- LOW-PROFILE NEVER-LOST™ TURRETS
- SECOND ROTATION INDICATOR
- ILLUMINATION - 4 NIGHT / 7 DAY LEVELS
- WATERPROOF/ FOGPROOF/ SHOCKPROOF
- LOCKING DIOPTER

Medium-range scope with 34 mm tube, illuminated etched glass, front focal plane Special Competition Reticle (SCR™), and a Second Rotation Indicator that shows each mil of elevation through the indication window on the elevation turret.

T5Xi 3-15X50



Close-combat scope with 30 mm tube, 3-Gun Tactical Reticle™ calibrated in 5.56 or 7.62, true 1x eyes-open capability for situational awareness and 5x power to engage distant targets.

T5Xi 1-5X24

ITEM NO. 5101 (3TR 5.56) UPC 000381851017



Proudly designed, machined and assembled in the USA.



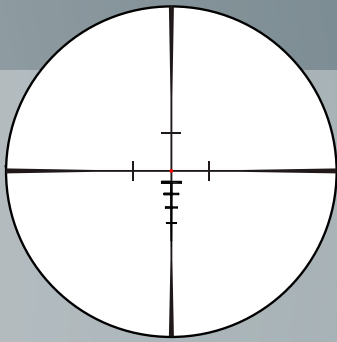

3TR™ Reticle
(5.56 OR 7.62)

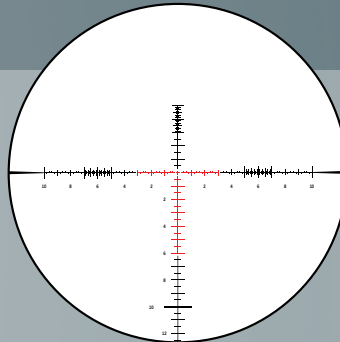

SCR™ / SCR™-MOA Reticle



Consistent Eye Relief

A generous eye box eliminates the need to reposition your eye when changing magnification.

SPECIFICATIONS

	T5Xi				
	1-5x24	3-15x50	3-15x50	5-25x56	5-25x56
ITEM NUMBER	5101	5112	5114	5122	5126
MAGNIFICATION	1-5x	3-15x	3-15x	5-25x	5-25x
OBJECTIVE LENS DIA.	24 mm	50 mm	50 mm	56 mm	56 mm
TUBE DIAMETER	30 mm	34 mm	34 mm	34 mm	34 mm
FOCAL PLANE	2nd	1st	1st	1st	1st
FIELD OF VIEW AT 100 YD. (FT.) LOW/HIGH	108 - 21	36 - 7.3	36 - 7.3	21.5 - 4.3	21.5 - 4.3
EYE RELIEF (IN.) LOW/HIGH	3.5 - 4.3	3.5 - 4.3	3.5 - 4.3	3.5 - 4.3	3.5 - 4.3
EXIT PUPIL (MM) LOW/HIGH	11 - 4.8	12 - 3.4	12 - 3.4	11.2 - 2.3	11.2 - 2.3
LENGTH (IN.)	11.3	13.1	13.1	16.6	16.6
WEIGHT (OZ.)	19.4	29.8	29.8	33	33
DIOPTRER ADJUSTMENT RANGE	+2 to -3	+2 to -3	+2 to -3	+2 to -3	+2 to -3
RETICLE	3TR™ 5.56 / 3TR™ 7.62	SCR™	SCR-MOA	SCR™	SCR-MOA
ILLUMINATION CONTROL	Illuminated Reticle with 4-Night/7-Day Levels	Illuminated Reticle with 4-Night/7-Day Levels	Illuminated Reticle with 4-Night/7-Day Levels	Illuminated Reticle with 4-Night/7-Day Levels	Illuminated Reticle with 4-Night/7-Day Levels
ELEVATION ADJUSTMENT KNOB	Resettable Zero	Resettable Zero	Resettable Zero	Resettable Zero	Resettable Zero
WINDAGE/ELEVATION CLICK VALUE	1 cm (0.1 mrad)	1 cm (0.1 mrad)	1/4 MOA	1 cm (0.1 mrad)	1/4 MOA
WINDAGE RANGE @ 100 M	300 cm (30 mils)	150 cm (15 mils)	54 MOA	150 cm (15 mils)	54 MOA
ELEVATION RANGE @ 100 M	300 cm (30 mils)	340 cm (34 mils)	120 MOA	260 cm (26 mils)	90 MOA
PARALLAX/FOCUS	Fixed	Side Focus	Side Focus	Side Focus	Side Focus
PARALLAX/FOCUS RANGE	100 yd.	25 yd. to Infinity	25 yd. to Infinity	50 yd. to Infinity	50 yd. to Infinity
NITROGEN FILLED	Yes	Yes	Yes	Yes	Yes
OPERATING TEMP. RANGE	-13° F to +145° F	-13° F to +145° F	-13° F to +145° F	-13° F to +145° F	-13° F to +145° F
LENS CAPS	Yes	Yes	Yes	Yes	Yes
WATERPROOF/FOGPROOF	Submersible to 33 ft.	Submersible to 33 ft.	Submersible to 33 ft.	Submersible to 33 ft.	Submersible to 33 ft.
BATTERY	CR2450	CR2450	CR2450	CR2450	CR2450
WARRANTY	Heritage™ Warranty	Heritage™ Warranty	Heritage™ Warranty	Heritage™ Warranty	Heritage™ Warranty
MSRP	\$1,789.99	\$2,299.99	\$2,299.99	\$2,529.99	\$2,529.99

The Steiner Heritage Warranty means we stand behind our products. Over half a century of building rugged and reliable product for armed forces around the world gives us this confidence.



We will repair or replace your product at no charge to you. It covers all riflescopes and binoculars sold in the US and Canada for the life of the product.

- See full warranty details at www.steineroptics.com/product-warranties
- No warranty card needed.
 - No receipt required.
 - Warranty is fully transferable to future owners of the product.
 - Electronic components are covered by a 3-year warranty.

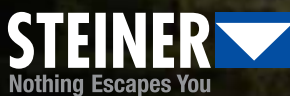

M-SERIES



**BUILT IN
GERMANY.
DESIGNED FOR
THE WORLD.**

THE GERMAN-
MADE M-SERIES
FEATURES WORLD-
CLASS ENGINEERING
AND OPTICAL
SYSTEMS, BUILT TO
STRICT MILITARY
SPECIFICATIONS AND
PRECISELY CRAFTED
FOR VICTORY - ON THE
BATTLEFIELD, OR IN
COMPETITION.

**M5Xi & M6Xi
OVERALL FEATURES**

- MIL-SPEC
- 5X / 6X ZOOM RANGE
- BROADBAND ANTI-REFLECTION COATINGS
- OPTIMIZED EXTERIOR DESIGN
- PRECISE WINDAGE/ELEVATION ADJUSTMENT
- ILLUMINATED RETICLE
- FOGPROOF & WATERPROOF DOWN TO 33 FT.
- SHOCKPROOF



M5Xi 5-25X56

The premier Steiner long-range scope with 34 mm tube, true 25x magnification, etched glass reticle, and DuoScale™ elevation with second-rotation scale that's hidden when inactive.

- ITEM NO. 5525 (G2B MIL-DOT) | BLACK UPC 000381855251
- ITEM NO. 8704-MSR V2 (MSR-V2) | BLACK UPC 840229103751
- ITEM NO. 8704 (HORUS® H59®) | BLACK UPC 840229101580
- ITEM NO. 8704-T3 (HORUS TREMOR® 3) | BLACK UPC 840229101962
- ITEM NO. 8709-G2B (G2B MIL-DOT) | COYOTE BROWN UPC 840229103669
- ITEM NO. 8709-MSR V2 (MSR-V2) | COYOTE BROWN UPC 840229103706
- ITEM NO. 8709-H59 (HORUS® H59®) | COYOTE BROWN UPC 840229103683
- ITEM NO. 8709 (HORUS TREMOR® 3) | COYOTE BROWN UPC 840229101979

Medium-range scope with 34 mm tube, etched glass reticle, and patented DuoScale™ elevation adjustment with a second-rotation scale that's hidden when inactive.



M5Xi 3-15X50

- ITEM NO. 5572 (G2B MIL-DOT) | BLACK UPC 000381855725
- ITEM NO. 8707-MSR V2 (MSR-V2) | BLACK UPC 840229104437
- ITEM NO. 8707-H59 (HORUS® H59®) | BLACK UPC 840229101887
- ITEM NO. 8707-TREMOR III (HORUS TREMOR® 3) | BLACK UPC 840229101900
- ITEM NO. 8713-G2B | COYOTE BROWN UPC 840229103614
- ITEM NO. 8713 (MSR-V2) | COYOTE BROWN UPC 840229104420
- ITEM NO. 8713-H59 (HORUS® H59®) | COYOTE BROWN UPC 840229103638
- ITEM NO. 8713-T3 (HORUS TREMOR® 3) | COYOTE BROWN UPC 840229103652

One of the most versatile in the series, the new 1-6x scope will match perfectly with any tactical or competition rifle, or dangerous game hunting rifle. Available with the Rapid Dot reticle in 5.56 or 7.62.



M6Xi 1-6X24

- ITEM NO. 8708-556 (RAPID DOT 5.56 CCW) | BLACK UPC 840229101009
- ITEM NO. 8712-556 (RAPID DOT 5.56 CCW) | COYOTE BROWN UPC 840229103911

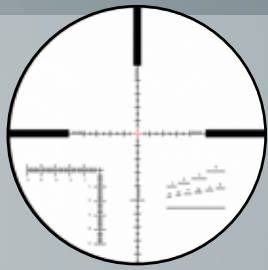

**MSR2
Reticle**

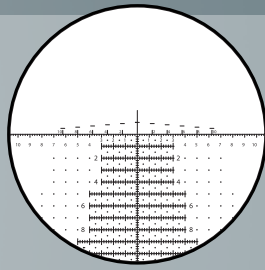

**Horus® H59®
Reticle**

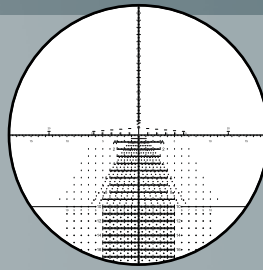

**Horus® TRemOR3
Reticle**

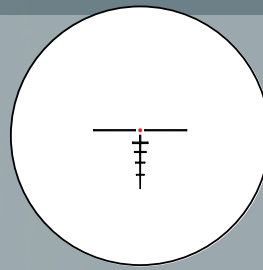

**Rapid Dot
Reticle 5.57**

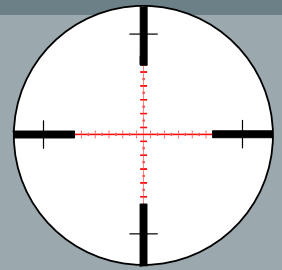

**G2B Mil-Dot
Reticle**

SPECIFICATIONS

	M5Xi				M6Xi
	3-15x50	3-15x50	5-25x56	5-25x56	1-6x24
ITEM NUMBER	5572 / 8707-MSR2 8707-H59 / 8707-T3	8713-G2B / 8713 8713-H59 / 8713-T3	5525 / 8704-MSR2 8704 / 8704-Tremor III	8709-G2B / 8709-MSR2 8709-H59 / 8709	8708-556 / 8712-556
MAGNIFICATION	3-15x	3-15x	5-25x	5-25x	1-6x
COLOR	Black	Coyote Brown	Black	Coyote Brown	Black / Coyote Brown
OBJECTIVE LENS DIA.(MM)	50	50	56	56	24
TUBE DIAMETER	34mm	34mm	34mm	34mm	30mm
FOCAL PLANE	1st	1st	1st	1st	2nd
FIELD OF VIEW AT 100 YD. (FT.) LOW/HIGH	39.7 - 7.9	39.7 - 7.9	23.6 - 4.6	23.6 - 4.6	118 -19.7
EYE RELIEF (IN.) LOW/HIGH	3.5 - 4.3	3.5 - 4.3	3.5 - 4.3	3.5 - 4.3	3.5 - 4.3
EXIT PUPIL (MM) LOW/HIGH	10.4 - 3.3	10.4 - 3.3	9.8 - 2.2	9.8 - 2.2	11.5-4
LENGTH (IN.)	14.2	14.2	16.6	16.6	11.25
WEIGHT (OZ.)	32.5	32.5	36.3	36.3	22
DIOPTR ADJUSTMENT RANGE	+2 to -3	+2 to -3	+2 to -3	+2 to -3	+2 to -3
RETICLE	G2B / MSR2 / H59® Horus Tremor® 3	G2B / MSR2 / H59® Horus Tremor® 3	G2B / MSR2 / H59® Horus Tremor® 3	G2B / MSR2 / H59® Horus Tremor® 3	Rapid Dot 5.56
ILLUMINATION CONTROL	Rotary Digital Control with Intermediate Stops	Rotary Digital Control with Intermediate Stops	Rotary Digital Control with Intermediate Stops	Rotary Digital Control with Intermediate Stops	Rotary Digital Control with Intermediate Stops
ELEVATION ADJUSTMENT KNOB	Duo Scale™ / Resettable Zero	Duo Scale™ / Resettable Zero	Duo Scale™ / Resettable Zero	Duo Scale™ / Resettable Zero	Resettable Zero
WINDAGE/ELEVATION CLICK VALUE	1 cm (0.1 mrad)	1 cm (0.1 mrad)	1 cm (0.1 mrad)	1 cm (0.1 mrad)	1 cm (0.1 mrad)
WINDAGE RANGE @ 100 M	± 60 cm (± 6 mils)	± 60 cm (± 6 mils)	± 60 cm (± 6 mils)	± 60 cm (± 6 mils)	160 cm (16 mils)
ELEVATION RANGE @ 100 M	260 cm (26 mils)	260 cm (26 mils)	260 cm (26 mils)	260 cm (26 mils)	320 cm (32 mils)
PARALLAX/FOCUS	Side Focus	Side Focus	Side Focus	Side Focus	Fixed
PARALLAX/FOCUS RANGE	164 ft. to Infinity	164 ft. to Infinity	164 ft. to Infinity	164 ft. to Infinity	328 ft.
NITROGEN FILLED	Yes	Yes	Yes	Yes	Yes
OPERATING TEMP. RANGE	-13° F to +145° F	-13° F to +145° F	-13° F to +145° F	-13° F to +145° F	-13° F to +145° F
LENS CAPS	Yes	Yes	Yes	Yes	Yes
WATERPROOF/FOGPROOF	Submersible to 33 ft.	Submersible to 33 ft.	Submersible to 33 ft.	Submersible to 33 ft.	Submersible to 33 ft.
BATTERY	CR2450	CR2450	CR2450	CR2450	CR2450
SPECIAL FEATURES	Resettable Turrets, Second Rotation Indicator, Zero Stop	Resettable Turrets, Second Rotation Indicator, Zero Stop	Resettable Turrets, Second Rotation Indicator, Zero Stop	Resettable Turrets, Second Rotation Indicator, Zero Stop	Resettable Turrets, Zero Stop
WARRANTY	Heritage™ Warranty	Heritage™ Warranty	Heritage™ Warranty	Heritage™ Warranty	Heritage™ Warranty
MSRP	\$3,329.99 / \$3,429.99 \$3,794.99 / \$3,599.99	\$3,559.99 / \$3,679.99 \$4,029.99 / \$4,029.99	\$3,549.99 / \$3,599.99 \$4,229.99 / \$4,359.99	\$3,849.99 / \$3,969.99 \$4,489.99 / \$4,89.99	\$2,999.99 / \$3,199.99



The Steiner Heritage Warranty means we stand behind our products. Over half a century of building rugged and reliable product for armed forces around the world gives us this confidence.

We will repair or replace your product at no charge to you. It covers all riflescopes and binoculars sold in the US and Canada for the life of the product.

See full warranty details at www.steineroptics.com/product-warranties

- No warranty card needed.
- No receipt required.
- Warranty is fully transferable to future owners of the product.
- Electronic components are covered by a 3-year warranty.



M-SERIES NEW



**POINT BLANK
IMPACT FOR
LONG RANGE
TARGETS.**

SHORTER,
LIGHTER, HIGHER-
POWERED AND
MORE VERSATILE,
THESE NEW SCOPES
TAKE LONG-RANGE
PRECISION TO A
WHOLE NEW LEVEL.
YOUR TARGET IS
SHARP, CLEAR AND
AS GOOD AS DRILLED,
NO MATTER WHEN
OR WHERE.

4-28X56 M7Xi 4-28X56



The 7x zoom gives the operator more flexibility and higher resolution for all distances

ITEM NO. 8719-G2B | G2B MIL-DOT UPC 840229104192

ITEM NO. 8719-MSR2 | MSR2 UPC 840229104222

ITEM NO. 8719-T3 | TREMOR 3 UPC 840229104215

ITEM NO. 8720-MSR2 | MSR2 - COYOTE BROWN UPC 840229104321

ITEM NO. 8720-T3 | TREMOR 3 - COYOTE BROWN UPC 840229104314

M7Xi & M8Xi OVERALL FEATURES

- NEW 7X / 8X ZOOM RANGES
- LOW PROFILE TURRETS
- SHORTER OVERALL LENGTH
- EXTENDED RANGE AND GREATER FIELD-OF-VIEW

1-8X24 M8Xi 1-8X24



Building on the success of the M5Xi 1-5, the new M8Xi 1-8x24 has a shorter overall length leaving more rail space for mounting laser aiming, thermal imaging or night vision devices.

ITEM NO. 8723 UPC 840229104390



Optimized Tube/Knob Design

Provides more mounting options on different rifles or added equipment.



Waterproof/Fogproof

Durable construction you can trust to stand up to any conditions. Waterproof to depths of 33 feet.



Precise Adjustment

Insure repeated accuracy, with tactile, click-by-click feedback you can hear and feel.

SPECIFICATIONS

	M7Xi 4-28x56	M7Xi 4-28x56	M8Xi 1-8x24
ITEM NUMBER	8719-G2B 8719-MSR2 8719-T3	8720-MSR2 8720-T3	8723
MAGNIFICATION	4-28x	4-28x	1-8x
OBJECTIVE LENS DIA.(MM)	56 (2.2 in)	56 (2.2 in)	24 (0.94 in)
TUBE DIAMETER (MM)	34	34	34
EYE RELIEF (IN)	3.54 (90 mm)	3.54 (90 mm)	3.54 (90 mm)
FIELD OF VIEW AT 100 M	9 - 1.42 m	9 - 1.42 m	32 - 4.5m
DIOPTRER ADJUSTMENT	-2 to +2	-2 to +2	-2 to +2
PARALLAX ADJUSTMENT	50m at the low end	50m at the low end	Side Focus
COLOR	Black	Coyote Brown	Black
LENGTH (IN.)	15.2	15.2	10.8
WEIGHT (OZ.)	33.5	33.5	26.5
OPERATING TEMPERATURE	-40-+160°F	-40-+160°F	-40-+160°F
RETICLE OPTIONS	G2B Mil Dot / MSR2 / TReMoR 3	MSR2 / TReMoR 3	DMR8i
ELEVATION RANGE @ 100 M	260 cm / 26 mils	260 cm / 26 mils	260 cm / 26 mils
WINDAGE RANGE @ 100 M	60 cm	60 cm	60 cm
WINDAGE ELEVATION CLICK VALUE	1 cm (0.1 mrad)	1 cm (0.1 mrad)	1 cm (0.1 mrad)
BATTERY	CR2032	CR2032	CR2032
WARRANTY	Heritage™ Warranty	Heritage™ Warranty	Heritage™ Warranty
MSRP PRICE	\$3,559.99 / \$3,679.99 / \$4,249.99	\$3,899.99 / \$4,484.99	\$3,199.99

The Steiner Heritage Warranty means we stand behind our products. Over half a century of building rugged and reliable product for armed forces around the world gives us this confidence.



We will repair or replace your product at no charge to you. It covers all riflescopes and binoculars sold in the US and Canada.

See full warranty details at www.steiner-optics.com/product-warranties

- No warranty card needed.
- No receipt required.
- Warranty is fully transferable to future owners of the product.

M-SERIES IFS NEW

INTELLIGENT FIRING SOLUTION WITH HEADS UP DISPLAY.



NO ACCURACY-KILLING DISTRACTION. JUST RAZOR-SHARP, SMART-TECH FOCUS ON ALL THAT MATTERS: THIS. ONE. SHOT.

4-28X56 M7Xi IFS 4-28X56



Intelligent Firing Solution with integrated customizable display provides all the important information in real time to the operator.

ITEM NO. 8719-G2B_E | G2B RETICLE UPC 840229104239
 ITEM NO. 8719-MSR 2_E | MSR 2 RETICLE UPC 840229104260
 ITEM NO. 8719-T3_E | TREMOR 3 RETICLE UPC 840229104253

M-SERIES IFS OVERALL FEATURES

- BUILT-IN BALLISTIC CALCULATOR AND SENSOR SUITE
- HEADS UP DISPLAY OF FIRING SOLUTION
- DISPLAY AND USER INTERFACE
- BLUETOOTH CONNECTIVITY
- PRECISE WINDAGE/ELEVATION ADJUSTMENT
- OPTIMIZED TUBE AND KNOB CONFIGURATION
- WATERPROOF / FOGPROOF / SHOCKPROOF
- CUSTOM APP FOR PROGRAMING SIGHT AND DISPLAY

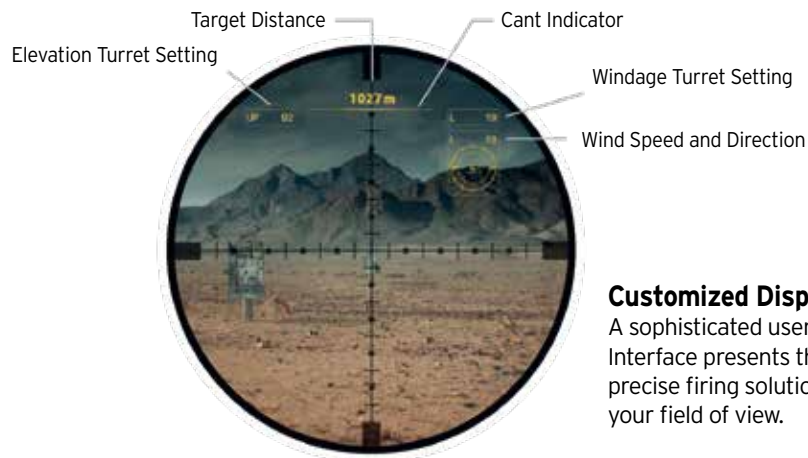

Customized Display
 A sophisticated user Interface presents the precise firing solution in your field of view.



Sensor Suite

Menu Key Panel and sensors provide real-time input for temperature barometric air pressure and inclination



Bluetooth Connectivity

Smart phones and other devices make it easy to set up and use the IFS.



Optimized Tube/Knob Design

Provides more mounting options on different rifles or added equipment.

SPECIFICATIONS

M7Xi IFS 4-28x56

ITEM NUMBER	8719-G2B_e/ 8719-MSR2_e/ 8719-T3_e
MAGNIFICATION	4-28x
OBJECTIVE LENS DIA.(MM)	56 (2.2 in.)
TUBE DIAMETER	34 mm
EYE RELIEF (IN.)	3.54
FIELD OF VIEW AT 100 M	9 - 1.42m
DIOPTER ADJUSTMENT	-2 to +2
PARALLAX ADJUSTMENT	Side Focus
LENGTH (IN.)	15.4
WEIGHT (OZ.)	40.6
OPERATING TEMPERATURE	according to MIL STD 810G
RETICLE	G2B /MSR2 /TReMoR 3
ELEVATION RANGE @ 100M	260 cm / 26 mils
WINDAGE RANGE @ 100M	± 60cm / 6 mils
WIND/ELEVATION CLICK VALUE	1 cm (0.1 mrad)
IMMERSION	20 m (66 ft.)
NITROGEN FILLED	Yes
BATTERY	1 x AA /CR2032
WARRANTY	Heritage™ Warranty
MSRP	\$5,749.99 / \$5,865.99 \$6,439.99

The Steiner Heritage Warranty means we stand behind our products. Over half a century of building rugged and reliable product for armed forces around the world gives us this confidence.

We will repair or replace your product at no charge to you. It covers all riflescopes and binoculars sold in the US and Canada for the life of the product.

See full warranty details at www.steineroptics.com/product-warranties

- No warranty card needed.
- No receipt required.
- Warranty is fully transferable to future owners of the product.
- Electronic components are covered by a 3-year warranty.

HERITAGE



WARRANTY
GENERATION
TO GENERATION

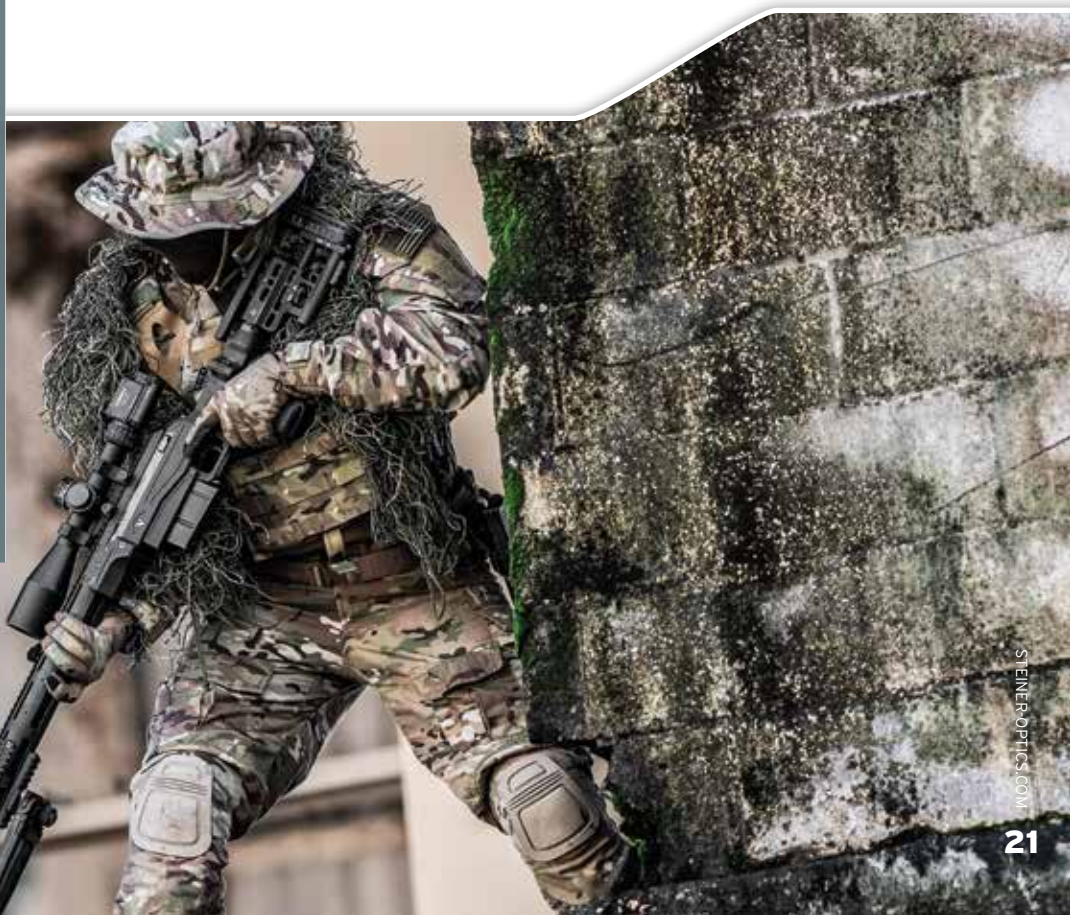

DRS1X NEW



**ENGINEERED
FOR SPEED
SIMPLICITY AND
ACCURACY.**

THE NEW DRS1X LIVES UP TO ITS NAMESAKE WITH RAPID AND LETHAL TARGET ENGAGEMENT AT CLOSE QUARTERS



DRS1X

The ultimate CQB sight, it is built with legendary Steiner's legendary ruggedness. Lightweight, compact and simple to use.

HEIGHT 10.40 IN. | LENGTH 3.88 IN. | WEIGHT 10.40 OZ.
ITEM NO. 8503 UPC 000381852502

DRS1X OVERALL FEATURES

- RUGGED MAGNESIUM BODY
- CHOOSE FROM 3 RETICLE OPTIONS
- SEVEN ILLUMINATION LEVELS (4 DAY/3 NIGHT)
- ADJUSTABLE FOR WINDAGE/ELEVATION
- WATERPROOF/FOGPROOF/SHOCKPROOF
- POWERED BY TWO (2) AA BATTERIES, BUT CAN OPERATE ON ONE
- 2000+ HOURS OF BATTERY RUN TIME
- 13-HOUR AUTO SHUTOFF
- CO-WITNESS WITH IRON SITES OR USE WITH ANY MULTIPLIER

The **Defendu Reflex Sight** is so versatile and effective at close range, we've named it after the famed Lt. Colonel William Ewart Fairbairn, whose Close Quarters Combat system was designed to rapidly disable an opponent with potentially lethal force.

Perfect for tactical operations or home defense, the 1x reflex sight offers three reticles calibrated for speed and accuracy at 7, 25 and 50 yards.

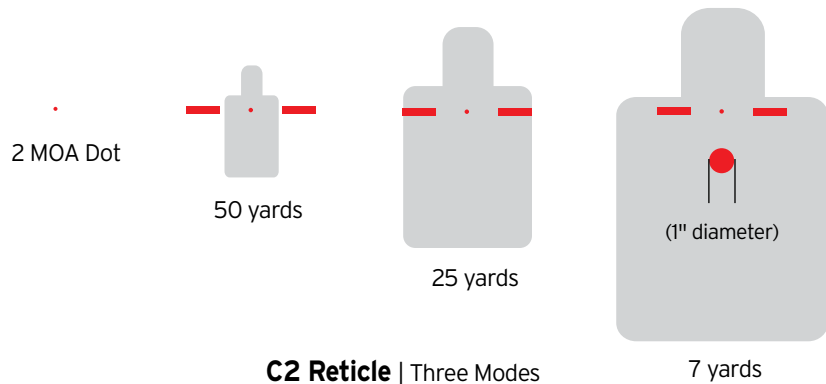



2,000+ Hours of Run Time
 Powered with two AA batteries, this sight is stingy when it comes to power. Auto shut-off after 13 hrs.



Picatinny Rail Mount
 Mounting height allows co-witness of iron sights.



Rugged Magnesium Body
 Provides added durability under the most challenging circumstances.

SPECIFICATIONS

	DRS1X
ITEM NUMBER	8503
WINDOW SIZE (H/W IN.)	.96 / 1.26
LENGTH (IN.)	3.88
WEIGHT (OZ.)	10.40
HEIGHT (IN.)	2.57 Overall 2.35 Above Rail
RETICLE	1. Single Dot 2. Dot and Stadia 3. Dot, Stadia & Close Dot
ILLUMINATION	7 Levels - 4 day (7,6,5,4) - 3 night (3,2,1)
ILLUMINATION	Auto Brightness Control + Manual
WINDAGE/ELEVATION CLICK VALUE	1/2 MOA
TOTAL WINDAGE RANGE	50 MOA
TOTAL ELEVATION RANGE	50 MOA
OPERATING TEMPERATURE	-22°F to 150° F
WATERPROOF DEPTH	5 meters
WATERPROOF & FOG PROOF	YES
BATTERY LIFE	~2800 hours Dot Only
BATTERY	2x AA Batteries
WARRANTY	Heritage Warranty
MSRP PRICE	\$749.99

The Steiner Heritage Warranty means we stand behind our products. Over half a century of building rugged and reliable product for armed forces around the world gives us this confidence.



We will repair or replace your product at no charge to you. It covers all riflescopes and binoculars sold in the US and Canada for the life of the product.

See full warranty details at www.steineroptics.com/product-warranties

- No warranty card needed.
- No receipt required.
- Warranty is fully transferable to future owners of the product.
- Electronic components are covered by a 3-year warranty.



Proudly designed, machined and assembled in the USA.

STEINER 
 Nothing Escapes You



S-SERIES SIGHTS

NEW



**SHORTER,
QUICKER
AND MISSES
NOTHING.**

THIS NEXT-GEN PRISM BATTLE SIGHT HAS IT ALL: WIDER FIELD OF VIEW, LARGER EYE BOX AND EYE RELIEF FOR FASTER ACQUISITION AND SIMPLE OPERATION WITH UNMATCHED OPTICS AND ACCURACY.

The perfect combination of optical quality, field-of-view, eye relief and a large eye box.

OBJECTIVE LENS 32 MM | MAGNIFICATION 4X
LENGTH 5.7 IN. | WEIGHT 25 OZ.
BATTERY CR2032 / 3V
ITEM NO. 8794 UPC 840229104451

4X32
S432 SIGHT



S-SERIES SIGHTS OVERALL FEATURES

- 3X OR 4X MAGNIFICATION
- ROTARY DIGITAL CONTROL ILLUMINATION
- LARGE FIELD OF VIEW
- LARGE EYE RELIEF
- LARGE EYE BOX
- DIOPTRER SETTING FROM -3 TO +3
- 100% FOG PROOF
- WATERPROOF / SHOCKPROOF

The S-Series is designed to never fail. It is waterproof to 10 meters (33ft.), 100% fog-proof (nitrogen filled) and can withstand up to 900 Gs.

OBJECTIVE LENS 32 MM | MAGNIFICATION 3X
LENGTH 5.7 IN. | WEIGHT 21.6 OZ.
BATTERY CR2032 / 3V
ITEM NO. 8793 UPC 840229104444

3X32
S332 SIGHT



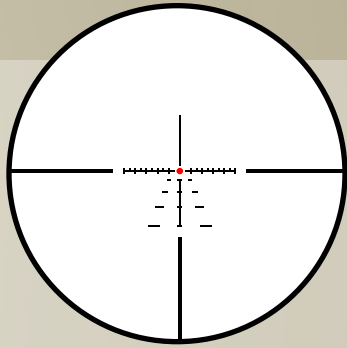

P7TR Reticle



Waterproof Construction
Submersible to 10 meters (33 ft.)



Find Targets Quickly
With its larger field of view, extended eye relief and generous eye box, target are easy to find and engage.

SPECIFICATIONS

	S432 4x32	S332 3x32
ITEM NUMBER	8794	8793
MAGNIFICATION	4x	3x
OBJECTIVE LENS	32 mm	32 mm
EXIT PUPIL (MM)	>7 mm	9.5 mm
EYE RELIEF (IN.)	3.15	3.15
LENGTH (IN.)	5.7	5.7
WEIGHT (G / OZ.)	710 / 25	614 / 21.6
FIELD OF VIEW @ 100M	11.8 m (12.9 y)	14.1 m (15.4 y)
RESOLUTION	< 7 in.	< 7 in.
DIOPTER SETTING	-3 to +3 diopters	-3 to +3 diopters
RETICLE	P7TR Reticle	P7TR Reticle
PARALAX (FOCUS) ADJUSTMENT	Fixed at 100 m (328 ft.)	Fixed at 100 m (328 ft.)
WINDAGE/ELEVATION ADJUSTMENT	± 175 cm @ 100 m	± 175 cm @ 100 m
ADJUSTMENT INCREMENT	1/10 mRad @ 100 m	1/10 mRad @ 100 m
OPERATING TEMPERATURE	-30°C TO +60°C (-22°F TO +140°F)	-30°C TO +60°C (-22°F TO +140°F)
BATTERY	CR2032 / 3V	CR2032 / 3V
MRSP	\$1,289.99	\$1,229.99

The Steiner Heritage Warranty means we stand behind our products. Over half a century of building rugged and reliable product for armed forces around the world gives us this confidence.



We will repair or replace your product at no charge to you. It covers all riflescopes and binoculars sold in the US and Canada for the life of the product.

See full warranty details at www.steineroptics.com/product-warranties

- No warranty card needed.
- No receipt required.
- Warranty is fully transferable to future owners of the product.
- Electronic components are covered by a 3-year warranty.

STEINER 
Nothing Escapes You



INTELLIGENT COMBAT SIGHT



ONE ROUND.
ONE HIT.
NEXT TARGET.

FIRST-SHOT
CONFIDENCE IN
COMBAT-READY FORM:
DISTANCE TO TARGET
AND OPTIMUM AIMING
POINT, INSTANTLY
COMPUTED OUT TO
800 METERS, WITH THE
PUSH OF A BUTTON.
SMART, SIMPLE,
AND DEVASTATING
ACCURACY FOR
INFANTRY AND
TACTICAL OPS.



ICS INTELLIGENT COMBAT SIGHT 6X40

The ICS Intelligent Combat Sight integrates a laser rangefinder and a ballistic calculator into a rugged, compact tactical weapons sight for increased accuracy, greater first-round hit probability, and shorter time of engagement.

INTELLIGENT COMBAT SIGHT OVERALL FEATURES

- ONBOARD COMPUTER FOR AMMUNITION-SPECIFIC TARGETING
- ILLUMINATED RETICLE WITH BRIGHT RED AIMING DOT
- BUILT-IN INCLINOMETER COMPENSATES FOR STEEP ANGLES
- FULLY ADJUSTABLE WINDAGE & ELEVATION
- SHOCKPROOF & WATERPROOF DOWN TO 10 METERS

ITEM NO. 8790 UPC 840229101474



Backup Iron Sights

Fixed iron sights located on the right-hand side of the ICS at a 15° angle, providing a backup sighting option.



Quick Detach HT Mount

Easy-to-use quick detach mount allows for fast removal and mounting on multiple platforms.



Picatinny Rail Top

Allows you to mount a 1x optic on top of the ICS using the Picatinny rail for even greater versatility.

SPECIFICATIONS

	ICS
ITEM NUMBER	8790
MAGNIFICATION	6x
OBJECTIVE LENS DIAMETER	40 mm
FIELD OF VIEW @ 100 YD. (FT.) LOW/HIGH	348
EYE RELIEF (IN.) LOW/HIGH	28.7 - 31.5
EXIT PUPIL (MM)	5.7
LENGTH (IN.)	7.86
WEIGHT (OZ.)	27.9
RETICLE	38 Dot OLED
ILLUMINATION CONTROL	4 Steps (Dimmable)
WINDAGE/ELEVATION CLICK VALUE	1/2 MOA
WINDAGE RANGE @ 100 M	± 50 MOA
ELEVATION RANGE @ 100 M	± 50 MOA
PARALLAX/FOCUS	Fixed at 100 m (328 ft.)
OPERATING TEMPERATURE RANGE	-13° F to +149° F
WATERPROOF/FOGPROOF	Submersible to 33 ft.
BATTERY	CR123A
NITROGEN FILLED	Yes
MOUNT	MIL-STD 1913
WARRANTY	Heritage™ Warranty
MSRP	\$4,599.99

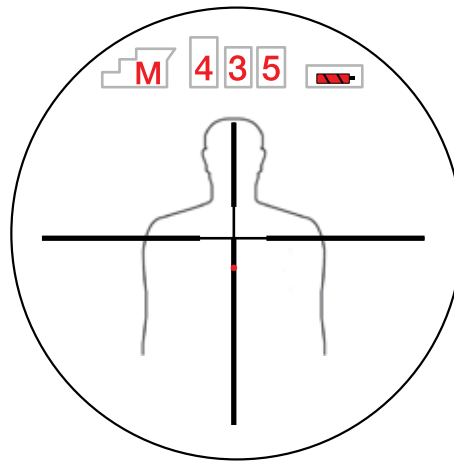

At the push of a button, an eye-safe laser instantly provides distance to the target and an illuminated, trajectory-compensated aiming point based on ammunition ballistics, measured distance, and angle to your target out to 800 meters. As a true electro-optical aiming device, it combines combat-optimized technology, operating simplicity in the field, and the targeting effectiveness to give small-caliber weapons oversized clout.

- Sophisticated targeting technology is rugged, intuitive, and easy to use.
- Easy setup for the 7.62x51mm and other military cartridges.
- Red dot indicates precise point of aim for your specific cartridge and distance.
- Powered by one CR123A battery.

STEINER 
Nothing Escapes You

MRS MICRO REFLEX SIGHT



**EYES OPEN
CONTROL FOR
FAST TARGET
ACQUISITION.**

MRS MICRO REFLEX SIGHT

Holographic 3 MOA red dot sight for close-distance situations. With both eyes open, situational awareness is improved and shooting is dot-on-target accurate with either hand.

THE LOW-PROFILE
MRS IS WELL-
BALANCED ON ANY
SHOOTING PLATFORM,
GIVING SHOOTERS
THE QUICKNESS,
CONFIDENCE, AND
ACCURACY TO CONTROL
THE OUTCOME.

WEIGHT 2.47 OZ. | LENGTH 1.89 IN.
WIDTH 1.81 IN. | HEIGHT 1.57 IN. | BATTERY CR1632
ITEM NO. 8700 UPC 840229101627

The 1x holographic **MRS Micro Reflex Sight** lets operators engage targets with both eyes open, for wider peripheral vision, greater situational awareness, and faster response—critical when engaging moving targets. The 3 MOA red dot is easy to find and quick to aim, ensures either-hand shooting accuracy, and won't obscure targets at longer distances. At only 2.5 oz., the low-profile MRS is well-balanced on any shooting platform, giving shooters the quickness, confidence, and accuracy to control the outcome.

MRS OVERALL FEATURES

- 1X MAGNIFICATION FOR BOTH-EYES-OPEN CAPABILITY.
- ACCURACY WITH EITHER HAND REGARDLESS OF EYE DOMINANCE.
- FULLY ADJUSTABLE WITH 1 MOA CLICK ADJUSTMENT.
- AUTOMATIC OR MANUAL BRIGHTNESS CONTROLS FOR DAY/NIGHT OPERATIONS
- ONE CR1632 BATTERY PROVIDES 550 HOURS OF OPERATION.

SPECIFICATIONS

	MRS
ITEM NUMBER	8700
MAGNIFICATION	1x
WINDOW SIZE (H/W IN.)	-
LENGTH (IN.)	1.89
WEIGHT (OZ.)	2.5
HEIGHT (IN.)	
RETICLE	3 MOA Dot
ILLUMINATION	Auto Brightness Control + Manual
WINDAGE/ELEVATION CLICK VALUE	1 MOA
TOTAL WINDAGE RANGE	90 MOA
TOTAL ELEVATION RANGE	90 MOA
OPERATING TEMPERATURE	13°F to +131°F
WATERPROOF/FOGPROOF	Submersible to 33 ft.
BATTERY	CR 1632
SPECIAL FEATURES	
WARRANTY	Heritage Warranty
MSRP	\$539.99

T-SERIES AR MOUNT

YOUR
PERFECT
MOUNTING
SOLUTION.



T-Series AR Mount

THE STEINER T-SERIES CANTILEVER MOUNT OFFERS THE PERFECT MOUNTING SOLUTION FOR AR-15 AND FLATTOP PLATFORMS. MACHINED FROM RUGGED ALUMINUM ALLOY TO BE INCREDIBLY STRONG, YET LIGHTWEIGHT.

This cantilevered mount combines ruggedness, lightness, and adaptability to be the perfect addition to your platform



ITEM NO. 5970 (30mm diameter, 35mm height)

UPC 000381859709

ITEM NO. 5971 (30mm diameter, 40mm height)

UPC 000381859716

ITEM NO. 5972 (34mm diameter, 40mm height, 25 MOA cant)

UPC 000381859723

T-SERIES AR MOUNT OVERALL FEATURES

- DESIGNED TO FIT 30MM SCOPES
- AVAILABLE IN TWO HEIGHTS: 35MM AND 40MM
- MOUNTS TO ANY PICATINNY-STYLE RAIL
- DESIGNED TO OFFER PERFECT EYE-RELIEF ON MODERN AR-PATTERN RIFLES
- BUBBLE LEVEL ON THE REAR RING FOR MAXIMUM ACCURACY AND CONSISTENCY



Proudly designed, machined and assembled in the USA.

SPECIFICATIONS

T-Series AR Mount

	5970	5971	5972
SIZE	30mm	30mm	34mm
ACTUAL HEIGHT	1.3"	1.6"	1.6"
WEIGHT	6.05 oz.	6.5 oz.	6.4 oz.
MSRP	\$349.99	\$349.99	\$349.99

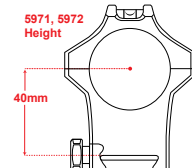
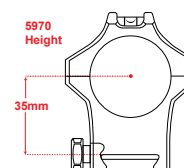

RINGS

**ONLY RINGS
WORTHY
OF THE
STEINER
NAME.**



**STEINER RINGS ARE
THE FOUNDATION
OF A PRECISION
SHOOTING SYSTEM.
DESIGNED AND
ENGINEERED TO
GUARANTEE
PRECISE OPTICAL
ALIGNMENT AND
SHOT-AFTER-SHOT
ACCURACY.**

.....

**STEINER RINGS
OVERALL FEATURES**

- **EASILY MOUNTS TO ANY PICATINNY STYLE RAIL**
- **DESIGNED FOR 30MM SCOPES**
- **AVAILABLE IN LOW, MEDIUM AND EXTRA HIGH**

T-Series Rings

Steiner T-Series Rings offer the perfect riflescope mounting solution for precision shooting.



- ITEM NO. 5960 - 30MM LOW UPC 000381859600
- ITEM NO. 5961 - 30MM MEDIUM UPC 000381859617
- ITEM NO. 5962 - 30MM HIGH UPC 000381859624
- ITEM NO. 5963 - 30MM EXTRA HIGH UPC 000381859631
- ITEM NO. 5964 - 34MM LOW UPC 000381859648
- ITEM NO. 5965 - 34MM MEDIUM UPC 000381859655
- ITEM NO. 5966 - 34MM HIGH UPC 000381859662
- ITEM NO. 5967 - 34MM EXTRA HIGH UPC 000381859679

H-Series Rings

The new H-Series Rings have a sleek design and rugged, lightweight construction. Perfect for your favorite hunting rifle.



- ITEM NO. 5957 - 30MM LOW UPC 000381859570
- ITEM NO. 5958 - 30MM MEDIUM UPC 000381859587
- ITEM NO. 5959 - 30MM HIGH UPC 000381859594



Easy to Mount
Fits any Picatinny-style rail.



Eliminates Scope Cant
An integrated bubble level on the rear right eliminates scope cant.



Adapts to Any Platform
Available in 30 mm and 34 mm sizes in medium, high and extra-high heights.

SPECIFICATIONS

	T-Series Rings								H-Series Rings		
	5960	5961	5962	5963	5964	5965	5966	5967	5957	5958	5959
SIZE	30 mm	30 mm	30 mm	30 mm	34 mm	34 mm	34 mm	34 mm	30 mm	30 mm	30 mm
HEIGHT	Low	Medium	High	Extra High	Low	Medium	High	Extra High	Low	Medium	High
ACTUAL HEIGHT	.885"	1.0"	1.25"	1.35"	.885"	1.0"	1.25"	1.35"	.85"	1.0"	1.35"
WEIGHT	4.1 oz.	4.3 oz.	5.1 oz.	5.4 oz.	3.8 oz.	4.2 oz.	4.9 oz.	5.2 oz.	2.3 oz.	2.6 oz.	3.3 oz.
MSRP	\$229.99	\$229.99	\$229.99	\$229.99	\$229.99	\$229.99	\$229.99	\$229.99	\$91.99	\$91.99	\$91.99

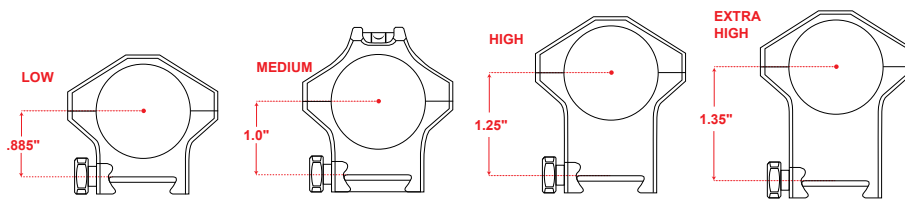

 Proudly designed, machined and assembled in the USA.

STEINER 
Nothing Escapes You



RETICLE SPECIFICATIONS

Steiner is one of the largest manufacturers of high-quality optics in the world. Steiner riflescopes are German engineered and made for hunters and precision shooters who demand the best. These scopes are optically and mechanically superior to scopes that cost thousands more.

We offer a variety of reticle designs for both hunting and precision shooting. This guide explains the reticles that we offer, how to best use them for more precise aiming, and how to adjust for holdover at long distances and hold-off for wind.

P7TR

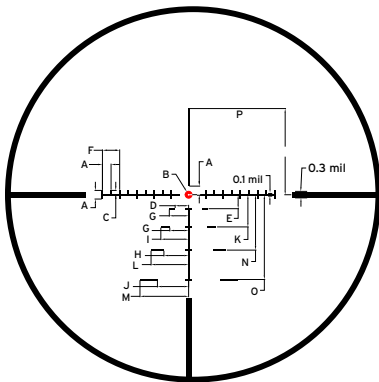

UNIT	mils	UNIT	mils
A	0.5	I	1.6
B	0.4	J	1.8
C	0.25	K	1.87
D	0.8	L	2.2
E	0.81	M	2.8
F	1.0	N	3.21
G	1.1	O	4.95
H	1.4	P	5.0

PLEX S7 RETICLE

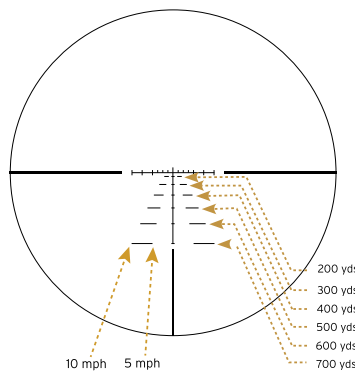

ZERO @ 100 YARDS	Hornady .223 55 gr V-MAX	Hornady .22-250 50 gr V-MAX	Federal 7 mm Mag 175 gr Power-Shok
CROSSHAIR	100	100	100
1ST STADIA	170	200	150
2ND STADIA	250	300	230
3RD STADIA	330	400	300
4TH STADIA	420	500	400
5TH STADIA	500	600	500
6TH STADIA	600	700	600

PLEX S1 RETICLE

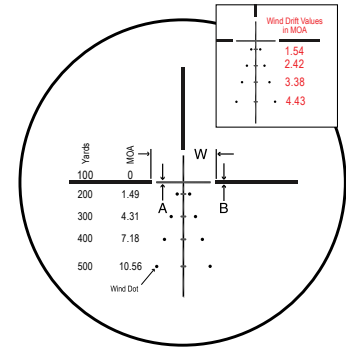

LOW MAG

MODEL	A	B	W	Wind Dot
2-10x	1.55	3.45	38.2	2.15
3-15x	1.05	2.35	38.2	1.45
4-20x	.75	1.45	38.2	1.1

HIGH MAG

MODEL	A	B	W	Wind Dot
2-10x	.31	.69	7.64	.43
3-15x	.21	.47	7.64	.29
4-20x	.15	.29	7.64	.22

G28 MIL DOT RETICLE SUBTENSION

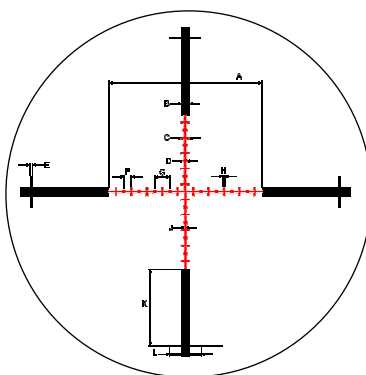

UNIT	mRad	cm/100m	in/100yd
A	10	100	36
B	0.5	5.0	1.8
C	0.5	5.0	1.8
D	0.2	2.0	0.72
E	0.06	0.6	0.22
F	0.5	5.0	1.8
G	1.0	10	3.6
H	0.06	0.6	0.22
J	0.06	0.6	0.22
K	5.0	50	1.8
L	2.0	20	7.2

3TR/P3TR RETICLE SUBTENSION

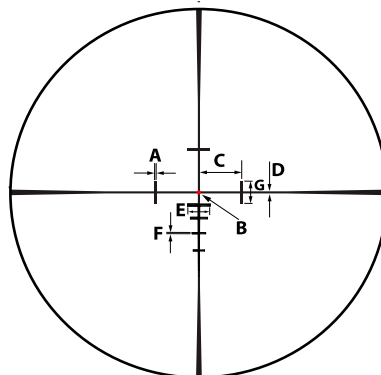

UNIT	mRad	cm/100m	in/100 yd
A	0.15	1.5	0.54
B	0.21	2.1	0.76
C	5.000	50	18.00
D	0.21	2.1	0.76
G	1.00	10	3.60

E .5 m @ Indicated Distance
 F 5 cm @ Indicated Distance
 *200-Yard Zero
 *5.56mm NATO 62 gr SS109 @ 3,100 fps
 *7.62mm NATO 175 gr M118LR @ 2,580 fps

RAPID DOT 5.56, 7.62 RETICLE SUBTENSION

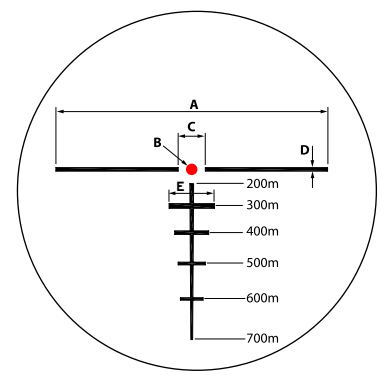

UNIT	mRad	cm/100m	in/100yd
A	10	100	36
B	0.32	3.2	1.15
C	1.0	10	3.6
D	0.13	1.3	0.47

E .5 m @ Indicated Distance
 *100-Yard Zero
 *5.56mm NATO 62 gr SS109 @ 3,100 fps
 *7.62mm NATO 150 gr FMJ @ 2,750 fps

HORUS H59 RETICLE

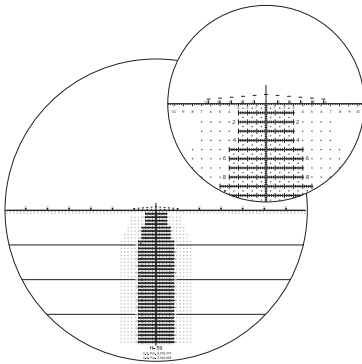

HORUS TREMOR 2 RETICLE

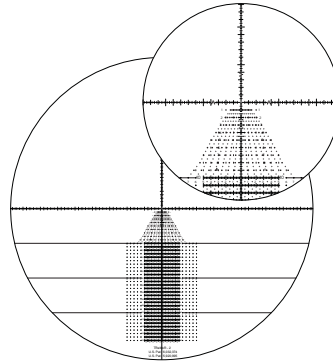

HORUS TREMOR 3 RETICLE

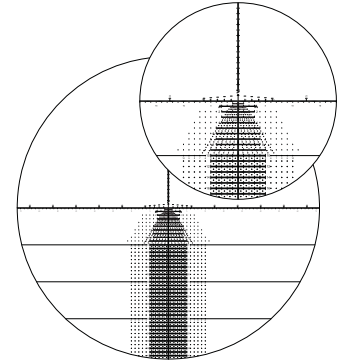

SCR RETICLE SUBTENSION

UNIT	5x-25x Mils	cm	in. @ 100 Y	MOA
A	1.00	10	3.60	3.44
B	0.50	5	1.80	1.72
C	0.035	0.35	0.13	0.12
D	0.10	1	0.36	0.34
E	0.25	2.5	0.90	0.86
F	0.10	1	0.36	0.34
G	0.08	0.8	0.29	0.28
H	2.00	20	7.20	6.88
I	0.20	2	0.72	0.69
J	0.40	4	1.44	1.38
K	0.60	6	2.16	2.06
L	0.80	8	2.88	2.75
M	0.02	0.2	0.07	0.07
N	0.03	0.3	0.11	0.10
O	0.125	1.250	0.45	0.43

UNIT	3x-15x Mils	cm	in. @ 100 Y	MOA
A	1.00	10	3.60	3.44
B	0.50	5	1.80	1.72
C	0.05	0.35	0.18	0.17
D	0.10	1	0.36	0.34
E	0.25	2.5	0.90	0.86
F	0.13	1	0.45	0.43
G	0.08	0.8	0.29	0.28
H	2.00	20	7.20	6.88
I	0.20	2	0.72	0.69
J	0.40	4	1.44	1.38
K	0.60	6	2.16	2.06
L	0.80	8	2.88	2.75
M	0.04	0.2	0.14	0.14
N	0.04	0.3	0.14	0.14
O	0.125	1.250	0.45	0.43

MSR 2 RETICLE SUBTENSION

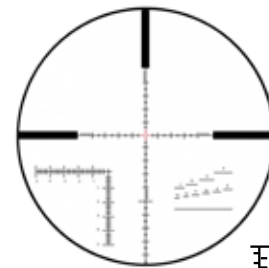

UNIT	Mils
A	0.1
B	0.2
C	0.40
D	0.5
E	1.0

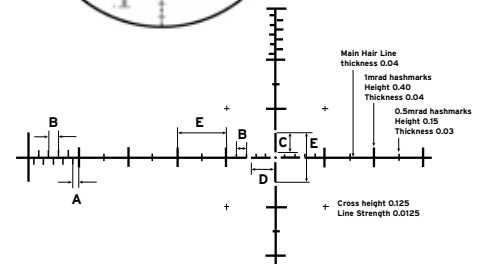

SCR MOA RETICLE SUBTENSION

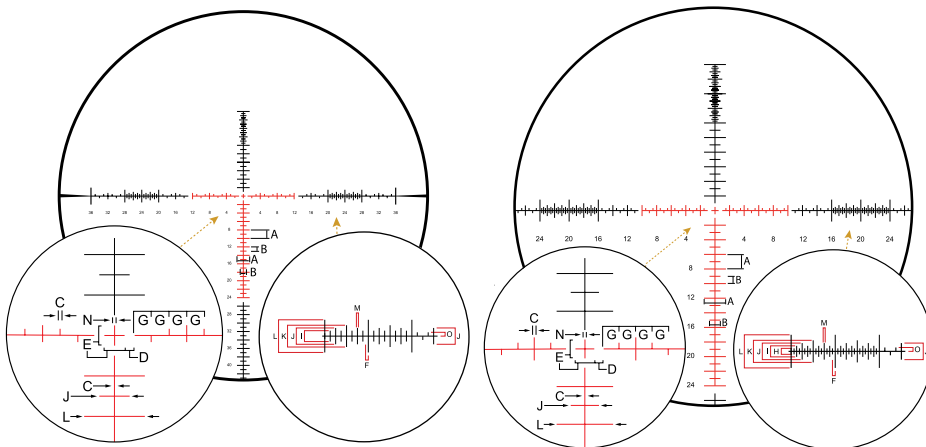

RETICLE SUBTENSIONS (in MOA)

Model	A	B	C	D	E	F	G	H	I	J	K	L	M	N	O
3-15x	2	1	.17	.5	1	.5	1	-	1	1.5	2	3	.1	.15	.5

RETICLE SUBTENSIONS (IN MOA)

Model	A	B	C	D	E	F	G	H	I	J	K	L	M	N	O
5-25x	2	1	.12	.5	1	.25	.5	.7	1	1.5	2	3	.07	.11	.35

C2 RETICLE SUBTENSION

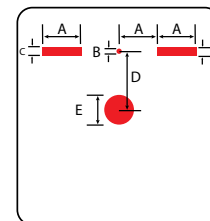

UNIT	MOA
A	18
B	2
C	4
D	27.63
E	13.64

FOR MORE ABOUT THE STEINER RETICLES DOWNLOAD THE STEINER RETICLE GUIDE
www.steiner-optics.com/download-catalog



STEINER BINOCULARS



BLUHORIZON SERIES | 38
SAFARI SERIES | 40
PEREGRINE SERIES | 42
HX SERIES | 44
PREDATOR SERIES | 46
PREDATOR AF SERIES | 48
SHADOWQUEST | 50

LRF 1700 | 52
NAVIGATOR PRO / MARINE | 54
COMMANDER SERIES | 56
MILITARY MARINE SERIES | 58
T-SERIES | 60
M-SERIES | 62
M-SERIES LRF | 64

Binocular Technology

The more light through the lenses, the sharper the image, which is critically important in low-light military situations. Steiner's advanced optics dramatically enhance light transmission, for exceptional clarity in the most challenging conditions. 100% in-house optical capability ensures absolutely consistent, premium lenses and prisms, with world-leading coatings for bright, high-contrast images.



FEATURES:

PROPRIETARY LENS COATINGS



The combination of premium Steiner glass and proprietary lens coatings results in a viewing experience that is second-to-none. All lenses are multicoated, with a variety of specific coatings like the Diamond Night Marine® and Nano-Protection lens coatings that enhance light transmission and provide ultimate protection against dirt, dust and all of Mother Nature's element.

WITHSTANDS 40 G'S OF IMPACT

Steiner's Makrolon® Housing combines an unbreakable polycarbonate frame with a NBR Long Life rubber armoring for a light weight and rugged chassis that can withstand 40 G's of impact. NBR Long Life rubber armoring is durable, slip-proof and noiseless to ensure a secure grip in all conditions.



KNOW THE DIFFERENCE

PORRO PRISM DESIGN

Porro prism binoculars are extremely tough and dependable, creating sharp, clear images and 3D viewing even at long distances.

Always in Focus - with Sports-Auto-Focus™ everything stays in focus from 20-yards to infinity. Makes for easy onehanded operation and effortless low light viewing.



ROOF PRISM DESIGN

Roof prism binoculars are extremely light weight, compact and streamlined, making them easy to pack, carry, hold and use.



FOGPROOF & WATERPROOF

For absolute fogproof and waterproof protection, Steiner seals 14-psi pressurized dry nitrogen into its optics, ensuring premium clarity in any condition. Steiner's proprietary N2 Injection System® pressurizes optics with nitrogen and trace helium. If the seals are not completely tight, hyperbaric testing reveals escaping helium molecules, the optics are disassembled and the process is repeated.





SUPERIOR RUBBER ARMORING

More commonly referred to as Buna-N or Nitrile rubber, NBR (Nitrile butadiene rubber) is a superior rubber armoring. Unlike many other rubbers, it has the ability to withstand oil, fuel, and other chemicals. Another important advantage is that NBR rubber has an excellent resistance to heat aging and thus does not harden or lose its protective capabilities like natural rubber does. NBR characteristics do make an excellent choice as it should withstand dirty and greasy hands as well as being left out in the sun or in a hot car.

WHICH BINOCULAR IS RIGHT FOR YOU?

OUTDOOR				
FEATURE	BluHorizon	Safari	Peregrine	HX
Magnification Options	8x, 10x	8x, 10x	8x, 10x	8x, 10x, 15x
Prism	Roof	Roof	Roof	Roof
Fast-Close-Focus	Yes	Yes	Yes	Yes
Sports-Auto-Focus				
Game-Sensing CAT Coatings				
Nano-Protection Coatings				Yes
Auto-Bright Lens	Yes			
MSRP Range	\$224.99 - \$229.99	\$179.99 - \$354.99	\$549.99 - \$584.99	\$944.99 - \$1,399.99

	Predator	Predator AF	ShadowQuest	LRF 1700
Magnification Options	8x, 10x	8x, 10x	8x	8x
Prism	Roof	Porro	Porro	Porro
Fast-Close-Focus	Yes			
Sports-Auto-Focus		Yes	Yes	Yes
Game-Sensing CAT Coatings	Yes	Yes		
Nano-Protection Coatings	Yes			Yes
Rangefinder Range				1860 yds
MSRP Range	\$229.99 - \$459.99	\$349.99 - \$479.99	\$1,009.99	\$2,344.99

MARINE			
FEATURE	Navigator	Marine	Commander
Magnification Options	7x	7x	7x
Prism	Porro	Porro	Porro
HD Stabilized Compass	Available		Available
Digital Worldwide Compass			Available
Sports-Auto-Focus	Yes	Yes	Yes
High Definition Diamond Marine Coating			Available
Ranging Reticle			Available
MSRP Range	\$529.99 - \$699.99	\$349.99	\$1,229.99 - \$2,749.99

TACTICAL				
FEATURE	Military Marine	T-Series	M-Series	M-Series LRF
Magnification Options	8x, 10x	8x, 10x	7x, 8x, 10x, 15x, 20x	8x, 10x
Prism	Porro	Roof	Porro	Porro
Sports-Auto-Focus	Yes		Yes	Yes
Optics System	High Contrast	High Definition	Fully Multicoated	Fully Multicoated
Reticle		Available	Available	Mil Ranging
HD Stabilized Compass			Available	
Rangefinder Range				1860-6000 yds
MSRP Range	\$224.99 - \$539.99	\$319.99 - \$759.99	\$939.99 - \$2,299.99	\$2,589.99 - \$9,199.99

BLUHORIZONS SERIES

NEW



**WORLD'S FIRST
SUNLIGHT
ADAPTIVE
BINOCULAR.**

ALL THE ACTION
WITHOUT A GLIMMER
OF GLARE.

EXCLUSIVE
AUTOBRIGHT™ OPTICS
OFFSET DAZZLING LIGHT
AUTOMATICALLY, FOR
THE BEST VIEW UNDER
THE SUN.

BLUHORIZONS OVERALL FEATURES

- UNIQUE AUTOBRIGHT™ ADAPTIVE LENS TECHNOLOGY CUTS THROUGH GLARE TO CAPTURE EVERY DETAIL
- PREMIUM OPTICS GIVE YOU A SHARP, CLEAR PICTURE EVERY TIME
- COMPACT, LIGHT WEIGHT AND TEXTURE-ARMORED TO GO ANYWHERE
- IDEAL FOR EVERY ACTIVE OUTDOOR LIFESTYLE, FROM SEASIDE TO SNOWFIELD

BLUHORIZONS 8X22

Tuck this 4-inch marvel into pack, pocket or purse on your way out, for glare-free viewing from 6.6 feet to infinity. Fast-Close Focus, rainproof and rugged, with versatile 8x magnification. It's the trimmest, lightest Sunlight Adaptive optic there is.

ITEM NO. 2043 UPC 840229103508



BLUHORIZONS 10X26

10x AutoBright™ magnification eliminates glare, evaporates distance, and amps the fun of whatever you're doing. At just 10.6 ounces, you can take it everywhere. With powerful 10x magnification, you're close to the action anywhere.

ITEM NO. 2044 UPC 840229103515



Comes with the Steiner logo **BluHorizon Bag.**



Exclusive AutoBright™ Technology

Automatically optimizes lens light transmission in bright conditions. No shimmer or glare from water, sand, snow, or sky. No squinting, guessing, or eye strain, just a perfect image.



Great Feel and Fast Focus

Grippy textured armor, ergonomic body and Fast-Close-Focus™ make clear viewing a pleasure. Wherever bright sun is an issue, you've got a clear solution.



Ergonomic eye cups

Soft silicone rubber cups surround your eyes, keeping side-light, wind, dust and glare from compromising a crisp, comfortable picture.

SPECIFICATIONS

BLUHORIZONS SERIES

	8x22	10x26
ITEM NUMBER	2043	2044
OBJECTIVE DIAMETER (MM)	22	26
MAGNIFICATION	8x	10x
FIELD OF VIEW AT 1,000 YD. (FT.)	410	321.5
FOCUSING SYSTEM	Fast-Close-Focus™	Fast-Close-Focus™
CLOSE FOCUS RANGE (FT.)	6.6	9.8
EXIT PUPIL (MM)	2.75	2.6
LUMINOSITY	7.56	12.4
TWILIGHT FACTOR	13.27	16.12
EYECUPS	Ergonomic	Ergonomic
RUBBER ARMORING	NBR Long Life	NBR Long Life
WATERPROOF	Rainproof IPX4	Rainproof IPX4
TEMPERATURE RANGE	-20°C to +70°C	-20°C to +70°C
WEIGHT (OZ.)	8.8	10.6
DIMENSIONS (IN.) (HxWxD)	4x4.6x1.8	4.5x4.6x1.8
NECK STRAP	Comfort	Comfort
NECK STRAP ATTACHMENT	Fixed	Fixed
OBJECTIVE COVER	No	No
RAIN PROTECTION CAP	No	No
CARRY CASE	Neoprene Outdoor	Neoprene Outdoor
WARRANTY	Heritage™ Warranty	Heritage™ Warranty
MSRP PRICE	\$224.99	\$229.99

The Steiner Heritage Warranty means we stand behind our products. Over half a century of building rugged and reliable product for armed forces around the world gives us this confidence.



We will repair or replace your product at no charge to you. It covers all riflescopes and binoculars sold in the US and Canada for the life of the product.

See full warranty details at www.steineroptics.com/product-warranties

- No warranty card needed.
- No receipt required.
- Warranty is fully transferable to future owners of the product.
- Electronic components are covered by a 3-year warranty.



SAFARI SERIES



COMPACT AND
CAPABLE
IS NOT A
CONTRADICTION.

NOBODY BUT STEINER
COULD COMBINE
FEATHERLIGHT WEIGHT,
HIGH PERFORMANCE,
SMALL SIZE, AND
RAZOR-SHARP IMAGES
INTO A SINGLE, WELL-
ARMORED TOOL.

.....

SAFARI SERIES OVERALL FEATURES

- HIGH-CONTRAST OPTICS
- COMPACT & LIGHTWEIGHT
- TWIST-UP EYECUPS

10X26 SAFARI 10X26

A compact sport optic that looks great, fits your pack, pocket or purse, and is your constant companion for quick use.

ITEM NO. 2040 UPC 840229103157



8X42 SAFARI 8X42

Versatile combination of high power and wide field of view, a great choice or your daypack, glove box or birding stand.

ITEM NO. 2041 UPC 840229103164



10X42 SAFARI 10X42

10x magnification shows you more detail from farther away, perfect for sports events and wildlife observation.

ITEM NO. 2042 UPC 840229103171





Steiner High-Contrast-Optics

Provide bright, brilliant views, accurate color, and clear images for exceptional performance up to a close range of 2 m.



Ergonomic Design

Rubber armoured controls provide comfortable and silent observations with effective sound absorption.



Twist-Up Eyecups

Easy to adjust when wearing eyeglasses or sunglasses.

SPECIFICATIONS

SAFARI SERIES

	10x26	8x42	10x42
ITEM NUMBER	2040	2041	2042
OBJECTIVE DIAMETER (MM)	26	42	42
MAGNIFICATION	10x	8x	10x
FIELD OF VIEW AT 1,000 YD. (FT.)	312	380	328
FOCUSING SYSTEM	Fast-Close-Focus™	Fast-Close-Focus™	Fast-Close-Focus™
OPTICS SYSTEM	High Contrast	High Contrast	High Contrast
CLOSE FOCUS (FT.)	9.8	6	6
EXIT PUPIL (MM)	2.6 mm	5.3 mm	4.2 mm
LUMINOSITY	6,25	27,6	17,6
TWILIGHT FACTOR	15,81	18,3	20,5
EYECUPS	Cylindrical Rotation	Cylindrical Rotation	Cylindrical Rotation
RUBBER ARMORING	NBR Long Life	NBR Long Life	NBR Long Life
WATERPROOF	Yes	Yes	Yes
WEIGHT (OZ.)	10	24.6	25
DIMENSIONS (IN.) (HxWxD)	4.4 x 4 x 1.8	5.8 x 5 x 2.6	5.8 x 5 x 2.5
NECK STRAP	Standard	Standard	Standard
NECK STRAP ATTACHMENT	Fixed	Fixed	Fixed
CARRY CASE	Yes	Yes	Yes
WARRANTY	Heritage™ Warranty (U.S.)	Heritage™ Warranty (U.S.)	Heritage™ Warranty (U.S.)
MSRP PRICE	\$179.99	\$344.99	\$354.99

The Steiner Heritage Warranty means we stand behind our products. Over half a century of building rugged and reliable product for armed forces around the world gives us this confidence.



We will repair or replace your product at no charge to you. It covers all riflescopes and binoculars sold in the US and Canada for the life of the product.

See full warranty details at www.steineroptics.com/product-warranties

- No warranty card needed.
- No receipt required.
- Warranty is fully transferable to future owners of the product.
- Electronic components are covered by a 3-year warranty.

PEREGRINE SERIES

NEW



THE
BIRDER'S
BINOCULAR.

FINDING, FOLLOWING
AND IDENTIFYING
REQUIRES A
SPECIALIZED BALANCE
OF POWER, CLARITY,
COLOR AND COMFORT.
HERE IT IS.

PEREGRINE 8X42

Wide field of view, bright image and high image stability make finding and following faster and easier, even in low light. Versatile choice for all kinds of viewing.

ITEM NO. 2050 UPC 840229104390



PEREGRINE SERIES OVERALL FEATURES

- PHASE COATED HIGH-CONTRAST LENSES
- FAST CLOSE FOCUS™ DOWN TO 2 YARDS
- DISTANCE-CONTROL SYSTEM FOR RAPID VIEW
- RUBBER-ARMORED MAKROLON® HOUSING
- WATERPROOF, FOGPROOF, SHOCKPROOF
- LIGHTWEIGHT, PACKABLE ROOF PRISM DESIGN
- ERGONOMIC FRAME AND EYECUPS

PEREGRINE 10X42

Higher 10x magnification reveals greater long-distance detail, making it ideal for viewing far-off subjects like raptors, waterfowl and wildlife, especially in open country.

ITEM NO. 2051 UPC 840229104406





Phase coated optics

Provide bright, true color, sharp 3D images, and exceptionally fine detail for positive identification.



Fast-Close Focus

Delivers a razor-sharp image as close as 2 yards, letting you use a single optic for clear viewing at any distance.



Distance Control System

Lets you pre-set focus at a known distance, for a fast, clear view you can fine-tune with a quick wheel turn.

SPECIFICATIONS

PEREGRINE SERIES

	8x42	10x42
ITEM NUMBER	2050	2051
OBJECTIVE DIAMETER (MM)	42	42
MAGNIFICATION	8 x	10x
FIELD OF VIEW AT 1,000 YD. (M.)	125	108
FOCUSING SYSTEM	Fast-Close-Focus	Fast-Close-Focus
OPTICS SYSTEM	Fast-Close-Focus	Fast-Close-Focus
CLOSE FOCUS RANGE (FT.)	6.6	6.6
EXIT PUPIL (MM)	5.25	4.2
LUMINOSITY	27.65	17.64
TWILIGHT FACTOR	18.33	20.49
EYECUPS	Ergonomic Rotary Eyecups	Ergonomic Rotary Eyecups
RUBBER ARMORING	NBR-Longlife	NBR-Longlife
WATERPROOF	Up to 9.84 ft.	Up to 9.84 ft.
WEIGHT (OZ.)	26.6	26.3
TEMPERATURE RANGE	-20° to +70° C	-20° to +70° C
DIMENSIONS (IN.) (HxWxD)	6.9x4.73x2.5	6.9x4.73x2.5
NECK STRAP	Neoprene	Neoprene
NECK STRAP ATTACHMENT	Universal	Universal
OBJECTIVE COVER	Yes	Yes
RAIN PROTECTION CAP	Yes	Yes
CARRY CASE	Yes	Yes
WARRANTY	Heritage Warranty	Heritage Warranty
MSRP PRICE	\$549.99	\$584.99

The Steiner Heritage Warranty means we stand behind our products. Over half a century of building rugged and reliable product for armed forces around the world gives us this confidence.



We will repair or replace your product at no charge to you. It covers all riflescopes and binoculars sold in the US and Canada for the life of the product.

See full warranty details at www.steineroptics.com/product-warranties

- No warranty card needed.
- No receipt required.
- Warranty is fully transferable to future owners of the product.
- Electronic components are covered by a 3-year warranty.

STEINER 
Nothing Escapes You



HX SERIES



**MORE THAN
GAME FINDING.
GAME
CHANGING.**

PICK YOUR CHALLENGE, AND THERE'S AN HX TO MASTER IT. FROM DARK WOODS TO SUNLIT RIDGES, LOWLAND BOGS TO THE HIGH PLAINS. NEW OPTICAL APPROACHES AND FRAME DESIGNS PROMISE BRIGHTER, CLEARER IMAGES, EXTENDED FIELD OF VIEW, EASIER HANDLING, AND ALL-WEATHER TOUGHNESS BRINGS MORE SUCCESS TO EVERY HUNT.

**HX SERIES
OVERALL FEATURES**

- BRIGHT, CRISP IMAGES
- WIDE FIELD OF VIEW
- FAST-CLOSE FOCUS™
- STEINER NANO PROTECTION®
- FOGPROOF & WATERPROOF DOWN TO 16 FEET

15X56 HX 15X56

Steiner's most powerful hunting binocular. Massive 15x magnification and larger objectives provide exceptional long-range clarity to spot and judge trophy animals on distant ridges. Tripod mountable to make remote views rock-steady; tripod adapters available.

ITEM NO. 2018 UPC 840229101146



10X56 HX 10X56

Large 56 mm objectives gather extra light to penetrate shadows, pick out details, and brighten images, revealing hidden game that others miss.

ITEM NO. 2017 UPC 840229101726



10X42 HX 10X42

HD optics, enhanced lens coatings and 10x magnification deliver bright images for dim light conditions and high detail at longer ranges. Ideal for wide open country and hilly regions.

ITEM NO. 2015 UPC 840229101719



8X42 HX 8X42

Small enough for effortless carry, with a wide field of view to sweep distant terrain and put you on game faster. 8x magnification brings wildlife close and clear, perfect for bow hunting or eastern whitetail hunting where game is active at dawn and dusk.

ITEM NO. 2014 UPC 840229101702





New Frame Design

The HX binoculars is easier to grip, more comfortable for extending scouting.



Nano-Protection®

Hydrophobic molecular coating creates a lens surface so smooth, water sheets off and dirt, dust are repelled.



Ergonomic Eyecups

Comfortable and protect your eyes against side light and drafts.



Fast-Close-Focus™

Central focusing wheel requires minimal rotation for quick, absolute sharpness from up close to infinity.

SPECIFICATIONS

HX SERIES

	8x42	10x42	10x56	15x56
ITEM NUMBER	2014	2015	2017	2018
OBJECTIVE DIAMETER (MM)	42	42	56	56
MAGNIFICATION	8x	10x	10x	15x
FIELD OF VIEW AT 1,000 YD. (FT.)	377	326	332	241
FOCUSING SYSTEM	Fast-Close-Focus™	Fast-Close-Focus™	Fast-Close-Focus™	Fast-Close-Focus™
OPTICS SYSTEM	High Definition	High Definition	High Definition	High Definition
CLOSE FOCUS (FT.)	6	6	8	8
EXIT PUPIL (MM)	5.25	4.2	5.6	3.7
LUMINOSITY	27.6	17.6	31.7	13.9
TWILIGHT FACTOR	18.3	20.5	23.7	28.9
COMPASS	-	-	-	-
EYECUPS	Ergonomic	Ergonomic	Ergonomic	Ergonomic
RUBBER ARMORING	NBR Long Life	NBR Long Life	NBR Long Life	NBR Long Life
WATERPROOF	Submersion to 10 ft.	Submersion to 10 ft.	Submersion to 10 ft.	Submersion to 10 ft.
WEIGHT (OZ.)	27.7	28	42.3	44.1
DIMENSIONS (IN.) (HxWxD)	5.8 x 4.9 x 2.6	5.8 x 4.9 x 2.6	7.1 x 5.6 x 3.1	7.1 x 5.6 x 3.1
NECK STRAP	Neoprene	Neoprene	Neoprene	Neoprene
NECK STRAP ATTACHMENT	ClicLoc®	ClicLoc®	ClicLoc®	ClicLoc®
OBJECTIVE COVER	Yes	Yes	Yes	Yes
RAIN PROTECTION CAP	Yes	Yes	Yes	Yes
CARRY CASE	Yes	Yes	Yes	Yes
BATTERY	-	-	-	-
SPECIAL FEATURES	Steiner Nano Protection®	Steiner Nano Protection®	Steiner Nano Protection®	Steiner Nano Protection®
WARRANTY	Heritage™ Warranty	Heritage™ Warranty	Heritage™ Warranty	Heritage™ Warranty
MSRP PRICE	\$944.99	\$999.99	\$1,174.99	\$1,399.99

The Steiner Heritage Warranty means we stand behind our products. Over half a century of building rugged and reliable product for armed forces around the world gives us this confidence.



We will repair or replace your product at no charge to you. It covers all riflescopes and binoculars sold in the US and Canada for the life of the product.

- See full warranty details at www.steineroptics.com/product-warranties
- No warranty card needed.
 - No receipt required.
 - Warranty is fully transferable to future owners of the product.
 - Electronic components are covered by a 3-year warranty.



PREDATOR SERIES



**GERMAN
PRECISION
MEETS
AMERICAN
UTILITY.**

THE IDEAL COMPANION FOR SKILLED HUNTERS ON THE MOVE: COMPACT, VERSATILE, TOUGH AS A ROCK AND LIGHT AS A BREEZE. IT'S THE BEST OF GERMAN PRECISION AND PERFORMANCE.

PREDATOR 10X26

10x power for great long-range detail, perfect for wide-open country and hilly regions with scattered game.

ITEM NO. 2442 UPC 840229100675



PREDATOR 8X42

From close up to far away, this mid-sized binocular delivers bright, crisp images without added bulk or weight.

ITEM NO. 2443 UPC 840229100682



PREDATOR SERIES OVERALL FEATURES

- OPTIMIZED LIGHT TRANSMISSION
- CAT™ LENS COATINGS
- LIGHTWEIGHT DESIGN
- FAST-CLOSE-FOCUS™
- MAKROLON® HOUSING
- WATERPROOF & FOGPROOF
- SHOCKPROOF
- CLICLOC® SYSTEM

PREDATOR 10X42

An all-around favorite. Versatile enough for Western big game hunters or Eastern whitetail hunters.

ITEM NO. 2444 UPC 840229100699





CAT™ Lens Coatings

Amplifies contrast in the peak human vision sensitivity range, to spot game in any environment.



Fast-Close-Focus™

Central focusing wheel requires minimal rotation for quick absolute sharpness from close-up to infinity.



Makrolon® Housing

Durable polycarbonate NBR Long Life rubber armoring for a chassis that can withstand 40 Gs of impact.

SPECIFICATIONS

PREDATOR SERIES

	10x26	8x42	10x42
ITEM NUMBER	2442	2443	2444
OBJECTIVE DIAMETER (MM)	26	42	42
MAGNIFICATION	10x	8x	10x
FIELD OF VIEW AT 1,000 YD. (FT.)	302	381	328
FOCUSING SYSTEM	Fast-Close-Focus™	Fast-Close-Focus™	Fast-Close-Focus™
OPTICS SYSTEM	High Contrast CAT™ Color Adjusted Transmission Coatings	High Contrast CAT™ Color Adjusted Transmission Coatings	High Contrast CAT™ Color Adjusted Transmission Coatings
CLOSE FOCUS (FT.)	10	6	6
EXIT PUPIL (MM)	2.6	5.3	4.2
LUMINOSITY	6.7	27.6	17.6
TWILIGHT FACTOR	16.1	18.4	20.5
COMPASS	-	-	-
EYECUPS	Ergonomic	Ergonomic	Ergonomic
RUBBER ARMORING	NBR Long Life	NBR Long Life	NBR Long Life
WATERPROOF	Yes	Submersion to 3 ft.	Submersion to 3 ft.
WEIGHT (OZ.)	10.4	26.1	26.5
DIMENSIONS (IN.) (HxWxD)	4.9 x 4.1 x 1.8	6.9 x 4.9 x 2.5	6.9 x 4.9 x 2.5
NECK STRAP	Yes	Neoprene	Neoprene
NECK STRAP ATTACHMENT	Fixed	ClicLoc®	ClicLoc®
OBJECTIVE COVER	-	Yes	Yes
RAIN PROTECTION CAP	Yes	Yes	Yes
CARRY CASE	Yes	Yes	Yes
BATTERY	-	-	-
SPECIAL FEATURES	CAT™ Color Adjusted Transmission Coatings	CAT™ Color Adjusted Transmission Coatings	CAT™ Color Adjusted Transmission Coatings
WARRANTY	Heritage™ Warranty	Heritage™ Warranty	Heritage™ Warranty
MSRP PRICE	\$229.99	\$449.99	\$459.99

The Steiner Heritage Warranty means we stand behind our products. Over half a century of building rugged and reliable product for armed forces around the world gives us this confidence.



We will repair or replace your product at no charge to you. It covers all riflescopes and binoculars sold in the US and Canada for the life of the product.

See full warranty details at www.steineroptics.com/product-warranties

- No warranty card needed.
- No receipt required.
- Warranty is fully transferable to future owners of the product.
- Electronic components are covered by a 3-year warranty.



PREDATOR AF SERIES

NEW



**AUTO-FOCUS
VISION FOR
APEX
PREDATORS.**

ONE GLANCE GIVES
YOU DEAD-ACCURATE
PERCEPTION,
WHEREVER YOUR
PREY MAY HIDE.

PREDATOR AF 8X30

Compact, lightweight and Auto-Focus quick for predators on the move. Versatile 8x30 power combines sharp detail and good field of view, while advanced CAT™ lenses pop game from background. Nothing unseen, nothing escapes you.



ITEM NO. 2045 UPC 840229103522

PREDATOR AF SERIES OVERALL FEATURES

- NEXT-GEN TECH FOR THE ULTIMATE HUNTING BINOCULAR
- INSTANT FOCUS AT ANY DISTANCE
- ENHANCED 3D DEPTH AND DETAIL
- CAT™ GAME-SENSING LENSES
- OPTIMIZED LIGHT TRANSMISSION
- LEANER, LIGHTER WHEEL-FREE BRIDGE
- WATERPROOF, FOGPROOF, SHOCKPROOF
- RUGGED MAKROLON® HOUSING
- LASER-ETCHED TEXTURE FOR SECURE GRIP
- DEPENDABLE CLICLOC® SYSTEM

PREDATOR AF 10X42

Closer, wider view for the most demanding hunts, with Auto-Focus to keep vision sharp from 20 yards to infinity. Bright picture and advanced CAT™ lenses pierce shadow and cover to reveal bigger, smarter game other hunters don't see.



ITEM NO. 2046 UPC 840229103539



CAT™ Lens Coatings

Amplifies contrast in the peak human vision sensitivity range, to spot game in any environment.



Easy Auto-Focus

Adjust each eyepiece to your vision once, for sharp, clear images from 20 yards to infinity. No twisting a wheel, no chasing focus on the move, no lost chances.



Wheel-Free Open Bridge

Design reduces bulk and weight for easy carry and handling, a secure grip wet or dry, and more comfortable scouting wherever you hunt.

SPECIFICATIONS

PREDATOR AF SERIES

	8x30	10x42
ITEM NUMBER	2045	2046
OBJECTIVE DIAMETER (MM)	30	42
MAGNIFICATION	8x	10x
FIELD OF VIEW AT 1,000 YD. (FT.)	302	381
FOCUSING SYSTEM	Auto-Focus™	Auto-Focus™
OPTICS SYSTEM	High Contrast CAT™ Color Adjusted Transmission Coatings	High Contrast CAT™ Color Adjusted Transmission Coatings
CLOSE FOCUS RANGE (FT.)	10	6
EXIT PUPIL (MM)	15	16.8
LUMINOSITY	14.06	17.64
TWILIGHT FACTOR	15.49	20.49
COMPASS	-	-
EYECUPS	Ergonomic	Ergonomic
RUBBER ARMORING	NBR Long Life	NBR Long Life
WATERPROOF	Rainproof IPX4	Rainproof IPX4
WEIGHT (OZ.)	19	30.3
TEMPERATURE RANGE	-20°C to +70°C	-20°C to +70°C
DIMENSIONS (IN.) (HxWxD)	4.7 x 6.5 x 2.1	5.9 x 7.5 x 2.6
NECK STRAP	Comfort Plus	Comfort Plus
NECK STRAP ATTACHMENT	Fixed	Fixed
OBJECTIVE COVER	Yes	Yes
RAIN PROTECTION CAP	Yes	Yes
CARRY CASE	Yes	Yes
BATTERY	-	-
SPECIAL FEATURES	CAT™ Color Adjusted Transmission Coatings	CAT™ Color Adjusted Transmission Coatings
WARRANTY	Heritage™ Warranty	Heritage™ Warranty
MSRP PRICE	\$349.99	\$479.99

The Steiner Heritage Warranty means we stand behind our products. Over half a century of building rugged and reliable product for armed forces around the world gives us this confidence.



We will repair or replace your product at no charge to you. It covers all riflescopes and binoculars sold in the US and Canada for the life of the product.

See full warranty details at www.steineroptics.com/product-warranties

- No warranty card needed.
- No receipt required.
- Warranty is fully transferable to future owners of the product.
- Electronic components are covered by a 3-year warranty.

SHADOWQUEST



**#1 IN
LOW
LIGHT
PERFORMANCE.**



SHADOWQUEST DELIVERS THE INDUSTRY'S HIGHEST LIGHT GATHERING OPTICS TO PROVIDE UNMATCHED CLARITY IN LOW LIGHT. STEINER'S DIAMOND NIGHT™ LENS COATINGS CUTS THROUGH THE DARKNESS PROVIDING REMARKABLE SHARP FOCUS AND DETAIL IN ALL LIGHTING CONDITIONS.

SHADOWQUEST 8X56

Experience the next evolutionary step in lowlight binoculars. This technology, combined with Steiner's Sports-Auto Focus™, it produces the ultimate optic for low-light observation. The Steiner ShadowQuest – it's almost like having an unfair advantage.



ITEM NO. 2039 UPC 840229103089

.....

SHADOWQUEST OVERALL FEATURES

- BEST IN THE INDUSTRY LIGHT TRANSMISSION (96%+)
- CLARITY IN LOW LIGHT
- SPORTS-AUTO-FOCUS™
- STEINER LUMICLIP™
- WIDE FIELD OF VIEW
- MILITARY RUGGEDNESS, PRECISION AND PERFORMANCE



Best in the Industry Light Transmission (96%+)

With the industry's highest light transmission, they add critical minutes to your hunt.



Clarity in Low Light

Steiner's proprietary Diamond Night™ lens coating formula uses rare-earth materials to deliver virtually all available light to your eye.



New Steiner Lumiclip™

Simple and innovative. The luminescent clip glows with just enough light to easily locate your binoculars in the darkest hours.



Sports-Auto-Focus

Once each eyepiece is set to your vision, everything from 20 yards to infinity is in razor-sharp focus.

SPECIFICATIONS

SHADOWQUEST

8x56

ITEM NUMBER	2039
OBJECTIVE DIAMETER (MM)	56
MAGNIFICATION	8x
FIELD OF VIEW AT 1,000 YD. (FT.)	441
FOCUSING SYSTEM	Sports-Auto-Focus™
LIGHT TRANSMISSION	96%+
CLOSE FOCUS (FT.)	66
EXIT PUPIL (MM)	7.0
LUMINOSITY	49
TWILIGHT FACTOR	21.2
EYECUPS	Ergonomic
RUBBER ARMORING	NBR Long Life
WATERPROOF	Submersion to 16 ft.
WEIGHT (OZ.)	38.45
DIMENSIONS (IN.) (WxH)	7.8 x 8.3
NECK STRAP	Neoprene
NECK STRAP ATTACHMENT	ClicLoc®
OBJECTIVE COVER	Included
N ₂ INJECTION SYSTEM	14-psi pressurized Nitrogen-filled
RAIN PROTECTION CAP	Included
CARRY CASE	Yes
WARRANTY	Heritage™ Warranty
MSRP PRICE	\$1,009.99

The Steiner Heritage Warranty means we stand behind our products. Over half a century of building rugged and reliable product for armed forces around the world gives us this confidence.

We will repair or replace your product at no charge to you. It covers all riflescopes and binoculars sold in the US and Canada for the life of the product.

See full warranty details at www.steineroptics.com/product-warranties

- No warranty card needed.
- No receipt required.
- Warranty is fully transferable to future owners of the product.
- Electronic components are covered by a 3-year warranty.



STEINER 
Nothing Escapes You

LRF 1700



**SPOT YOUR
TARGET
PLUS SPOT ON
RANGING WITH
ONE OPTIC.**

**GAME-FINDING
PRECISION OPTICS
AND PINPOINT LASER
RANGING, ALL IN
ONE COMPACT
BINOCULAR.**

8X30 LRF 1700
8X30

Hunters prefer Steiner porro prism binoculars for their enhanced three-dimensional depth perception and military-grade toughness. When combined with a fast, accurate laser rangefinder, they quickly become a trusted and practical additional to your hunting gear.

Quickly and easily find your target and accurately range out to 1,700 yards without juggling multiple optics.



**LRF 1700 SERIES
OVERALL FEATURES**

- LASER RANGEFINDER
- SPORTS-AUTO FOCUS™
- STEINER NANO-PROTECTION®
- FOGPROOF & WATERPROOF
DOWN TO 16 FEET
- SHOCKPROOF

MAGNIFICATION 8X
WEIGHT 28 OZ. | WIDTH 6.5 IN.
HEIGHT 5.7 IN.
ITEM NO. 2315
UPC 840229102990



Steiner Nano-Protection®

Hydrophobic molecular coating creates a lens surface so smooth, water sheets off and dirt, dust are repelled.



Fogproof & Waterproof

For absolute protection, Steiner injects 14-psi pressurized dry nitrogen into its optics for premium clarity.



Shockproof

Lenses and prisms are built into unbreakable binocular housings that are armored to withstand harsh conditions.

SPECIFICATIONS

LRF 1700 8x30 LRF

ITEM NUMBER	2315
OBJECTIVE DIAMETER (MM)	30
MAGNIFICATION	8x
FIELD OF VIEW AT 1,000 YD. (FT.)	374
FOCUSING SYSTEM	Sports-Auto-Focus™
OPTICS SYSTEM	High Definition
CLOSE FOCUS (FT.)	66
EXIT PUPIL (MM)	3.8
LUMINOSITY	14
TWILIGHT FACTOR	15.5
COMPASS	-
EYECUPS	ErgoFlex
RUBBER ARMORING	NBR Long Life
WATERPROOF	Submersion to 16 ft.
WEIGHT (OZ.)	28
DIMENSIONS (IN.) (HxWxD)	4.9 x 5.5 x 2.3
NECK STRAP	Yes
NECK STRAP ATTACHMENT	Standard
OBJECTIVE COVER	Yes
RAIN PROTECTION CAP	Yes
CARRY CASE	Yes
BATTERY	CR2
SPECIAL FEATURES	Laser Rangefinder Measuring Range: 27 to 1,859 Yd.
WARRANTY	Heritage™ Warranty
MSRP PRICE	\$2,344.99

The Steiner Heritage Warranty means we stand behind our products. Over half a century of building rugged and reliable product for armed forces around the world gives us this confidence.

We will repair or replace your product at no charge to you. It covers all riflescopes and binoculars sold in the US and Canada for the life of the product.

See full warranty details at www.steineroptics.com/product-warranties

- No warranty card needed.
- No receipt required.
- Warranty is fully transferable to future owners of the product.
- Electronic components are covered by a 3-year warranty.



STEINER
Nothing Escapes You

NAVIGATOR PRO AND MARINE SERIES



NEVER
COMPROMISE
PERFORMANCE
JUST BECAUSE
IT'S FUN.

SERIOUS OPTICS FOR
THOSE WHO TAKE
RECREATIONAL TIME ON
THE WATER SERIOUSLY,
WITH THE CLEAR IMAGE,
TOTAL RELIABILITY AND
REMARKABLE VALUE
STEINER MARINE OPTICS
ARE KNOWN FOR.

NAVIGATOR PRO 7X50c

Carries an HD fluid-damped, illuminated
analog compass for easy-to-read navigation.

ITEM NO. 7155 UPC 840229100712



NAVIGATOR PRO 7X50

Delivers excellent image clarity, sharp definition
and contrast, and oversized light-gathering
objective for a bright picture in low light.

ITEM NO. 7655 UPC 840229100736



NAVIGATOR PRO AND MARINE SERIES OVERALL FEATURES

- 7X MAGNIFICATION - THE MARINE INDUSTRY STANDARD
- HIGH-CONTRAST OPTICS
- FLOATING PRISM SYSTEM
- SPORTS-AUTO-FOCUS™ SYSTEM
- SHOCKPROOF

MARINE 7X50

The perfect first pair of quality, water-going binoculars,
for enthusiasts who want the most performance
for their money.

ITEM NO. 575 UPC 000381805751



HD Stabilized Compass

Integrated fluid damped, illuminated compass it is an accurate and invaluable viewing and navigation tool. Available on the 7x50c only.



100% In-House Optics

Premium lenses and BaK4 prisms have proprietary coatings for unmatched brightness and clarity.



Sports-Auto-Focus™

Focus each eyepiece to your vision once, then keep images razor sharp from 20 yards to infinity. No more chasing focus on moving objects.

SPECIFICATIONS

	Navigator Pro		Marine
	7x50	7x50c	7x50
ITEM NUMBER	7655	7155	575
OBJECTIVE DIAMETER (MM)	50	50	50
MAGNIFICATION	7x	7x	7x
FIELD OF VIEW AT 1,000 YD. (FT.)	370	370	356
FOCUSING SYSTEM	Sports-Auto-Focus™	Sports-Auto-Focus™	Sports-Auto-Focus™
OPTICS SYSTEM	High Contrast	High Contrast	High Contrast
CLOSE FOCUS (FT.)	66	66	66
EXIT PUPIL (MM)	7.1	7.1	7.1
LUMINOSITY	51	51	51
TWILIGHT FACTOR	18.7	18.7	18.7
COMPASS	-	HD Stabilized	-
EYECUPS	Cylindrical	Cylindrical	Cylindrical
RUBBER ARMORING	NBR Long Life	NBR Long Life	NBR Long Life
WATERPROOF	Submersion to 16 ft.	Submersion to 16 ft.	Yes
WEIGHT (OZ.)	36.3	39.2	36.3
DIMENSIONS (IN.) (HxWxD)	5.5 x 8.1 x 3	5.5 x 8.1 x 3.8	5.5 x 8.1 x 3
NECK STRAP	Neoprene	Neoprene	Comfort
NECK STRAP ATTACHMENT	ClicLoc®	ClicLoc®	Standard
OBJECTIVE COVER	Yes	Yes	Yes
RAIN PROTECTION CAP	Yes	Yes	Yes
CARRY CASE	Yes	Yes	Yes
BATTERY	-	CR1225	-
SPECIAL FEATURES	-	Compass with bearing mark	-
WARRANTY	Heritage™ Warranty	Heritage™ Warranty	Heritage™ Warranty
MSRP PRICE	\$529.99	\$699.99	\$349.99

The Steiner Heritage Warranty means we stand behind our products. Over half a century of building rugged and reliable product for armed forces around the world gives us this confidence.



We will repair or replace your product at no charge to you. It covers all riflescopes and binoculars sold in the US and Canada for the life of the product.

See full warranty details at www.steineroptics.com/product-warranties

- No warranty card needed.
- No receipt required.
- Warranty is fully transferable to future owners of the product.
- Electronic components are covered by a 3-year warranty.

COMMANDER SERIES



THE WORLDWIDE
FLAGSHIP
OF MARINE
BINOCULARS.

THE CHOICE FOR
ANYONE WHO LIVES
ABOARD OR MAKES
THEIR LIVING ON
THE WATER



COMMANDER GLOBAL 7X50

Steiner's finest marine binocular. The integrated digital compass with electronic magnetic field measurement and automatic declination adjustment delivers precise readings anywhere in the world. Experience astounding clarity with Diamond Marine™ lens coatings for outstanding light transmission and high-definition optics.

ITEM NO. 4961 UPC 000381849618

COMMANDER OVERALL FEATURES

- 7X MAGNIFICATION
- THE MARINE INDUSTRY STANDARD
- OUTSTANDING COMPASS TECHNOLOGY
- MAKROLON® HOUSING
- DIAMOND MARINE™ OR NANO-PROTECTION® LENS COATINGS
- SPORTS-AUTO-FOCUS™
- MEMORY OCULAR SAVES PERSONAL DIOPTRER SETTINGS
- FOGPROOF & WATERPROOF DOWN TO 33 FEET
- SHOCKPROOF



COMMANDER 7X50c

This military-grade porro prism Commander binocular with HD Stabilized compass is the choice for serious navigation.

ITEM NO. 2305 UPC 840229101214



COMMANDER 7X50

Delivers top-of-the-line image clarity, sharp edge-to-edge definition and contrast, and high light transmission for navigating in low light or fog.

ITEM NO. 2304 UPC 840229101207

Digital Worldwide Compass

Available only on the Commander Global is an Integrated digital compass with electronic magnetic field measurement and declination adjustment delivers precise readings anywhere in the world.



HD Stabilized Compass

The integrated fluid damped, HD Stabilized illuminated compass with ranging reticle creates one accurate and invaluable navigation tool. Available on the Commander 7x50c only.



SPECIFICATIONS

	Global 7x50 4961	7x50c 2305	7x50 2304
OBJECTIVE DIAMETER (MM)	50	50	50
MAGNIFICATION	7x	7x	7x
FIELD OF VIEW AT 1,000 YD. (FT.)	392	438	438
FOCUSING SYSTEM	Sports-Auto-Focus™	Sports-Auto-Focus™	Sports-Auto-Focus™
OPTICS SYSTEM	High Definition Diamond Marine™ Coating	High Definition	High Definition
CLOSE FOCUS (FT.)	66	66	66
EXIT PUPIL (MM)	7.1	7.1	7.1
LUMINOSITY	51	51	51
TWILIGHT FACTOR	18.7	18.7	18.7
COMPASS	Worldwide Digital	HD Stabilized	-
EYECUPS	Ergoflex	Ergoflex	Ergoflex
RUBBER ARMORING	NBR Long Life	NBR Long Life	NBR Long Life
WATERPROOF	Submersion to 33 ft.	Submersion to 33 ft.	Submersion to 33 ft.
WEIGHT (OZ.)	40.5	42	38.4
DIMENSIONS (IN.) (HxWxD)	6.1 x 8.1 x 3.9	6.2 x 8.1 x 3.8	6.2 x 8.1 x 3
NECK STRAP	Floating strap	Floating strap	Floating strap
NECK STRAP ATTACHMENT	ClicLoc®	ClicLoc®	ClicLoc®
OBJECTIVE COVER	Yes	Yes	Yes
RAIN PROTECTION CAP	Yes	Yes	Yes
CARRY CASE	Yes	Yes	Yes
BATTERY	CR2	CR1/3N	-
SPECIAL FEATURES	Steiner Nano Protection®, Precision Reticle	Ranging Reticle, Steiner Nano Protection®	Steiner Nano Protection®
WARRANTY	Heritage™ Warranty	Heritage™ Warranty	Heritage™ Warranty
MSRP PRICE	\$2,749.99	\$1,524.99	\$1,229.99

The Steiner Heritage Warranty means we stand behind our products. Over half a century of building rugged and reliable product for armed forces around the world gives us this confidence.



We will repair or replace your product at no charge to you. It covers all riflescopes and binoculars sold in the US and Canada for the life of the product.

See full warranty details at www.steineroptics.com/product-warranties

- No warranty card needed.
- No receipt required.
- Warranty is fully transferable to future owners of the product.
- Electronic components are covered by a 3-year warranty.

MILITARY/ MARINE SERIES



**PROVEN ON THE
BATTLEFIELD.
PERFECT FOR
EVERYTHING ELSE.**

THE CIVILIAN
VERSION OF OUR
PROVEN MILITARY
BINOCULARS,
ADAPTED FOR RUGGED
ALL-AROUND USE. AS
SHARP, CLEAR AND
BATTLE-WORTHY AS
THE WARRIOR MODELS
THEY'RE BASED ON.

.....

MILITARY/MARINE SERIES OVERALL FEATURES

- FLOATING PRISM SYSTEM
- COMPACT DESIGN
- SPORTS-AUTO-FOCUS™ SYSTEM
- MAKROLON® HOUSING



MM1050 10X50

The choice of many State and Federal agencies for field use, the large 50mm objective lenses and powerful 10x magnification makes this a good choice for big game hunters as well.

ITEM NO. 2035 UPC 840229103119



MM750 7X50

Based on the same design as the M22 binoculars chosen by the U.S. Army, the rugged and dependable 7x50 binoculars will stand up a lifetime of civilian use and abuse.

ITEM NO. 2038 UPC 840229103140



MM830 8X30

Light and easy to handle, with for bright images and a wide field of view for steady viewing, even on the move.

ITEM NO. 2033 UPC 840229103102



MM1025 10X25

Similar in style and function to the 8x model, higher magnification pulls in greater detail to distant objects. Lightweight, easy to carry and comfortable to hold.

ITEM NO. 2037 UPC 840229103133



MM825 8X25

A mini-porro prism binocular perfect for sporting events, concerts or just taking in the view. Focus once for your eyes and never miss any of the action.

ITEM NO. 2036 UPC 840229103126



Makrolon® Housing

Durable polycarbonate, creates a lightweight, rugged chassis that withstands 11 Gs of impact.



Sports-Auto-Focus™ System

Focus each eyepiece to your vision once, then keeps images razor-sharp from 20 yards to infinity - no more chasing focus on moving targets.



NBR Long Life Rubber Armoring

Durable, shock absorbing rubber that's neither tacky nor spongy. Provides a non-slip grip making it less likely to drop in all weather conditions.

SPECIFICATIONS

MILITARY / MARINE SERIES

	MM1050 10x50	MM750 7x50	MM830 8x30	MM1025 10x25	MM825 8x25
ITEM NUMBER	2035	2038	2033	2037	2036
OBJECTIVE DIAMETER (MM)	50	50	30	25	25
MAGNIFICATION	10x	7x	8x	10x	8x
FIELD OF VIEW AT 1,000 YD. (FT.)	302	387	362	300	360
FOCUSING SYSTEM	Sports-Auto-Focus™	Sports-Auto-Focus™	Sports-Auto-Focus™	Sports-Auto-Focus™	Sports-Auto-Focus™
OPTICS SYSTEM	High Contrast	High Contrast	High Contrast	High Contrast	High Contrast
CLOSE FOCUS (FT.)	66	65	66	66	66
EXIT PUPIL (MM)	5	7.1	3.8	2.5	3.125
LUMINOSITY	25	51.0	14.1	6.25	9.77
TWILIGHT FACTOR	22.4	18.7	15.5	15.81	14.14
COMPASS	-	-	-	-	-
EYECUPS	Cylindrical	Cylindrical	Cylindrical	Ergonomic	Ergonomic
RUBBER ARMORING	NBR Long Life	NBR Long Life	NBR Long Life	NBR Long Life	NBR Long Life
WATERPROOF	Yes	Yes	Yes	Yes	Yes
WEIGHT (OZ.)	35.3	36	17.1	10.65	10.58
DIMENSIONS (IN.) (HxWxD)	5 x 8.1 x 3	6 x 8 x 2.75	4.2 x 6.7 x 2.2	3.7 x 5.6 x 1.8	3.7 x 5.6 x 1.8
NECK STRAP	Comfort	Standard	Comfort	Standard	Standard
NECK STRAP ATTACHMENT	Standard	Standard	Standard	Standard	Standard
OBJECTIVE COVER	Yes	Yes	Yes	Yes	Yes
RAIN PROTECTION CAP	Yes	Yes	Yes	Yes	Yes
CARRY CASE	Yes	Yes	Yes	Yes	Yes
WARRANTY	Heritage™ Warranty	Heritage™ Warranty	Heritage™ Warranty	Heritage™ Warranty	Heritage™ Warranty
MSRP PRICE	\$539.99	\$349.99	\$289.99	\$234.99	\$224.99

The Steiner Heritage Warranty means we stand behind our products. Over half a century of building rugged and reliable product for armed forces around the world gives us this confidence.



We will repair or replace your product at no charge to you. It covers all riflescopes and binoculars sold in the US and Canada for the life of the product.

See full warranty details at www.steineroptics.com/product-warranties

- No warranty card needed.
- No receipt required.
- Warranty is fully transferable to future owners of the product.
- Electronic components are covered by a 3-year warranty.

STEINER 
Nothing Escapes You



T-SERIES



THE BEST
PROUDLY
SERVING
THE FINEST.

UNFAILINGLY RELIABLE
TACTICAL BINOCULARS
FIELD-PROVEN TO
DELIVER BRIGHT,
ACCURATE IMAGES IN
ANY SITUATION. WHEN
LIVES ARE ON THE
LINE, THESE ARE ON
THE SCENE.

**T-SERIES
OVERALL FEATURES**

- COMPACT, LIGHTWEIGHT & STREAMLINED
- HIGH-DEFINITION OPTICS
- FOGPROOF & WATERPROOF DOWN TO 16 FT.
- SHOCKPROOF
- CLICLOC® SYSTEM

10X42r T1042r 10X42r

Features the SUMR targeting reticle system, for a small, light binocular in a power to match newer 10x rifle scopes.

ITEM NO. 2006 UPC 000381865083



10X42 T1042 10X42

10x power and bright image perfect for sniper/spotters, border surveillance, patrol car optics, and tactical ops day and night.

ITEM NO. 2005 UPC 000381865069



10X28 T1028 10X28

10x magnification for more power and performance without sacrificing weight or adding bulk to your field gear.

ITEM NO. 2004 UPC 000381865045



8X24 T824 8X24

Just 12.6 ounces and incredibly compact, with 8x magnification and wide field of view. Perfect for the gear bag.

ITEM NO. 2003 UPC 000381865021



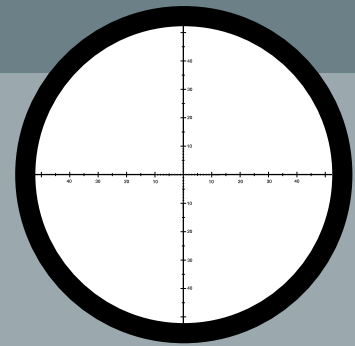

Military Grade Rubber Armoring
Protects chassis and lenses, reduces noise and provides a sure grip in all conditions.

Fast-Close-Focus™
Requires less rotation for quick, clear images from close-up to infinity.

SUMR Reticle

SPECIFICATIONS

T SERIES

	T824 8x24	T1028 10x28	T1042 10x42	T1042r 10x42r
ITEM NUMBER	2003	2004	2005	2006
OBJECTIVE DIAMETER (MM)	24	28	42	42
MAGNIFICATION	8x	10x	10x	10x
FIELD OF VIEW AT 1,000 YD. (FT.)	344	266	317	317
FOCUSING SYSTEM	Fast-Close-Focus™	Fast-Close-Focus™	Fast-Close-Focus™	Fast-Close-Focus™
OPTICS SYSTEM	High Definition Tactical Optic	High Definition Tactical Optic	High Definition Tactical Optic	High Definition Tactical Optic
CLOSE FOCUS (FT.)	6	6	6	6
EXIT PUPIL (MM)	3	2.8	4.2	4.2
LUMINOSITY	6.8	7.1	17.6	17.6
TWILIGHT FACTOR	16.1	17.1	20.5	20.5
COMPASS	-	-	-	-
EYECUPS	Ergonomic	Ergonomic	Ergonomic	Ergonomic
RUBBER ARMORING	NBR Long Life	NBR Long Life	NBR Long Life	NBR Long Life
WATERPROOF	Submersion to 6 ft.	Submersion to 6 ft.	Submersion to 6 ft.	Submersion to 6 ft.
WEIGHT (OZ.)	12.6	12.7	26.4	26.7
DIMENSIONS (IN.) (HxWxD)	4.8 x 4.2 x 1.9	5.1 x 4.6 x 1.9	6.6 x 4.9 x 2.5	6.6 x 4.9 x 2.5
NECK STRAP	Neoprene	Neoprene	Neoprene	Neoprene
NECK STRAP ATTACHMENT	ClicLoc®	ClicLoc®	ClicLoc®	ClicLoc®
OBJECTIVE COVER	Yes	Yes	Yes	Yes
RAIN PROTECTION CAP	Yes	Yes	Yes	Yes
CARRY CASE	Gear Bag	Gear Bag	Gear Bag	Gear Bag
WARRANTY	Heritage™ Warranty	Heritage™ Warranty	Heritage™ Warranty	Heritage™ Warranty
MSRP PRICE	\$319.99	\$349.99	\$529.99	\$759.99

The Steiner Heritage Warranty means we stand behind our products. Over half a century of building rugged and reliable product for armed forces around the world gives us this confidence.



We will repair or replace your product at no charge to you. It covers all riflescopes and binoculars sold in the US and Canada for the life of the product.

See full warranty details at www.steineroptics.com/product-warranties

- No warranty card needed.
- No receipt required.
- Warranty is fully transferable to future owners of the product.
- Electronic components are covered by a 3-year warranty.

M-SERIES



**ELITE UNITS
WORLDWIDE
RELY ON THEM.
SO CAN YOU.**

**BUILT WITH MILITARY-
GRADE PRECISION
AND OPTICAL
QUALITY. PROVEN
IN EVERY THEATER,
THESE ARE THE
BINOCULARS YOU
WANT WITH YOU WHEN
VISUAL SUPERIORITY
IS MISSION-CRITICAL.**

M-SERIES OVERALL FEATURES

- MIL-SPEC
- FLOATING PRISM SYSTEM
- MULTI-COATED LENSES
- MAKROLON® HOUSING
- SPORTS-AUTO-FOCUS™ SYSTEM
- RANGING RETICLE
- CYLINDRICAL EYECUPS
- FOGPROOF & WATERPROOF DOWN TO 16 FT.
- SHOCKPROOF
- LE, MILITARY & GOVERNMENT SALES ONLY



M1050r/LPF 10x50r

Ideal for open terrain and mountainous or hilly country. Equipped with a milliradian ranging reticle.

ITEM NO. 2663 (SUMR) UPC 840229102167
*ITEM NO. 2664 (SUMR) LPF GEN II UPC 840229102433
*ITEM NO. 2665 (SUMR) LPF GEN III UPC 840229102822



M750rc 7x50rc

Integrates bright image, illuminated HD stabilized compass, and milliradian ranging reticle, giving you the ability to accurately identify targets and determine bearings and distance to the single degree.

ITEM NO. 2690 UPC 840229102259



M750r 7x50r

Offers exceptionally bright images in all light conditions, especially useful for nighttime ops. Crisp resolution and a wide field of view help you locate and identify targets faster and more accurately.

ITEM NO. 2650 UPC 840229102105
*M750r LPF (GEN II) ITEM NO. 2651 UPC 840229102112
*M750r LPF (GEN III) ITEM NO. 2652 UPC 840229102129



M830r 8x30r

Light and easy to handle, with high-definition lenses for bright images and a wide field of view for steady viewing, even on moving vehicles. Includes a precision milliradian ranging reticle.

ITEM NO. 2640 UPC 840229102075

M1580 15x80

High magnification and large, precise lenses to observe objects several miles away with astounding detail, even in low light.



ITEM NO. 2670
UPC
840229102174

M1580rc 15x80c

Integrates a large, illuminated HD stabilized compass for accurate bearings, fluid damped to eliminate degree variance while moving in a vehicle or ship.



ITEM NO. 2693
UPC
840229102280

M2080 20x80

All the features of the 15x80 with even higher magnification for greater range without sacrificing the field of view. Excellent for border observation, airports and airspace monitoring.



ITEM NO. 2675
UPC
840229102198



Shockproof Lens and Prisms

Built into unbreakable binocular housings, then purged, sealed and shielded to withstand harsh conditions.

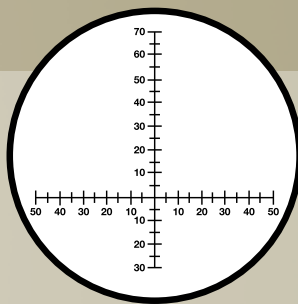

Mil Ranging Reticle

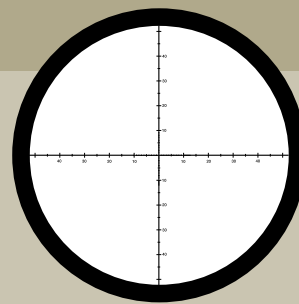

SUMR Reticle

SPECIFICATIONS

M SERIES

	M30r 8x30r	M750rc 7x50rc	M1050r 10x50r/LPF	M750r LPF 7x50r/LPF	M1580 15x80	M1580c 15x80c	M2080 20x80
ITEM NUMBER	2640*	2690	2663 / 2664* / 2665*	2650*/2651* / 2652*	2670	2693	2675
OBJECTIVE DIAMETER (MM)	30	50	50	50	80	80	80
MAGNIFICATION	8x	7x	10x	7x	15x	15x	20x
FIELD OF VIEW AT 1,000 YD. (FT.)	392	392	318	392	195	301	195
FOCUSING SYSTEM	Sports-Auto-Focus™	Sports-Auto-Focus™	Sports-Auto-Focus™	Sports-Auto-Focus™	Sports-Auto-Focus™	Sports-Auto-Focus™	Sports-Auto-Focus™
OPTICS SYSTEM	Fully Multi-Coated	Fully Multi-Coated	Fully Multi-Coated	Fully Multi-Coated	Fully Multi-Coated	Fully Multi-Coated	Fully Multi-Coated
CLOSE FOCUS (FT.)	66	66	66	66	197	197	197
EXIT PUPIL (MM)	3.8	7.1	5	7.1	5.3	5.3	4
LUMINOSITY	14	51	25	51	28	28	16
TWILIGHT FACTOR	15.5	18.7	22.4	18.7	34.6	34.6	40
COMPASS	-	HD Stabilized	-	-	-	HD Stabilized	-
EYECUPS	Cylindrical	Cylindrical	Cylindrical	Cylindrical	Cylindrical	Cylindrical	Cylindrical
RUBBER ARMORING	NBR Long Life	NBR Long Life	NBR Long Life	NBR Long Life	NBR Long Life	NBR Long Life	NBR Long Life
WATERPROOF	Submersion to 16 ft.	Submersion to 16 ft.	Submersion to 16 ft.	Submersion to 16 ft.	Submersion to 16 ft.	Submersion to 16 ft.	Submersion to 16 ft.
WEIGHT (OZ.)	18.7	39.7	35.3	36.9	68.1	69.3	68.1
DIMENSIONS (IN.) (HxWxD)	4.2 x 6.7 x 2.2	5.5 x 8.1 x 3.7	5 x 8.1 x 3	5.5 x 8.1 x 3	11.6 x 8.9 x 3.8	11.6 x 8.9 x 4.1	11.6 x 8.9 x 3.8
NECK STRAP	Yes	Yes	Yes	Yes	Yes	Yes	Yes
NECK STRAP ATTACHMENT	Standard	Standard	Standard	Standard	Standard	Standard	Standard
OBJECTIVE COVER	Yes	Yes	Yes	Yes	Yes	Yes	Yes
RAIN PROTECTION CAP	Yes	Yes	Yes	Yes	Yes	Yes	Yes
BATTERY	-	1.5 V 350	-	-	-	1.5 V 350	-
SPECIAL FEATURES	Mil Ranging Reticle, Military Specifications	HD Stabilized Compass, Mil Ranging Reticle, Military Specifications	SUMR Milliradian Ranging Reticle, Military Specifications	Mil Ranging Reticle, Laser Protection Filter, Military Specifications	Tripod Mount, Military Specifications	Tripod mount, HD Stabilized Compass, Military Specifications	Tripod Mount, Military Specifications
WARRANTY	Heritage™ Warranty	Heritage™ Warranty	Heritage™ Warranty	Heritage™ Warranty	Heritage™ Warranty	Heritage™ Warranty	Heritage™ Warranty
MSRP PRICE	\$939.99	\$1,259.99	\$ 1,174.99 / \$1,609.99 / \$2,299.99	\$1,114.99 / \$1,494.99 / \$2,184.99	\$1,644.99	\$2,069.99	\$1,739.99

*LE, Military, & Government sales only

We will repair or replace your product at no charge to you. It covers all riflescopes and binoculars sold in the US and Canada for the life of the product.

See full warranty details at www.steineroptics.com/product-warranties

- No warranty card needed. • No receipt required. • Warranty is fully transferable to future owners of the product.
- Electronic components are covered by a 3-year warranty.



STEINER-OPTICS.COM

M-SERIES LRF



**TARGET CLARITY
AND RANGE FOR
THE EDGE IN
ANY ENCOUNTER.**

THE COMBINATION
OF STATE-OF-THE-ART
OPTICS, LEGENDARY
STEINER
RELIABILITY, AND
SPOT-ON LASER
RANGING CAN MAKE A
CRITICAL DIFFERENCE
IN SITUATIONS WHERE
ACCURACY MEANS
EVERYTHING.

**M-SERIES LRF
OVERALL FEATURES**

- MIL-SPEC
- FLOATING PRISM SYSTEM
- ERGONOMIC DESIGN FOR COMFORTABLE OBSERVATION
- BUILT-IN LASER RANGEFINDER
- MAKROLON® HOUSING
- SPORTS-AUTO-FOCUS™ SYSTEM
- FOGPROOF & WATERPROOF DOWN TO 16 FT.
- SHOCKPROOF



M830r LRF 1535NM 8X30r LRF

The M830r LRF 1535nm ranges farther - from 25 to 6,000 meters - using a wavelength invisible to your adversary's night vision devices.

ITEM NO. 2681 UPC 840229102228

Bluetooth Adaptor

Provides Bluetooth capability with compatible devices such as the Kestrel 5700 Elite weather meter with LINK. The adaptor transmits range data to the device to generate an accurate firing solution for the indicated distance.

ITEM NO. 2627 UPC 840229102839



M1050 LRF 10X50 LRF

Features a wide measurement range from 27 yards to over 1,860 yards on reflective targets, plus Scan Mode to measure small or moving targets.

ITEM NO. 2682 UPC 840229102235

M830r LRF 8X30r LRF

Perfect for mobile troops who travel light. Lenses and prisms are combined with state-of-the-art coatings to provide bright, crisp images at any range. Ranges can be set to meters or yards.

ITEM NO. 2680 UPC 840229102211





Bluetooth Adaptor The M830r LRF 1535NM pair with compatible devices such as the Kestrel 5700 elite weather meter with LiNK.



Laser Rangefinding Precise ranging out to 1,860 yd. or 6,000 m. with the 1535NM model. Scan Mode available for moving targets.

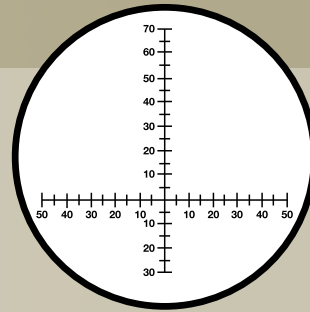

Mil Ranging Reticle

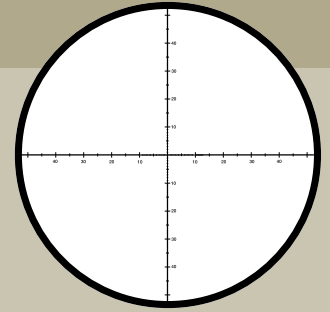

SUMR Reticle

SPECIFICATIONS

	M830r LRF 1535nm	M1050r LRF	M830r LRF
	8x30rLRF*	10x50 LRF	8x30 LRF
ITEM NUMBER	2681	2682	2680
OBJECTIVE DIAMETER (MM)	30	50	30
MAGNIFICATION	8x	10x	8x
FIELD OF VIEW AT 1,000 YD. (FT.)	438	318	319
FOCUSING SYSTEM	Sports-Auto-Focus™	Sports-Auto-Focus™	Sports-Auto-Focus™
OPTICS SYSTEM	Fully Multi-Coated	Fully Multi-Coated	Fully Multi-Coated
CLOSE FOCUS (FT.)	66	66	66
EXIT PUPIL (MM)	3.8	5	3.8
LUMINOSITY	14	25	14
TWILIGHT FACTOR	15.5	22.4	15.5
COMPASS	-	-	-
EYECUPS	Cylindrical	Cylindrical	Cylindrical
RUBBER ARMORING	NBR Long Life	NBR Long Life	NBR Long Life
WATERPROOF	Submersion to 16 ft.	Submersion to 16 ft.	Submersion to 16 ft.
WEIGHT (OZ.)	33	44.8	26.5
DIMENSIONS (IN.) (HxWxD)	4.5 x 6.7 x 2.8	5.4 x 8.1 x 3.9	4.5 x 6.7 x 2.8
NECK STRAP	Yes	Yes	Yes
NECK STRAP ATTACHMENT	Standard	Standard	Standard
OBJECTIVE COVER	Yes	Yes	Yes
RAIN PROTECTION CAP	Yes	Yes	Yes
CARRY CASE	-	-	-
BATTERY	CR2	CR123A	CR2
SPECIAL FEATURES	Tripod Mountable, Mil Ranging Reticle, Military Specifications, Laser Rangefinder Measuring Range: 27 to 6,000 yd.	Tripod Mountable, Military Specifications, Laser Rangefinder Measuring Range: 27 to 1,860 yd.	Tripod Mountable, Mil Ranging Reticle, Military Specifications, Laser Rangefinder Measuring Range: 27 to 1,860 yd.
WARRANTY	Heritage™ Warranty	Heritage™ Warranty	Heritage™ Warranty
MSRP PRICE	\$9,199.99*	\$3,449.99	\$2,589.99

	Bluetooth Adaptor
ITEM NUMBER	2627
HEIGHT	34.5 mm
WIDTH	26.7 mm
DEPTH	17.2 mm
WEIGHT	10 g
OPERATING TEMPERATURE	-20° / +50°C
STORAGE TEMPERATURE	-40° / +80°C
WATER-PRESSURE-PROOFNESS	5 m
BLUETOOTH VERSION	4.1
INTERFACE	ODU mini-snap plug
RANGE	5 m
WARRANTY	Heritage™ Warranty
MSRP PRICE	\$494.99

The Steiner Heritage Warranty means we stand behind our products. Over half a century of building rugged and reliable product for armed forces around the world gives us this confidence.

We will repair or replace your product at no charge to you. It covers all riflescopes and binoculars sold in the US and Canada for the life of the product.

See full warranty details at www.steineroptics.com/product-warranties

- No warranty card needed.
- No receipt required.
- Warranty is fully transferable to future owners of the product.
- Electronic components are covered by a 3-year warranty.



STEINER 
Nothing Escapes You





STEINER EOPTICS



DBAL & SBAL | 70
TOR SERIES | 72
DUAL BEAM AIMING LASERS | 74
CLOSE QUARTER BATTLE SIGHTS | 78
BATTLE LIGHTS | 80
ILLUMINATORS | 82

NIGHT VISION | 84
NOVA | 86
NORTH STAR | 87
MCID | 88
STAR BEACON | 89
AIRFIELD BEACON | 90

eOptics Technology

Steiner eOptics products utilize innovative state-of-the-art technologies that make you more effective in the field and provide a higher level of performance, even in the harshest of environments. You can let your instincts and training take over and still be confident, accurate and highly effective.



FEATURES:



STATE-OF-THE-ART ENGINEERING DEPARTMENT

Steiner eOptics maintains a cutting-edge engineering department with a full complement of experienced mechanical, electrical and optical engineers. These professionals are supported by highly skilled electrical and mechanical technicians.

RAPID PROTOTYPING

Once the initial design process is finished, rapid 3-D printing stations are used to prototype and perfect the design. We have access to suppliers and resources to quickly take a design project from bare concept to a working, testable prototype.

ASSEMBLY

Once parts are received, the design team is able to assemble and test laser and illumination systems in a state-of-the-art eOptics lab.

QUALITY ASSURANCE

Steiner eOptics maintains an ISO 9001:2008 Quality Management System and has continuously maintained an ISO 9001 QMS certification since 2001. Quality plays a very important role at Steiner and starts with the design and development process. During the initial design review, our engineers evaluate their design concept to make sure that it will meet the necessary quality requirements.



A PROVEN TRACK RECORD

Steiner eOptics has a proven track record as a government contractor supplying military lasers and lights to the U.S. Department of Defense as well as to NATO customers. In addition to supplying products to our military customer, Steiner eOptics has also been selected to provide design and development services by the U.S. Government and other prime contractors.



KEY TEST AND ASSEMBLY CAPABILITIES

- A Class 100 clean room for the assembly of sensitive optics products
- Sensitive optical power meters and beam characterization cameras with the necessary filters and apertures for measuring all laser outputs from 500 nm to 1.5 microns at output powers from .01 mW to 500 mJ
- Laser safety room with controlled access and safety shielding to accommodate high-energy lasers to 500 mJ
- A full array of environmental test equipment



PRODUCTION PROCESS

The production process ensures that any defects in assembly are caught as early as possible. The majority of the assembly stages also have a matching test stage used to confirm that the prior production step was properly performed.

RIGOROUS TESTING PROCESSES

MECHANICAL SHOCK, TO SIMULATE THE WEAPONS ON WHICH THE DEVICES WILL BE MOUNTED



MECHANICAL VIBRATION, TO SIMULATE TRANSPORT ON MILITARY AND COMMERCIAL VEHICLES INCLUDING ROTARY-WING AND FIXED-WING AIRCRAFT



HIGH AND LOW TEMPERATURE OPERATION AND STORAGE TESTING, WHERE THE DEVICES ARE EXPOSED TO THE MAXIMUM EXPECTED OPERATING TEMPERATURES AND STORAGE TEMPERATURES

TEMPERATURE SHOCK, WHERE THE EQUIPMENT IS HEATED TO A HIGH TEMPERATURE AND TRANSITIONED INTO A VERY COLD TEMPERATURE WITHIN A FEW SECONDS



IMMERSION TESTING, BOTH SIMULATED AND TO ACTUAL DEPTHS AS FAR AS 66 METERS



ADDITIONAL ENVIRONMENTAL TESTING MAY INCLUDE EXPOSURE TO SALT FOG, SAND, OR DUST AND ELECTRO-MAGNETIC SHOCK TESTING



DBAL/SBAL LASER SERIES



CREATE THE
ADVANTAGE.
CONTROL
THE OUTCOME.

IN A STRESSFUL, LIFE-THREATENING SITUATION, HAVING THE RIGHT EQUIPMENT CAN MEAN THE DIFFERENCE BETWEEN SUCCESS AND FAILURE. THE STEINER DBAL/SBAL SERIES LASERS PROVIDE WHAT YOU NEED TO GET THE JOB DONE.

PISTOL LIGHT LASERS OVERALL FEATURES

- FULLY ADJUSTABLE WINDAGE/ ELEVATION
- INTEGRATED PICATINNY MOUNT
- QUICK RELEASE BATTERY LATCH
- PROGRAMMABLE SWITCH FUNCTIONS FOR SINGLE TAP, DOUBLE TAP, AND PRESS AND HOLD OPERATION.

DBAL SPECIFIC

- VISIBLE GREEN LASER, IR LASER & IR ILLUMINATOR & WHITE LIGHT LED
- CO-ALIGNED VISIBLE & IR AIMING LASERS
- POWERED BY TWO CR123A BATTERIES

SBAL SPECIFIC

- VISIBLE GREEN LASER & WHITE LIGHT LED
- POWERED BY ONE CR123A BATTERY

SBAL-RL SINGLE BEAM AIMING LASER RIFLE LIGHT



SBAL-RL v2 ITEM NO. 9026 UPC 000381890269

Visible Laser	White Light
<5 mW green laser Class IIIa	500 lumens

DBAL-RL DUAL BEAM AIMING LASER RIFLE LIGHT



DBAL-RL v2 ITEM NO. 9027 UPC 000381890276

Visible Laser	IR Pointer	IR LED Illuminator	White Light
<5 mW green laser Class IIIa	<.7 mW	600 mW	400 lumens





Push Button Mode Selection

Includes fully programmable switch functions for single tap, double tap, and press and hold operation.



Adjustable Mounting Bracket

Easily attaches the DBAL-PL/RL and SBAL-PL/RL to standard pistol rails or M1913 Picatinny rails



Bright White Light

(and the IR pointer on the DBAL-PL)
Sits below the visible green laser.
Recoil-resistant LEDs ensure reliable performance shot after shot.

SPECIFICATIONS

	SBAL-RL 9026	DBAL-RL 9027
LASER TYPE	VISIBLE RED OR GREEN	Green - Class IIIa
	IR LASER POINTER	Class I
	IR LED ILLUMINATOR	Eye-Safe
POWER OUTPUT	VISIBLE RED / GREEN LASER	<5 mW
	IR LASER POINTER	<0.7 mW
	IR ILLUMINATOR	<600 mW
	WHITE LIGHT	500 lumens
WAVELENGTH	VISIBLE RED LASER	-
	VISIBLE GREEN LASER	520 nm
	IR LASER POINTER	850 nm
	IR LASER ILLUMINATOR	850 nm
PEAK ILLUMINANCE	WHITE LIGHT	Lumens/m ² @ 5m = 115 lux
BEAM DIVERGENCE	VISIBLE LASER	<0.8 mRad
	IR LASER POINTER	<0.8 mRad
	IR LED ILLUMINATOR	18°
	WHITE LIGHT	22°
RANGE/VISIBILITY (NIGHT/DAY)* <small>RANGE MAY VARY DEPENDING ON LIGHT CONDITIONS</small>	VISIBLE RED LASER	-
	VISIBLE GREEN LASER	750 m / 15 m
	IR LASER POINTER	>250 m
	IR LED ILLUMINATOR	>250 m
	WHITE LIGHT	>100 m
TEMPERATURE	BATTERY	-20° C to +65° C
	BATTERY	CR123A (1)
BATTERY LIFE (MODE DEPENDENT)	BATTERY	CR123A (2)
	BATTERY LIFE (MODE DEPENDENT)	1.75 Hours
MATERIAL	MATERIAL	1.75 Hours
	MATERIAL	Aircraft Aluminum
COLOR	COLOR	Aircraft Aluminum
	COLOR	Black
WEIGHT (WITH BATTERY) (OZ.)	WEIGHT (WITH BATTERY) (OZ.)	4.6
	WEIGHT (WITH BATTERY) (OZ.)	4.6
DIMENSIONS (IN.) (LxWxH)	DIMENSIONS (IN.) (LxWxH)	3.5 x1.3 x1.4
	DIMENSIONS (IN.) (LxWxH)	3.46 x 1.3 x 1.4
WATERPROOF	WATERPROOF	Submersible to 5 m
	WATERPROOF	Submersible to 5 m
MOUNT	MOUNT	Standard Pistol or M1913 Rails
	MOUNT	Standard Pistol or M1913 Rails
WINDAGE & ELEVATION ADJUSTMENT	WINDAGE & ELEVATION ADJUSTMENT	Yes
	WINDAGE & ELEVATION ADJUSTMENT	Yes
ACTIVATION SWITCH	ACTIVATION SWITCH	Remote Cable
	ACTIVATION SWITCH	Remote Cable
REMOTE CABLE PRESSURE PAD	REMOTE CABLE PRESSURE PAD	-
	REMOTE CABLE PRESSURE PAD	Yes
WARRANTY	WARRANTY	2-Year
	WARRANTY	2-Year
MSRP PRICE	MSRP PRICE	\$1,114.99
	MSRP PRICE	\$1,494.99

STEINER EOPTICS 2-YEAR WARRANTY

eOptics warrants its products against defects in workmanship and materials for a period of 2 years from the date of purchase.

The warranty covers all Night Vision Devices, Laser Aiming Solutions, Beacons and Battle Lights. Valid in U.S. and Canada only.

For complete warranty information go to www.steiner-optics.com/product-warranties

TOR SERIES NEW



**BATTLE
HARDENED.
CIVILIAN
READY.**

COMBAT-WORTHY
LIGHTS AND LASERS,
MIL-GRADE ALUMINUM,
BUILT STEINER
STRONG. DESIGNED
TO EXPOSE, BLIND,
AND TARGET WITH
MAXIMUM IMPACT. UP
TO ANY CHALLENGE.
JUST LIKE YOU.

**TOR SERIES
OVERALL FEATURES**

- ANODIZED ALUMINUM HOUSING
- ADJUSTABLE FOR WINDAGE/ELEVATION
- UNIVERSAL RAIL MOUNT

Combines white light illumination with either a red or green aiming laser. Fits all pistols with a Picatinny or Weaver rail.

NEW ITEM NO. 7001 | GREEN LASER UPC 000381870018
NEW ITEM NO. 7005 | RED LASER UPC 000381870056

TOR FUSION



A high-powered white light LED illuminator with universal rail mount.

NEW ITEM NO. 7002 | 350 LUMEN UPC 000381870025

TOR TORCH



Miniature rail-mounted laser available with either red or green lasers. Fits all pistols with a Picatinny or Weaver rail.

NEW ITEM NO. 7003 | GREEN LASER UPC 000381870032
NEW ITEM NO. 7006 | RED LASER UPC 000381870063

TOR MINI



A sub-miniature rail mounted aiming laser for pistols. Available with green or red laser.

NEW ITEM NO. 7004 | GREEN LASER UPC 000381870049
NEW ITEM NO. 7007 | RED LASER UPC 000381870070

TOR MICRO





TOR Micro and Mini

Left and right fire buttons for ambidextrous use. Green and red lasers are cold weather capable.



TOR Torch

An internal sensor turns on the light when drawn from a holster and turns off when put back in holster or set on its side.



TOR Fusion

Combines Auto-On with Boost Mode that turns on both the laser and illuminator to maximum power for 60 seconds.

SPECIFICATIONS

TOR SERIES

	TOR Fusion	TOR Torch	TOR Mini	TOR Micro
ITEM NUMBER	7001/7005	7002	7003/7006	7004/7007
MAX LASER POWER	5.0 mW	-	5.0 mW	12 mW
MAX CONTINUOUS ILLUMINATOR POWER	350 lumen	350 lumen	-	-
BOOST MODE ILLUMINATOR POWER	470 lumen	-	-	-
LENGTH (IN.)	2.70 (685.6 mm)	2.70 (685.6 mm)	2.19 (55.6 mm)	1.83 (46.4 mm)
WIDTH (IN.)	1.34 (34 mm)	1.34 (34 mm)	1.26 (32 mm)	1.02 (25.9 mm)
HEIGHT (IN.)	1.39 (35.4 mm)	1.39 (35.4 mm)	1.17 (29.8 mm)	1.06 (27 mm)
BATTERY	CR123	CR123	CR 1/3M	(6) AG4 silver oxide
CLASS	3R Laser	-	3R Laser	3R Laser
WARRANTY	2-Year Warranty	2-Year Warranty	2-Year Warranty	2-Year Warranty
MSRP PRICE	Please Call	Please Call	Please Call	Please Call

STEINER 2-YEAR WARRANTY

eOptics warrants its products against defects in workmanship and materials for a period of 2 years from the date of purchase.

The warranty covers all Night Vision Devices, Laser Aiming Solutions, Beacons and Battle Lights. Valid in U.S. and Canada only.

For complete warranty information go to www.steiner-optics.com/product-warranties



DUAL BEAM AIMING LASERS



NO CHALLENGE TOO TOUGH. NO SITUATION TOO DARK.

UNMATCHED VERSATILITY AND SUPERIOR OPERATIONAL LONGEVITY ARE PAIRED IN THE DBAL FAMILY OF LASERS TO PROVIDE MAXIMUM FUNCTIONALITY FOR MILITARY, LAW ENFORCEMENT AND SELF-DEFENSE USERS WORLDWIDE.

DUAL BEAM AIMING LASERS OVERALL FEATURES

- FULLY ADJUSTABLE WINDAGE & ELEVATION
- HIGH & LOW POWER MODES
- INCLUDES REMOTE CABLE PORT
- ACTIVATION/LOW BATTERY INDICATOR LIGHT



DBAL SERIES DBAL-A³

CIVILIAN DUAL BEAM AIMING LASER - ADVANCED³
Now available for the commercial market. Features an adjustable IR illuminator for better illumination at longer ranges, dual activation switches and high/low power modes.

ITEM NO. 9008-BLACK UPC 000381890085
9009-DESERT SAND UPC 000381890092

Visible Laser	IR Pointer	IR Illuminator
<5 mW green laser	<.7 mW	<4 mW

• VISIBLE GREEN LASER • IR LASER & ILLUMINATOR COMBINED

RESTRICTED ITEM NO. 10010-BLACK

Visible Laser	IR Pointer	IR Illuminator
<50 mW green laser	50 mW	50 mW

RESTRICTED ITEM NO. 10011-BLACK

Visible Laser	IR Pointer	IR Illuminator
<80 mW red laser	50 mW	50 mW

DBAL SERIES DBAL-A⁴

DUAL BEAM AIMING LASER - ADVANCED⁴
New advanced DBAL-A4 with four functionalities: visible green light, IR Laser, IR Illuminator, and white light. High/low modes. Civilian and restricted models available.

ITEM NO. 9014 -BLACK UPC 000381890146
ITEM NO. 9016 - DESERT SAND UPC 000381890153

Visible Laser	IR Pointer	IR Illum.	White Light
5 mW green laser	.7 mW	600 mW	500 Lumens
5 mW green laser	.7 mW	600 mW	500 Lumens

ITEM NO. 9032 -BLACK UPC 000381890320
ITEM NO. 9033 - DESERT SAND UPC 000381890337

Visible Laser	IR Pointer	IR LED Illum.	White Light
<5 mW red laser	<.7 mW	110/330 mW	500 Lumens
<5 mW red laser	<.7 mW	110/330 mW	500 Lumens





Push-Button Activation

Remote cable- pressure-pad switch activation; tap and release for momentary activation; tap twice for 5-minute continuous ON.



Quick Release HT Mount

Self-adjusting mount attaches to any Picatinny rail.



Dual Remote Activation Ports

Provides visible override.

SPECIFICATIONS

	DBAL-A ³ 9008	DBAL-A ³ 9009	DBAL-A ³ 10010* / 10010D*	DBAL-A ³ 10011* / 10011D*	DBAL-A ⁴ 9014 / 9016	DBAL-A ⁴ 9032 / 9033	
LASER TYPE	VISIBLE RED OR GREEN IR LASER POINTER IR LASER ILLUMINATOR	Green - Class IIIa IR - Class I IR - Class 3r	Green - Class IIIa IR - Class I IR - Class 3r	Green - Class IIIa IR - Class IIIb IR-Class IIIb	Red - Class IIIa IR - Class IIIb IR-Class IIIb	Green - Class IIIa IR - Class I -	Red - Class 3R IR - Class I -
POWER OUTPUT	VISIBLE RED / GREEN LASER IR LASER POINTER IR LASER ILLUMINATOR WHITE LIGHT	<5 mW <0.7 mW <4.0 mW -	<5 mW <0.7 mW <4.0 mW -	<50 mW 50 mW 50 mW -	<80 mW 50 mW 50 mW -	5 mW .7 mW 600mW 500 Lumens	<5 mW <.7 mW 110/330mW 500 Lumens
WAVELENGTH	VISIBLE RED LASER VISIBLE GREEN LASER IR LASER POINTER IR LASER ILLUMINATOR	- 532 nm 850 nm 835 nm	- 532 nm 850 nm 835 nm	- 532 nm 835 nm 835 nm	- - 825-855 nm 850 nm	- - 825-855 nm 850nm	635-650mW - 825-855 nm 850nm
BEAM DIVERGENCE	VISIBLE LASER IR LASER POINTER IR LASER ILLUMINATOR WHITE LIGHT	<0.8 mRad <0.8 mRad 95 to 195mRad -	<0.8 mRad <0.8 mRad 95 to 195mRad -	<0.8 mRad <0.8 mRad 1.5 to 195mRad -	<0.8 mRad <0.8 mRad 1.5 to 195mRad -	<0.5 mRad <0.5 mRad 4°/90° 8°	<0.5 mRad <0.5 mRad 4°/90° 8°
RANGE/VISIBILITY (NIGHT/DAY)* <small>RANGE MAY VARY DEPENDING ON LIGHT CONDITIONS.</small>	VISIBLE RED LASER VISIBLE GREEN LASER IR LASER POINTER IR LASER ILLUMINATOR WHITE LIGHT	- 750 m / 15m >250 m >175m -	- 750 m / 15m >250 m >175m -	- 1750 m / 75m 1000 m >2500 m -	1750 m / 75m - 1000 m 1000 m -	- >2000 m / >50m >3600 m / NA >2000 m / NA <600 m	>2000 m / >50 m - >3600 m / NA >2000 m / NA <600 m
TEMPERATURE	5° C to +55° C	5° C to +55° C	5° C to +65° C	-40° C to +55° C	-20° to +65° C	-20° to +65° C	
BATTERY	CR123A	CR123A	CR123A	CR123A	2x CR123A	2x CR123A	
BATTERY LIFE (MODE DEPENDENT)	> 3 Hours	> 3 Hours	> 3 Hours	> 3 Hours	> 3 Hours	> 3 Hours	
MATERIAL	Aircraft Aluminum	Aircraft Aluminum	Aircraft Aluminum	Aircraft Aluminum	Aircraft Aluminum	Aircraft Aluminum	
COLOR	Black	Desert Sand	Black / Desert Sand	Black / Desert Sand	Black / Desert Sand	Black / Desert Sand	
WEIGHT (WITH BATTERY) (OZ.)	8	8	8	8	12	12	
DIMENSIONS (IN.) (LxWxH)	3.5 x 2.75 x 1.59	3.5 x 2.75 x 1.59	3.5 x 2.75 x 1.59	3.5 x 2.75 x 1.59	4.5 x 3.4 x 2.1	4.5 x 3.2 x 2.1	
WATERPROOF	Submersible to 5 m	Submersible to 5 m	Submersible to 5 m	Submersible to 5 m	Submersible to 5 m	Submersible to 5 m	
MOUNT	QD HT Mount	QD HT Mount	QD HT Mount	QD HT Mount	QD HT Mount	QD HT Mount	
WINDAGE & ELEVATION ADJUSTMENT	Yes	Yes	Yes	Yes	Yes	Yes	
ACTIVATION SWITCH	Integrated Push Button	Integrated Push Button	Integrated Push Button	Integrated Push Button	Integrated Push Button	Integrated Push Button	
REMOTE CABLE PRESSURE PAD	Yes	Yes	Yes	Yes	Yes	Two Included	
WARRANTY	2-Year	2-Year	2-Year	2-Year	2-Year	2-Year	
MSRP PRICE	\$1,534.99	\$1,534.99	\$2,789.99*	\$2,099.99*	\$2,929.99 / \$2,989.99	\$2,874.99 / \$2,929.99	

*Restricted to LE/Military only. Contact Steiner directly for quote and availability.

STEINER OPTICS 2-YEAR WARRANTY

eOptics warrants its products against defects in workmanship and materials for a period of 2 years from the date of purchase. The warranty covers all Night Vision Devices, Laser Aiming Solutions, Beacons and Battle Lights. Valid in U.S. and Canada only.

For complete warranty information go to www.steiner-optics.com/product-warranties

DUAL BEAM AIMING LASERS



**OWN THE NIGHT.
SIEZE THE DAY.**

DBAL SERIES LASERS PROVIDE A TACTICAL ADVANTAGE ON THE BATTLEFIELD, ESPECIALLY WHEN DAY TURNS TO NIGHT. RUGGED, RELIABLE AND EASY TO OPERATE, GIVE YOURSELF THE ADVANTAGE.

DBAL SERIES DBAL-D²

DUAL BEAM AIMING LASER WITH IR LED ILLUMINATOR

High-definition aspherical, telescopic IR LED illuminator significantly enhances night-vision performance. Features a 2° to 30° adjustable illumination flood and offers an eye-safe means of illuminating distances greater than 1,000 meters.



ITEM NO. 9001-BLACK UPC 000381890016
ITEM NO. 9002-DESERT SAND UPC 000381890023

Visible Laser	IR Pointer	IR LED Illuminator
<5 mW green laser Class IIIa	<7 mW	600 mW



DBAL SERIES DBAL-I²

DUAL BEAM AIMING LASER - INTELLIGENT²

The most lightweight model in the DBAL Series, this "intelligent" laser provides extreme accuracy in low-light conditions and can be used with night-vision devices.

ITEM NO. 9003-BLACK UPC 000381890030
ITEM NO. 9004-BLACK UPC 000381890047
ITEM NO. 9007-BLACK UPC 000381890078
ITEM NO. 9005-DESERT SAND UPC 000381890054
ITEM NO. 9006-DESERT SAND UPC 000381890061

Visible Laser	IR Pointer	IR Illuminator
<5 mW green laser Class IIIa	<7 mW	-

ITEM NO. 9007 UPC 000381890078

Visible Laser	IR Pointer	IR Illuminator
-	<7 mW	<4 mW

DUAL BEAM AIMING LASERS OVERALL FEATURES

- FULLY ADJUSTABLE WINDAGE & ELEVATION
- HIGH & LOW POWER MODES
- INCLUDES REMOTE CABLE PORT
- ACTIVATION/LOW BATTERY INDICATOR LIGHT





Push-Button Activation

Remote cable-pressure-pad switch activation; tap and release for momentary activation; tap twice for 5-minute continuous ON.



Quick Release HT Mount

Self-adjusting mount attaches to any Picatinny rail.



Low Profile Design

Can be mounted on top or side rails.

SPECIFICATIONS

		DBAL Series						
		DBAL-D ²		DBAL-I ²				
		9001	9002	9003	9004	9005	9006	9007
LASER TYPE	VISIBLE RED OR GREEN	Green - Class IIIa	Green - Class IIIa	Green - Class IIIa	Red - Class IIIa	Red - Class IIIa	Green - Class IIIa	-
	IR LASER POINTER	Class I	Class I	Class I	Class I	Class I	Class I	Class I
	IR LED ILLUMINATOR	exempt	exempt	-	-	-	-	IR Laser - Class 3r
POWER OUTPUT	VISIBLE RED / GREEN LASER	<5 mW	<5 mW	<5 mW	<5 mW	<5 mW	<5 mW	-
	IR LASER POINTER	<0.7 mW	<0.7 mW	<0.7 mW	<0.7 mW	<0.7 mW	<0.7 mW	<0.7 mW
	IR ILLUMINATOR	<600 mW	<600 mW	-	-	-	-	<4 mW
	WHITE LIGHT	-	-	-	-	-	-	-
WAVELENGTH	VISIBLE RED LASER	-	-	-	635 nm	635 nm	-	-
	VISIBLE GREEN LASER	532 nm	532 nm	532 nm	-	-	532 nm	-
	IR LASER POINTER	850 nm	850 nm	850 nm	850 nm	850 nm	850 nm	850 nm
	IR LED ILLUMINATOR	850 nm	850 nm	-	-	-	-	IR Laser - 835 nm
BEAM DIVERGENCE	VISIBLE LASER	<0.8 mRad	<0.8 mRad	<0.8 mRad	<0.8 mRad	<0.8 mRad	<0.8 mRad	-
	IR LASER POINTER	<0.8 mRad	<0.8 mRad	<0.8 mRad	<0.8 mRad	<0.8 mRad	<0.8 mRad	<0.8 mRad
	IR LED ILLUMINATOR	2° to 30°	2° to 30°	-	-	-	-	95-195 mRad
	WHITE LIGHT	-	-	-	-	-	-	-
RANGE/VISIBILITY (NIGHT/DAY)* <small>RANGE MAY VARY DEPENDING ON LIGHT CONDITIONS.</small>	VISIBLE RED LASER	-	-	-	250 m / 5 m	250 m / 5 m	-	-
	VISIBLE GREEN LASER	750 m / 15 m	750 m / 15 m	750 m / 15 m	-	-	750 m / 15 m	-
	IR LASER POINTER	>250 m	>250 m	>250 m	>250 m	>250 m	>250 m	>250 m
	IR LED ILLUMINATOR	≤1000 m	≤1000 m	-	-	-	-	>175 m Laser
	WHITE LIGHT	-	-	-	-	-	-	-
TEMPERATURE	BATTERY	5° C to +65° C	5° C to +65° C	5° C to +65° C	-40° C to +65° C	-40° C to +65° C	5° C to +65° C	-40° C to +65° C
	BATTERY LIFE (MODE DEPENDENT)	CR123A 3 Hours	CR123A 3 Hours	CR123A > 3 Hours	CR123A > 3 Hours	CR123A > 3 Hours	CR123A > 3 Hours	CR123A > 3 Hours
MATERIAL		Aircraft Aluminum	Aircraft Aluminum	Aircraft Aluminum	Aircraft Aluminum	Aircraft Aluminum	Aircraft Aluminum	Aircraft Aluminum
	COLOR	Black	Desert Sand	Black	Black	Desert Sand	Desert Sand	Black
WEIGHT (WITH BATTERY) (OZ.)		12.5	12.5	8	8	8	8	8
DIMENSIONS (IN.) (LxWxH)		3.95 x 3.37 x 1.59	3.95 x 3.37 x 1.59	3.5 x 2.75 x 1.59	3.5 x 2.75 x 1.59	3.5 x 2.75 x 1.59	3.5 x 2.75 x 1.59	3.5 x 2.75 x 1.59
WATERPROOF		Submersible to 5 m	Submersible to 5 m	Submersible to 5 m	Submersible to 5 m	Submersible to 5 m	Submersible to 5 m	Submersible to 5 m
MOUNT		QD HT Mount	QD HT Mount	QD HT Mount	QD HT Mount	QD HT Mount	QD HT Mount	QD HT Mount
WINDAGE & ELEVATION ADJUSTMENT		Yes	Yes	Yes	Yes	Yes	Yes	Yes
ACTIVATION SWITCH		Integrated Push Button	Integrated Push Button	Integrated Push Button	Integrated Push Button	Integrated Push Button	Integrated Push Button	Integrated Push Button
REMOTE CABLE PRESSURE PAD		Yes	Yes	Yes	Yes	Yes	Yes	Yes
WARRANTY		2-Year	2-Year	3-Year	2-Year	2-Year	2-Year	2-Year
MSRP PRICE		\$1,609.99	\$1,644.99	\$1,069.99	\$919.99	\$974.99	\$1,054.99	\$919.99

STEINER OPTICS 2-YEAR WARRANTY

eOptics warrants its products against defects in workmanship and materials for a period of 2 years from the date of purchase. The warranty covers all Night Vision Devices, Laser Aiming Solutions, Beacons and Battle Lights. Valid in U.S. and Canada only.



For complete warranty information go to www.steiner-optics.com/product-warranties

CLOSE QUARTER BATTLE SERIES



GIVE YOURSELF AN UNFAIR ADVANTAGE.

MOST CLOSE-QUARTER BATTLE ENCOUNTERS ARE BETWEEN 3 TO 10 YARDS. THESE LIGHTWEIGHT VISIBLE AND IR LASER SIGHTS DELIVER SPEED, ACCURACY AND GREATER ODDS FOR SUCCESS.



CQBL-1

One of the smallest and most rugged dual-function lasers available, the CQBL-1 is compatible with virtually every submachine gun and short-barrel rifle. Packs the output power needed for use on carbine, rifle and light machine gun systems.

ITEM NO. 9030-BLACK UPC 000381890306
ITEM NO. 9031-DESERT SAND UPC 000381890313

Visible Laser	IR Pointer
<5 mW red laser Class IIIa	<.7 mW

CLOSE QUARTER BATTLE SERIES OVERALL FEATURES

- FULLY ADJUSTABLE WINDAGE & ELEVATION
- PUSH-BUTTON OR REMOTE CABLE PAD ACTIVATION
- INCLUDES REMOTE CABLE PORT
- QUICK, CONVENIENT MOUNTING OPTIONS
- CO-ALIGNED VISIBLE AND IR LASERS
- INTEGRATED PUSH-BUTTON ACTIVATION



OTAL-C

Designed for the M-4 platform, the visible red laser beam on this "classic" model projects around the front sight. It can be mounted in front of scopes, holographic sights, and night-vision devices.

ITEM NO. 9055-BLACK UPC 000381890559

Visible Laser	IR Pointer
<5 mW red laser Class IIIa	-

ITEM NO. 9056-BLACK UPC 000381890566

Visible Laser	IR Pointer
-	<.07 mW





Co-aligned visible and IR lasers
Eliminate the need to sight in each laser individually. Low-profile windage and elevation adjusters ensure a constant zero (CQBL-1 only).

Integrated Push-Button Activation
Remote cable- pressure-pad switch activation; tap and release for momentary activation; tap twice for 5-minute continuous ON.

Fully Adjustable
Windage and elevation are easily adjusted. Can be configured with a visible or IR laser.

SPECIFICATIONS

Close Quarter Battle Lasers Series

	CQBL-1		OTAL-C	OTAL-C IR
	9030	9031	9055	9056
LASER TYPE	VISIBLE RED OR GREEN IR LASER POINTER IR LASER ILLUMINATOR	Red - Class IIIa Class I -	Red - Class IIIa - -	- Class I -
POWER OUTPUT	VISIBLE RED / GREEN LASER IR LASER POINTER IR LASER ILLUMINATOR	<5 mW <0.7 mW -	<5 mW - -	<0.7 mW - -
WAVELENGTH	VISIBLE RED LASER VISIBLE GREEN LASER IR LASER POINTER IR LASER ILLUMINATOR	635 nm - 850 nm -	635 nm - - -	- - 850 nm -
BEAM DIVERGENCE	VISIBLE LASER IR LASER POINTER IR LASER ILLUMINATOR	<0.8 mRad <0.8 mRad -	<0.8 mRad - -	- <0.8 mRad -
RANGE/VISIBILITY (NIGHT/DAY)* <small>RANGE MAY VARY DEPENDING ON LIGHT CONDITIONS.</small>	VISIBLE RED LASER VISIBLE GREEN LASER IR LASER POINTER IR LASER ILLUMINATOR	250 m / 5 m - >250 m -	250 m / 5 m - - -	- - >250 m -
TEMPERATURE	-40° C to +65° C	-40° C to +65° C	-40° C to +65° C	-40° C to +65° C
BATTERY	CR123A	CR123A	AA	AA
BATTERY LIFE (MODE DEPENDENT)	> 3 Hours	> 3 Hours	5 Hours	5 Hours
MATERIAL	Aircraft Aluminum	Aircraft Aluminum	Aircraft Aluminum	Aircraft Aluminum
COLOR	Black	Desert Sand	Black	Black
WEIGHT (WITH BATTERY) (OZ.)	6	6	5.6	5.6
DIMENSIONS (IN.) (LxWxH)	4.0 x 1.5 x 1.1	4.0 x 1.5 x 1.1	2.8 x 1.4 x .75	2.8 x 1.4 x .75
WATERPROOF	Submersible to 20 m	Submersible to 20 m	Submersible to 5 m	Submersible to 5 m
MOUNT	Integrated Picatinny	Integrated Picatinny	QD HT Mount	QD HT Mount
WINDAGE & ELEVATION ADJUSTMENT	Yes	Yes	Yes	Yes
ACTIVATION SWITCH	Integrated Push Button	Integrated Push Button	Integrated Push Button	Integrated Push Button
REMOTE CABLE PRESSURE PAD	Yes	Yes	Yes	Yes
WARRANTY	2-Year	2-Year	2-Year	2-Year
MSRP PRICE	\$974.99	\$1,179.99	\$574.99	\$574.99

**STEINER OPTICS
2-YEAR WARRANTY**

eOptics warrants its products against defects in workmanship and materials for a period of 2 years from the date of purchase. The warranty covers all Night Vision Devices, Laser Aiming Solutions, Beacons and Battle Lights. Valid in U.S. and Canada only.

For complete warranty information go to www.steiner-optics.com/product-warranties

BATTLE LIGHTS



HOW GOOD GUYS BEAT THE DARK SIDE.

WHEN THE SITUATION CALLS FOR ILLUMINATION, THESE BATTLE LIGHTS WILL LIGHT YOUR WAY WITH A BEAM OF LIGHT THAT PROVIDES FOR MINIMAL DIM OR SHADOWED AREAS SO YOU CAN HAVE CONFIDENCE IN ACCURATELY IDENTIFYING YOUR TARGET.

BATTLE LIGHTS OVERALL FEATURES

- HANDHELD OR WEAPON-MOUNTED CAPABILITY
- RECOIL-RESISTANT WHITE LIGHT LED
- ROBUST WATERPROOF CONSTRUCTION
- TEMPERATURE RANGE: -10° C TO +65° C
- FULLY OPERATIONAL FROM 20,000 FEET ABOVE SEA LEVEL TO 66 FEET BELOW THE OCEAN'S SURFACE



Mk4

The modular, low-profile design of this 500-lumen weapon light provides interchangeable switch options and places the light close to the weapon body, nearly eliminating the rifle barrel shadow and enhancing weapon-handling switchology. It can operate on two CR123A batteries or one rechargeable lithium ion

ITEM NO. 9072-BLACK UPC 000381890726

White Light
500 lumens



Mk5

One of the brightest handheld flashlights available today, this powerful light has a 800-lumen white light LED and illuminates up to 400 meters.

ITEM NO. 9073-BLACK UPC 000381890733

White Light
800 lumens



Push-Button Activation Continuous ON. Mk3 features optional strobe mode.



Handheld or Weapon-Mounted Provides for greater versatility.



Recoil-Resistant White Light LED More durability and dependability when you need it most.

SPECIFICATIONS

LAMP

Battle Lights

	Mk4 9072	Mk5 9073
LAMP	White Light LED	White Light LED
POWER OUTPUT (HIGH / LOW)	500 Lumens	800 Lumens
BEAM DIVERGENCE	10°	10°
RANGE (HIGH POWER) <small>RANGE MAY VARY DEPENDING ON LIGHT CONDITIONS.</small>	300 m	500 m
REFLECTION LENS	Total Internal Reflection Lens	High Output Deep Dish
BATTERY	CR123A (2)	CR123A (2)
BATTERY LIFE	1.25 Hours	≥1 Hour
MATERIAL	Aircraft Aluminum	Aircraft Aluminum
COLOR	Black	Black
WEIGHT (WITH BATTERY & MOUNT) (OZ.)	4.9	6.1
DIMENSIONS (IN.) (LxWxH)	6.04 (L)	6.44 (L)
TEMPERATURE RANGE	-40° C to +65° C	-40° C to +65° C
WATERPROOF	Submersible to 5 m	Submersible to 5 m
MOUNT	MIL-STD-1913/ Picatinny rail	MIL-STD-1913/ Picatinny rail
ACTIVATION SWITCH	Integrated Push Button	Integrated Push Button
REMOTE CABLE PRESSURE PAD	Included	Optional
LOW BATTERY INDICATOR	-	-
WARRANTY	Heritage Warranty	Heritage Warranty
SPECIAL FEATURES	Comes with 1913 Mount, Dual-Purpose Tailcap and Remote Pressure Pad / Optional Y-Cable Connects Mk4 to DBAL-A3 Laser	Handheld or Weapon-Mounted with Optional Accessories
MSRP PRICE	\$369.99	\$259.99

STEINER OPTICS 2-YEAR WARRANTY

eOptics warrants its products against defects in workmanship and materials for a period of 2 years from the date of purchase.

The warranty covers all Night Vision Devices, Laser Aiming Solutions, Beacons and Battle Lights. Valid in U.S. and Canada only.

For complete warranty information go to www.steiner-optics.com/product-warranties



ILLUMINATORS



**OWN THE NIGHT
WITH THIS
SPECIAL PURPOSE
INFRARED
ILLUMINATOR.**

WITH A RANGE OF 900 METERS, THE SPIR WILL DETECT AND IDENTIFY THREATS AT GREATER DISTANCES THAN ANY OTHER TACTICAL IR ILLUMINATOR. IT CAN BE HAND-OPERATED OR WEAPON-MOUNTED.



SPIR

This Special Purpose IR LED illuminator is equipped with a high-definition, aspherical telescopic illuminator. It can be used in conjunction with night-vision equipped spotting scopes and deployed as a handheld or weapon-mounted IR illuminator.

ITEM NO. 9070-BLACK UPC 000381890702

Illuminator

IR LED Illuminator <600 mW / <300 mW

Modern-day warfighters disrupt enemy operations by delivering precise, long-range fire on selected targets. Special operations, police and SWAT units protect innocent civilians in residential hostage crises, high-risk search/arrest warrants and other domestic situations.



MBS-AA BORELIGHT

Quality engineered for a flawlessly centered dot every time, this borelight provides a precise, accurate alignment in the field without firing a single round of ammo. Includes a visible red laser and stainless steel bore rods.

ITEM NO. 9090-BLACK UPC 000381890900

Visible Laser

<5 mW red laser Class IIIa





Push-Button Switch and Port
Remote cable pressure pad (SPIR)



Handheld or Weapon-Mounted
For greater versatility it can be deployed as a handheld or weapon-mounted IR illuminator.

SPECIFICATIONS

	SPIR 9070
LIGHT OUTPUT	LIGHT OUTPUT IR LED Illuminator
	POWER OUTPUT (HIGH / LOW) <600 mW / <300 mW
	WAVELENGTH 850 nm
	FDA CLASS Eye-Safe
BEAM DIVERGENCE	2° to 30°
	RANGE (HIGH POWER) 1000 m
LAMP	LAMP -
	POWER OUTPUT (HIGH / LOW) -
	BEAM DIVERGENCE -
	RANGE (HIGH POWER) -
	<small>RANGE MAY VARY DEPENDING ON LIGHT CONDITIONS.</small>
REFLECTION LENS -	
BATTERY	CR123A (2)
	BATTERY LIFE 2 Hours
	MATERIAL High-Impact Polymer
	COLOR Black
	WEIGHT (WITH BATTERY & MOUNT) (OZ.) 6.5
	DIMENSIONS (IN.) (LxWxH) 6.75 x 1.55 x 1.95
	TEMPERATURE RANGE -40° C to +65° C
	WATERPROOF Submersible to 5 m
	MOUNT MIL-STD-1913/ Picatinny rail
	ACTIVATION SWITCH Integrated Push Button
REMOTE CABLE PRESSURE PAD Optional	
LOW BATTERY INDICATOR -	
WARRANTY 2-Year	
SPECIAL FEATURES Includes Weapon Mount	
MSRP PRICE \$799.99	

Illuminators

	MBS-AA Borelight 9090
LASER TYPE	VISIBLE RED OR GREEN Red - Class IIIa
	IR LASER POINTER -
	IR LASER ILLUMINATOR -
POWER OUTPUT	VISIBLE RED / GREEN LASER <5 mW
	IR LASER POINTER -
	IR LASER ILLUMINATOR -
	WHITE LIGHT -
WAVELENGTH	VISIBLE RED LASER 635 nm
	VISIBLE GREEN LASER -
	IR LASER POINTER -
	IR LASER ILLUMINATOR -
BEAM DIVERGENCE	VISIBLE LASER <0.8 mRad
	IR LASER POINTER -
	IR LED ILLUMINATOR -
RANGE/VISIBILITY (NIGHT/DAY)* <small>RANGE MAY VARY DEPENDING ON LIGHT CONDITIONS.</small>	WHITE LIGHT -
	VISIBLE RED LASER 250 m
	VISIBLE GREEN LASER -
	IR LASER POINTER -
TEMPERATURE	IR LASER ILLUMINATOR -
	WHITE LIGHT -
	TEMPERATURE -40° C to +65° C
	BATTERY AA
	BATTERY LIFE (MODE DEPENDENT) 8 Hours
	MATERIAL Aircraft Aluminum
	COLOR Black
	WEIGHT (WITH BATTERY) (OZ.) 5.4
	DIMENSIONS (IN.) (LxWxH) 9.25 (L)
	WATERPROOF Submersible to 3 m
MOUNT Stainless Steel Bore Rod (2)	
WINDAGE & ELEVATION ADJUSTMENT Yes	
ACTIVATION SWITCH Rotary Switch	
REMOTE CABLE PRESSURE PAD Yes	
WARRANTY 2-Year	
MSRP PRICE \$459.99	

STEINER OPTICS 2-YEAR WARRANTY

eOptics warrants its products against defects in workmanship and materials for a period of 2 years from the date of purchase.

The warranty covers all Night Vision Devices, Laser Aiming Solutions, Beacons and Battle Lights. Valid in U.S. and Canada only.

For complete warranty information go to www.steiner-optics.com/product-warranties

NIGHT VISION



**SUPERIOR
AWARENESS
NO MATTER
WHEN OR WHERE.**

OBSERVE, ASSESS,
COMMUNICATE AND
NAVIGATE WITH
THE MOST CAPABLE
BATTLEFIELD IMAGING
SYSTEM EVER
CREATED.



AN/PVS-21

The AN/PVS-21 Low Profile Night Vision Goggle offers sensor Integration, low-profile see-through technology. This versatile design adapts to any mission or environment, whether in the air, on land and in the water.

ITEM NO. 9210 UPC 000381892102

CEHUD CONFORMAL ENHANCED HEADS UP DISPLAY

A lightweight, compact and ruggedized HUD that is day or night capable. Designed for use with the AN/PVS-21 LPNV Goggle, Model 2740 Monocular and Model 2758 Dayviewer. Accepts SVGA/VGA format color video signals or NTSC/PAL black & white video signals. Fingertip adjustment of power, brightness, contrast and diopter adjustment

ITEM NO. 9241 UPC 000381892416



COTM CLIP ON THERMAL MODULE

The COTM injects its thermal imagery directly onto the eyepiece of the AN/PVS-21 LPNVG so the thermal image retains its black and white color for instant spectral-band differentiation by the operator. The COTM can also be used as a full-color capable Heads Up Display. SVGA, VGA, NTSC or PAL external video sources can be optically overlaid onto the I2 night vision scene of the AN/PVS-21 LPNV for greater situational awareness. Functions as a full-color SVGA heads-up display. Instantly switches between internal thermal imagery to external video sources (weapon sight, maps, UAV video feeds, navigation or communications).

ITEM NO. 9240 UPC 000381892409



MODEL 2740 LOW PROFILE NIGHT VISION MONOCULAR

Retains all the core features of the AN/PVS-21 LPNVG while keeping one of the operator's eyes free from other tasks.

ITEM NO. 9211 UPC 000381892119



AN/PVS-21 OVERALL FEATURES

- LOW-PROFILE, SEE-THROUGH TECHNOLOGY
- SEE-THROUGH OPTICS INSTANTLY TRANSITION TO BRIGHT LIGHT
- LARGE, UN-INTENSIFIED FIELD-OF-VIEW FOR IMPROVED DEPTH PERCEPTION AND CQB CAPABILITY
- ELIMINATES VERTIGO AND TUNNEL VISION ASSOCIATED WITH CONVENTIONAL SYSTEMS
- ENHANCED SITUATIONAL AWARENESS WITH SENSOR INTEGRATION



Rugged Design

Ideal for high-speed vehicle operation, parachute jumps and aggressive use.



Reduced Center of Gravity

Greater comfort and extended wear.



Unintensified Large Field-of-View

For improved depth perception and CQB capability.

SPECIFICATIONS

	AN/PVS-21	CEHUD	COTM	MODEL 2740	REFOCUS LENS
PHYSICAL FEATURES					
ADJUSTMENTS:	Tilt - 14° on the goggle IPD - 55 mm to 8mm	Tilt - 14° on the goggle IPD - 55 mm to 8mm	-	Tilt - 14° on the goggle IPD - 55 mm to 8mm	
WEIGHT:	760 grams / 26.8 ounces	Display Module - 44 grams / 2.5 ounces Helmet-Mounted Power Module - 250 grams / 8.8 ounces Vest/Pocket Power Module - 250 grams / 8.8 ounces	170 grams 6 ounces	440 grams 15.5 ounces	
AUXILIARY ILLUMINATION SOURCE:	Two IR LEDs - Off/Low/High	-	-	IR LED - Off/Low/High	
POWER:	AA battery 1.5-3.6V alkaline or lithium	(4) AA batteries	(4) CR 123	AA batteries 1.5-3.6V alkaline or lithium	
MOUNTS:	Precision, quick-release mounting on helmets and head harnesses. Integrated HUD port for sensor integration	Precision, quick-release mounting on helmets and head harnesses. Integrated HUD port for sensor integration. Vest/Pocket Power Module - 76mm x 146mm x 39mm	-	Precision, quick-release mounting on helmets and head harnesses. Integrated HUD port for sensor integration.	
OPTICAL PERFORMANCE					
DISPLAY	-	Color capable SVGA	-	-	
UNAIDED FOV:	165° horizontal and 90° verticle	-	-	165° horizontal and 90° verticle	
OBJECTIVE FOCUS:	33 cm to infinity	-	Fixed from 5 meters to infinity	33 cm to infinity	
EXIT PUPIL	10 mm on axis	-	-	10 mm on axis	
EYE RELIEF	15 mm	-	-	15 mm	
THERMAL CAMERA SPECTRUM	-	-	8 to 12 μm	-	
ENVIRONMENTAL					
OPERATING TEMPERATURE RANGE:	-30°C (-22°F) to 52°C (126°F)	-30°C (-22°F) to 52°C (126°F)	-30°C (-22°F) to 60°C (140°F)	-30°C (-22°F) to 52°C (126°F)	
STORAGE TEMPERATURE RANGE:	-52°C (-67°F) to 65°C (149°F)	-40°C (-40°F) to 65°C (149°F)	-40°C (-40°F) to 65°C (149°F)	-55°C (-65°F)	
WATERPROOF:	3 meter standard, 10 meter optional	Up to 10 meters	Waterproof to 3 meters	3 meter standard, 10 meter optional	
MSRP	\$22,999.99	\$8,321.99	\$15,829.99	\$11,929.99	
UNIVERSAL REFOCUS FLIP LENS					
ANGULAR FIELD OF VIEW:	30°				
FOCUS RANGE:	~20 in. to 24 in.				
APPLICATIONS:	AN/PVS -7,-14,15,18,-23, AN/AVS-6,-9				
DIMENSIONS:	41mm (1.6in) x 54 mm (2.1 in.) x 19 mm (0.75 in.)				
WEIGHT:	10.5g (0.4 ounces)				
MSRP	\$89.99				
AN/PVS-21 REFOCUS FLIP LENS					
ANGULAR FIELD OF VIEW:	30°				
FOCUS RANGE:	~20 in. to 24 in.				
APPLICATIONS:	AN/PVS-21				
DIMENSIONS:	48mm (1.7in) x 45 mm (1.7 in.) X 30mm (1.2 in.)				
WEIGHT:	12 g (0.5 ounces)				
MSRP	\$109.99				



UNIVERSAL REFOCUS FLIP LENS

This lens allows the operator to perform momentary close-in tasks such as map-reading or weapon clearing. The operator can then instantly return the NVG to infinity by flipping the lens back

ITEM NO. 9413 UPC 000381894137



AN/PVS-21 REFOCUS FLIP LENS

This lens allows the operator to perform momentary close-in tasks such as map-reading or weapon clearing. The operator can then instantly return the NVG to infinity by flipping the lens back

ITEM NO. 9412 UPC 000381894120

NOVA



MULTI-SPECTRAL COMBAT IDENTIFICATION BEACON.

THE NOVA BEACON IS A MULTI-SPECTRAL COMBAT ID BEACON WITH THERMAL, NIR AND WHITE LED EMITTERS THAT COVERTLY MARKS BLUE FORCE PERSONNEL AND VEHICLES.

NOVA

The NOVA Beacon is a multi-spectral combat ID beacon with thermal, NIR and white LED emitters that covertly marks blue force personnel and vehicles. In thermal mode, THE NOVA BEACON emits no visible signature and is undetectable by conventional night vision. The operator can easily set up the NOVA for NIR, thermal, visible white light or combinations of thermal and NIR.

ITEM NO. 9310 (VIS NIR MWIR) UPC 000381893109
 ITEM NO. 9311 (NIR MWIR SWIR) UPC 000381893116



NOVA OVERALL FEATURES

- POSITIVE ID OF BLUE FORCE ASSETS FROM AIR AND GROUND THERMAL IMAGING SYSTEMS, TARGETING SYSTEMS AND NVGS
- SIX EMITTER LOCATIONS CAN BE EQUIPPED WITH ANY COMBINATION OF EMITTERS
- MULTIPLE NOVA BEACONS CAN BE SYNCHRONIZED TO FLASH IN UNISON
- FLASH PATTERN IS PROGRAMMABLE TO ASSIST IN IDENTIFICATION OF MULTIPLE USERS AND TEAMS
- COMPLETELY SELF-CONTAINED. CAN BE USED ON A HELMET, MOLLE VEST, PACK OR VEHICLE



SPECIFICATIONS

NOVA BEACON

PHYSICAL FEATURES

BATTERIES:	(2) CR 123
RUN TIME:	NIR ~ 24 hours Thermal ~10-12 hours NIR and Thermal ~ 8 hours White Light ~ 4 hours
DIMENSIONS:	2.5 x 2.43 x 1.0 inches
WEIGHT:	116 grams / 4.1 ounce

OPTICAL PERFORMANCE

WAVELENGTH:	880 nm, 3-5 μ m
MAXIMUM OPTICAL POWER:	880 nm ~ 320 mW 3-5 μ m - 350 nm
MAXIMUM LUMINOUS FLUX:	(White) - 80 lumens
OPTICAL DIVERGENCE:	NIR - 132° FWHM Thermal - 100° FWHM (horizontal and vertical) Visible - 115° FWHM

ENVIRONMENTAL

OPERATING TEMPERATURE RANGE:	-30°C (-22°F) to 52°C (126°F)
STORAGE TEMPERATURE RANGE:	-40°C (-40°F) to 65°C (149°F)
SUBMERSIBLE:	3 meters for 30 min.

NORTH STAR



COMBAT IDENTIFICATION BEACON.

NORTH STAR

The North Star beacon has a small profile ideal for covertly marking blue force personnel, vehicle, drop zones and landing zones. It's On-board microprocessor can be factory programmed for custom flash patterns. It is powered by a single CR 123 battery.

THE NORTH STAR IS A MINIATURE BEACON THAT CAN BE USED TO COVERTLY MARK PERSONNEL, VEHICLES OR OTHER HARD TARGETS FOR COMBAT ID/IFF, OR FOR TAGGING AND TRACKING.

ITEM NO. 9312 (MWIR) UPC 000381893123
ITEM NO. 9313 (SWIR) UPC 000381893130



SPECIFICATIONS

NORTH STAR BEACON

PHYSICAL FEATURES

BATTERIES:	(2) CR 123 lithium battery
RUN TIME:	- 880 nm - 15 hours - 3-5 μ m - 150 mW
DIMENSIONS:	2.1 x 1.0 x 0.8 inches
WEIGHT:	49 grams / 1.7 ounce

OPTICAL PERFORMANCE

WAVELENGTH:	880 nm, 3-5 μ m
MAXIMUM OPTICAL POWER:	880 nm ~ 385 mW 3-5 μ m - 130 mW
MAXIMUM LUMINOUS FLUX:	(White) - 80 lumens
OPTICAL DIVERGENCE:	- 880 nm - 128° FWHM - 3-5 μ m - 100° FWHM

ENVIRONMENTAL

OPERATING TEMPERATURE RANGE:	-30°C (-22°F) to 52°C (126°F)
STORAGE TEMPERATURE RANGE:	-40°C (-40°F) to 65°C (149°F)
SUBMERSIBLE:	1 meter for 30 min.

NORTH STAR OVERALL FEATURES

- TAG AND TRACK RED FORCE PERSONNEL AND ASSETS IN RURAL AND URBAN ENVIRONMENTS
- HIGH OPTICAL OUTPUT AND SYNCHRONOUS FLASHING ENSURE LONG-RANGE VISIBILITY IN LOW LIGHT AND NO LIGHT SITUATIONS
- OFFERS SEVERAL ATTACHMENT OPTIONS: SPRING CLIP, TIE DOWN TABS AND NEODYMIUM MAGNETS

The high optical output produces excellent thermal visibility at long range in low-light and no light environments.

MCID



MULTI-SPECTRAL ID BEACON.

THE TRI-BAND MCID IS A MULTI-SPECTRAL COMBAT ID BEACON FOR COVERTLY MARKING BLUE FORCE PERSONNEL AND VEHICLES.



MCID

With its low-profile design, the MCID matches the shape of a helmet for secure attachment and can also be mounted to MOLLE vests, packs or vehicles. Versions are available with mid-wave infrared (MWIR), near infrared (NIR) and short wave infrared (SWIR) or MWIR, NIR and Visible (VIS).

ITEM NO. 9315 (NIR MWIR SWIR) UPC 000381893154
ITEM NO. 9316 (VIS NIR MWIR) UPC 000381893161

MCID OVERALL FEATURES

- MWIR DETECTABLE AT NIGHT AT RANGES UP TO 5-8 NM BY TYPICAL AIRCRAFT IMAGING PODS
- COVERT OPS - THERMAL AND SWIR MODES ARE UNDETECTABLE BY EYE, NVGS AND COMMERCIAL CAMERAS
- LOW-PROFILE TOGGLE SWITCHES PROVIDE INDIVIDUAL CONTROL OF THERMAL, SWIR AND NIR EMITTERS
- HIGH OPTICAL OUTPUT POWER - CLASS I - EYE SAFE
- POWERED BY (3) CR 123 BATTERIES
- HEMISPHERICAL LIGHT DISTRIBUTION FOR VISIBILITY FROM ALL DIRECTIONS
- MULTIPLE MCIDS CAN BE SYNCHRONIZED TO FLASH IN UNISON AND CAN BE PROGRAMMED FOR CUSTOM FLASH PATTERNS AND POWER OUTPUT



The palm-sized MCID has a low-profile lightweight design that matches the curve of the helmet.



SPECIFICATIONS

MCID

PHYSICAL FEATURES

BATTERIES:	(3) CR 123
RUN TIME:	4.5 to 14 hours
DIMENSIONS:	9.5 x 7.5 x 3.8 cm
WEIGHT:	235 grams / 8.3 ounces

OPTICAL PERFORMANCE

WAVELENGTH:	VIS (white) / NIR (880nm) / MWIR (3 to 5 μm)
IN-BAND OPTICAL POWER:	White - 240 Lumens total 880 nm - 960 mW 3-4 μm ~ 1,370 mW
OPTICAL DIVERGENCE:	Greater than hemispherical: 360° azimuth x 200° elevation
DETECTABLE RANGE:	(nighttime MWIR LITENING targeting pod) - 5 to 8 km

ENVIRONMENTAL

OPERATING TEMPERATURE RANGE:	-30°C (-22°F) to 60°C (140°F)
WATERPROOF:	Dust and Waterproof (10 meters immersion for 30 minutes)

STAR BEACON



THERMAL IFF BEACON.

THE STAR BEACON IS A STATE OF THE ART THERMAL IFF BEACON THAT IS UNDETECTABLE BY THE NAKED EYE, NIGHT VISION GOGGLES OR COMMERCIAL VIDEO CAMERAS.



Star Off



Star On

STAR BEACON OVERALL FEATURES

- POSITIVE ID OF BLUE FORCE ASSETS FROM AIR AND GROUND THERMAL IMAGING SYSTEMS
- MULTIPLE STAR BEACONS CAN BE SYNCHRONIZED TO FLASH IN UNISON
- BATTERY PACK WITH SIX CR123 BATTERIES PROVIDES A MINIMUM OF 5 HOURS OF CONTINUOUS USE.
- EXTERNAL POWER CONNECTOR FOR 12 TO 32 VOLTS DC.
- FULL HEMISPHERICAL DIVERGENCE FOR VISIBILITY FROM HORIZON TO ZENITH

STAR BEACON

The STAR Beacon is a state of the art thermal IFF beacon that is undetectable by the naked eye, night vision goggles or commercial video cameras. IT IS VISIBLE TO MWIR targeting pods for up to 8 nautical miles (15 km). Small with a low-profile that easily mounts to helmets and vehicles.

ITEM NO. 9314 UPC 000381893116

SPECIFICATIONS

STAR BEACON

PHYSICAL FEATURES

BATTERIES:	(2) CR 123 lithium battery
RUN TIME:	- 880 nm - 15 hours - 3-5 μ m - 150 mW
DIMENSIONS:	2.1 x 1.0 x 0.8 inches
WEIGHT:	49 grams / 1.7 ounce

OPTICAL PERFORMANCE

WAVELENGTH:	880 nm, 3-5 μ m
MAXIMUM OPTICAL POWER:	880 nm ~ 385 mW 3-5 μ m - 130 mW
MAXIMUM LUMINOUS FLUX:	(White) - 80 lumens
OPTICAL DIVERGENCE:	- 880 nm - 128° FWHM - 3-5 μ m - 100° FWHM

ENVIRONMENTAL

OPERATING TEMPERATURE RANGE:	-30°C (-22°F) to 52°C (126°F)
STORAGE TEMPERATURE RANGE:	-40°C (-40°F) to 65°C (149°F)
SUBMERSIBLE:	1 meter for 30 min.

AIRFIELD BEACON

COMPACT REMOTELY TRIGGERED BEACON.



THE AIRFIELD BEACON IS A COMPACT, REMOTELY TRIGGERED BEACON DESIGNED FOR MARKING COVERT AIRSTRIPS AND LANDING ZONES.

AIRFIELD BEACON OVERALL FEATURES

- EVERY BEACON DOUBLES AS A TRANSMITTER, CAPABLE OF TRIGGERING ANY OTHER BEACON
- IT CAN BE EQUIPPED WITH A VARIETY OF EMITTERS IN THE VISIBLE AND NEAR IR WAVEBANDS
- THREE OPERATING MODES: CONTINUOUS AT MEDIUM POWER CONTINUOUS AT HIGH POWER AND 1 HZ FLASHING AT HIGH POWER
- MODES ARE EASILY PROGRAMMED BY USB AND FLASH PATTERNS CAN BE CUSTOMIZED
- HEMISPHERICAL LIGHT DISTRIBUTION FOR VISIBILITY FROM ALL DIRECTIONS
- WEATHERPROOF AND SHOCK RESISTANT

AIRFIELD BEACON

The Airfield Beacon's UHF transceiver is programmed with seven discrete channels and can be remotely activated from up to 6km away. With standard night vision goggles it can be detected from 15 km. The "All" setting lets the operator turn on every beacon regardless of channel. Beacons can be placed on the ground or attached to stakes with internal magnets



The Airfield beacons uses a UHF transceiver programmed with seven discrete channels. There are three modes: continuous at medium power; continuous at high power and 1 Hz flashing on high power.



The modes can be programmed with a USB port. The user can customize flash patterns.



MADE IN USA

ITEM NO. 9319 (Backpack kit of 10) UPC 000381893178
ITEM NO. 9318 (Individual) UPC 000381893185



Beacons can be placed on the ground, or attached to stakes using their internal magnets for better visibility.

AIRFIELD BEACON KITS INCLUDE:

- 10 Airfield Beacons
- Elevation Pole Top Plate (1 per pole)
- 3-Piece Elevation Pole (1 per beacon)(each pole is 12")
- Elevation Pole Tip (1 per pole)
- Ground Stake (2 per beacon)
- Beacon Kit Back Pack
- Operation Manual
- Beacon Kit Mallet (1 per Beacon Kit)
- Beacon Kit Extra Antenna (2 per Beacon Kit)
- Beacon Kit Extra Emitter Window (1 per Beacon Kit)

SPECIFICATIONS

AIRFIELD BEACON

PHYSICAL FEATURES

BATTERIES:	Four (4) CR123 Batteries
DIMENSIONS:	9.5 x 8.1 x 4.8 cm
WEIGHT:	500 grams / 17.6 ounces
NUMBER OF EMITTERS:	9 (3 of each wavelength)

ENVIRONMENTAL

OPERATING TEMPERATURE RANGE:	-30°C (-22°F) to 70°C (158°F)
STORAGE TEMPERATURE RANGE:	-40°C (-40°F) to 80°C (176°F)
WATERPROOF:	IP68 Rating

STEINER ACCESSORIES



FOR YOUR SCOPE

GET THE PROPER
ACCESSORIES TO
MAXIMIZE THE
EFFECTIVENESS
OF YOUR STEINER
RIFLESCOPE



ANTI-REFLECTION DEVICES (ARD)

Steiner ARDs reduce up to 100% of reflection or "glint" from objective lenses with their honeycomb pattern. Available for M-Series binoculars and M5Xi riflescopes.

ITEM NO. 5901 (3-15X50MM M5XI) UPC 000381859013
ITEM NO. 5902 (5-25X56MM M5XI) UPC 000381859020



SUNSHADES

Steiner sunshades help reduce glare and sun reflections off riflescope objective lenses. The black anodized sunshades can be easily attached by screwing onto the objective housing. Available for M5Xi Military riflescopes.

ITEM NO. 5903 (3-15X50MM M5XI) UPC 000381859037
ITEM NO. 5904 (5-25X56MM M5XI) UPC 000381859044



THROW LEVER T5Xi / P4Xi

Designed for fast and easy magnification changes from any shooting position with a simple push or pull on the lever. Easy to attach without modifying the power ring.

ITEM NO. 5927 UPC 000381859273



SCOPE COVERS

Scopecoat scope covers are designed to fit Steiner scopes for maximum protection of your Steiner Optic. High quality neoprene/nylon laminate will protect your optic from dust, dirt, dings, scratches, and moisture. Elongated sides allow complete coverage for your turrets.

ITEM NO. 7701 (SCOPE COVER 10.0" X 50MM)
UPC 000381877017
ITEM NO. 7702 (SCOPE COVER 12.5" X 42MM)
UPC 000381877024
ITEM NO. 7703 (SCOPE COVER 15.5" X 60MM)
UPC 000381877031



ANTI-REFLECTION DEVICES (ARD)

Steiner ARDs reduce up to 100% of reflection or "glint" from objective lenses with their honeycomb pattern. Available for M-Series binoculars and M5Xi riflescopes.

ITEM NO. 730 (8X30/6X30/7X35/7X30 PORRO)
UPC 000381807304
ITEM NO. 750 (7X50 AND 10X50 PORRO)
UPC 000381807502

FOR YOUR BINOCULARS

ADD MORE
CONVENIENCE
AND COMFORT TO
YOUR STEINER
BINOCULARS
WITH THESE FINE
ACCESSORIES



CLICLOC® BODY HARNESS SYSTEM

Permits hands-free binocular carry. Raise the binocular to your eyes for quick viewing; return it to your chest when done. Binocular is securely attached to the adjustable harness, and has removable quick-release buckles.

ITEM NO. 986 UPC 077068009863
(fits all models, except compacts)



FLOAT STRAP

Padded in a visible yellow, long-lasting waterproof jacket, the Steiner marine binocular Float Strap with ClicLoc® adapts to most marine binoculars and many others.

ITEM NO. 76803 UPC 840229100989
(fits Navigator Pro, Commander and Global Commander 7x50 models)
ITEM NO. 76804 UPC 840229100996
(fits Navigator Pro 7x30 model only)



BINOCULAR CASES

Protect your binocular and transport it easily with a stylish Steiner binocular case.

ITEM NO. 605 (PORRO, SHORT BARREL: 8X30, 6X30, 7X35, 7X30)
ITEM NO. 606 (PORRO, SHORT BARREL: 7X50, 10X50)
ITEM NO. 609 (PORRO, LONG BARREL: 7X50, 8X56, 10X50, 12X56)
UPC 000381806093
ITEM NO. 610 (PORRO, LONG BARREL: 9X40, 10X40, 12X40)
ITEM NO. 612 (DELUXE BINOCULAR CASE: 30MM PORRO)
UPC 000381806123
ITEM NO. 613 (DELUXE BINOCULAR CASE: 42MM ROOF)
UPC 000381806130
ITEM NO. 977 (BLUE; PORRO, SHORT BARREL: 8X30, 7X30)
UPC 000381809773
ITEM NO. 978 (CAMO GEAR BAG: 15X80, 20X80)



BINOCULAR COVERS

Protect your binocular and transport it easily with a stylish Steiner binocular cover.

ITEM NO. 7704 (ROOF BLK 842, 1042) UPC 000381877048
ITEM NO. 7705 (ROOF OD 842, 1042) UPC 000381877055
ITEM NO. 7706 (PORRO BLK 830) UPC 000381877062
ITEM NO. 7707 (PORRO OD 830) UPC 000381877079
ITEM NO. 7708 (PORRO BLK 750, 1050) UPC 000381877086
ITEM NO. 7709 (PORRO OD 750, 1050) UPC 000381877093



STEINER OPTICS **PRODUCT WARRANTIES**

The Steiner Heritage™ Warranty means we stand behind our products. Over half a century of experience building rugged and reliable, mil-spec product and supplying them to armed forces all around the world allows us to have this kind of confidence. We at Steiner are totally committed to the very highest standards of quality, dependability, and most of all customer satisfaction. Our Heritage™ Warranty assures you of that commitment.



STEINER HERITAGE™ WARRANTY - FOR THE LIFE OF THE PRODUCT

Covers Binoculars, Riflescopes, Rings, and Mounts.

Valid in U.S. and Canada only on items manufactured since 2014.

Products manufactured prior to 2014 are covered by the warranty as stated on the original packaging. For warranties in other countries, please visit www.Steiner.de

We will repair or replace the product at no charge to you. The Steiner Heritage Warranty does not cover loss, theft, deliberate damage or cosmetic damage that does not hinder the performance of the product.

- No warranty card needed.
- No receipt required.
- Warranty is fully transferable to future owners of the product.
- Excludes electronic components which are covered by a 3-year warranty
- Excludes accessories.

To register your product online, visit the Binoculars and Riflescopes Warranty Registration page at <https://www.steiner-optics.com/optics-product-registration>

STEINER 2-YEAR WARRANTY

Covers all Night Vision Devices, Laser Aiming Solutions, Beacons and Battle Lights.

Valid in U.S. and Canada only.

For warranties in other countries, please visit www.Steiner.de

For 2 years from the date of purchase, this warranty covers all laser, optical and electrical components, materials and workmanship.

Warranty is void if the product has been abused, misused, neglected, or disassembled prior to the return to the manufacturer.

To register your product online, visit the Laser Devices and Battle Lights Warranty Registration page.

<https://www.steiner-optics.com/optics-product-registration>

STEINER CUSTOMER SERVICE

Your Steiner optics are backed by a commitment to optimum performance and your complete satisfaction - today, every day, for generations to come. Any questions or concerns will be quickly addressed by experts at our national headquarters in Greeley, Colorado. Just call us at **970-356-1670 (888-228-7747 toll-free)** Monday through Friday from 8:00 AM to 5:00 PM MST. Or, email us at info@steiner-optics.com. To post ideas, comments or suggestions, go to our Facebook page. We always welcome your input.

STEINER OPTICS SALES REPRESENTATIVES

COMMERCIAL SALES

Please call

STEINER DEALER SUPPORT

Tel: 970-356-1670

Toll Free: 888-228-7747

SPECIALTY ELECTRONICS REP GROUP

FOTO'S FINEST | BRIAN OSHRIN

SPECIALTY ELECTRONICS

Tel: 631-928-8080

Fax: 631-928-8001

COMMERCIAL SALES

■ **ELITE OUTDOOR SPORTS** Tel: 517-420-2212

■ **PERPETUAL MARKETING** Tel: 757-288-6604

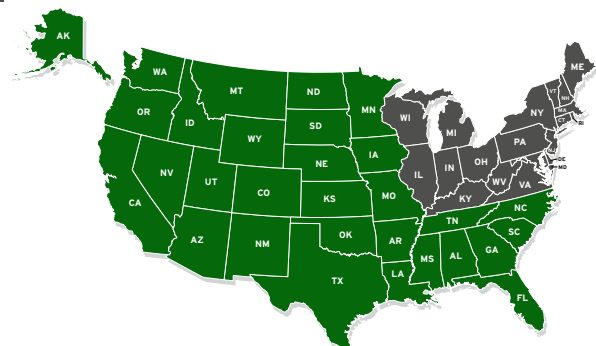



WWW.STEINER-OPTICS.COM

UNITED STATES

STEINER-OPTICS
1015 39th Avenue
Greeley, CO 80634
Tel: 970-356-1670
Toll free: 888-228-7747
Fax: 970-356-8702

CANADA

STOEGER CANADA LTD.
Unit 1, 1801 Wentworth St.
Whitby, V1N 8R6
Tel: 905-436-9077
Toll free: 800-263-1945
Fax: 905-436-9079



STEINER-OPTICS is a
Beretta Holding company