

CAED EX

DEFENCE



2019 CATALOG

- Military
- Law Enforcement
- Precision Shooting

NEW FOR 2019

R7 MODELS **CDX-R7**

Sheepdog Evo short action
Shepherd Evo long action



SHEEPDOG SHEPHERD

PAGE 5-6

FALCON BIPOD

New longer legs



FALCON BIPOD



Extension legs





PAGE 54

BOTTOM METALS

CDX-R7 CDX-30/300/33





Short action Short action

Long action Long action

CDX-50



PAGE 61-62

TRIPOD

Arca adaptor



RC2 adaptor



PAGE 59

ARCA RAIL



M-L0K PAGE 60

TAKEDOWN MODEL

CDX-R7 C.O.P.S

308 Win, 1:10 twist, 16.5"
Optional new screw on compact suppressor



SHEEPDOG SHEPHERD

PAGE 7-8



Takedown



Compact

MX2 TACTICAL MUZZLE BRAKE

with suppressor threads



PAGE 29

CHEEK REST

Neoprene cheek pad



PAGE 28

MAGAZINE

10 round AICS DSSF
3.850" CIP magazine



PAGE 63

FIELD QD CHASSIS



PAGE 43-44

MOSSBERG 500/590

Buttstock Adaptor



PAGE 75

Saddle Mount



PAGE 76

Modular fore-end pump



PAGE 78

DX2 EVO TRIGGER

Convertible trigger



Single stage or double stage within seconds

PAGE 28

M-L0K ACCESSORIES



3" accessory rail



5" accessory rail



3.5" bipod rail



9" bipod rail



Flush cup mount

PAGE 58











KESTREL HOLDER



PAGE 81



CONTENTS

Sniper rifles.....	4-30	
Chassis systems.....	31-50	
Weapon accessories.....	51-74	
Shotgun accessories.....	75-78	
Electro-Optic.....	79-86	
Machine gun.....	87-100	
Breaching methods.....	101-107	
Promotional materials.....	108	
Cadex armor.....	109-112	
R&D solutions.....	113	
Contact us.....	114	



WE ARE PROUD TO HAVE BEEN AWARDED ISO 9001:2015 CERTIFICATION

By achieving this level of certification, we demonstrate that we meet the high quality standards. We would also like to take this opportunity to express our sincere thanks to our customers for their continued commitment and loyalty. We look forward to bringing our business to new heights in the years to come and put the emphasis of quality assurance and innovation.

AND MANY MORE TO COME FOR THE COMPETITION SHOOTERS!

"As a Professional Shooter for over 20 years, I have had the opportunity to experience and trial many different Precision Firearms. As a Sniper, I have very high standards when it comes to Precision Rifles, and to be honest, most manufacturers fall flat!

I have been shooting Cadex Precision Rifles for four years now, and to date, the Cadex Team has developed a line of the world's most accurate Precision Rifles. In choosing Cadex as your Brand, you have decided to take shooting to a whole new level!

Choose Right! Choose Cadex!"

Rob Furlong, Former Canadian Sniper
& President Rob Furlong's Marksmanship Academy - www.rfma.ca

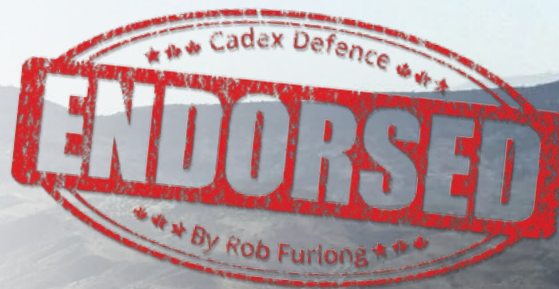

World record sniper kill
March 2002
Operation Anaconda
50 BMG - 2657 yards



R7 MODULARITY

ACTIONS
R7 SHEEPDOG
R7 SHEPHERD



CALIBERS

SHEEPDOG (Short Action)	6 Creedmoor
	260 Rem
	6.5 Creedmoor
	6.5x47 Lapua
SHEPHERD (Long Action)	308 Win
	300 Win Mag
	300 Norma Mag
	338 Lapua Mag
	338 Norma Mag



CDX-R7 SHEEPDOG & SHEPHERD
RIFLES



CDX-R7 LITE COMP
RIFLES



CDX-R7 FIELD COMP
RIFLES

PRECISION RIFLES

CDX-R7 SHEEPDOG & SHEPHERD

The CDX-R7 Sheepdog and Shepherd are precision rifles designed for shooters who prefer a traditional style stock to chassis systems. These rifles feature Cadex's new fully adjustable synthetic stock called the Strike Nuke Evo. The ergonomics of this stock are a great blend between the stability offered by benchrest stocks and lightweight hunting stocks. This stock features a built-in aluminum micro-chassis system for improved accuracy. This out of the box rifle is as good as a custom gun.



CDX-R7 SHEEPDOG (Short action)

Dimensions*:
47.11" x 3.91" x 7.73" | 119.66 x 9.93 x 19.63 cm

Weight*: 13 lbs | 5897 grams

**With muzzle brake. Based on 26" barrel.*

CDX-R7 SHEPHERD (Long action)

Dimensions*:
47.96" x 3.91" x 7.73" | 121.82 x 9.93 x 19.63 cm

Weight*: 13.5 lbs | 6123 grams

**With muzzle brake. Based on 26" barrel.*



***MX2 TACTICAL MUZZLE BRAKE INCLUDED**

**Riflescope, scope mount and bipod sold separately*

**Optional bipod rail not included*

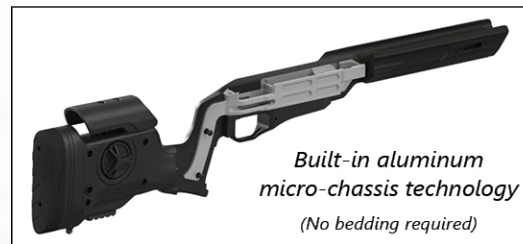

Built-in aluminum micro-chassis technology
(No bedding required)

CALIBER	TOP RAIL			BARREL LENGTH				TWIST RATE					THREAD PITCH		SUPPRESSOR BAND
	0 MOA	20 MOA	30 MOA	20"	24"	26"	27"	1:11"	1:10"	1:9"	1:8"	1:7"	5/8-24	3/4-24	
SHEEPDOG 6 Creedmoor	On request	•	On request		Barlein only	Barlein only							•		N/A
260 Rem	On request	•	On request		•	On request							•		N/A
6.5 Creedmoor	On request	•	On request		•	On request							•		N/A
6.5x47 Lapua	On request	•	On request		•	On request							•		N/A
SHEPHERD 308 Win	On request	•	On request	On request	•	On request		•	Barlein only	Barlein only			•		N/A
300 Win Mag	On request	On request	•	On request	•			•					•		N/A
300 Norma Mag	On request	On request	•	Barlein only	Barlein only				Barlein only	Barlein only			•		N/A
338 Lapua Mag	On request	On request	•			•			•				•		N/A
338 Norma Mag	On request	On request	•			•			•				•		N/A

FEATURES / SPECIFICATIONS

- Easy rebarreling system
- Bolt action repeater, Rem 700 footprint
- 1.350" custom grade action
- 416 stainless action, bolt and barrel
- AICS magazine compatible (5 or 10 round)
- Interchangeable pinned top rail in 0, 20 or 30 MOA
- Ultra-fast 4 lug bolt with 50° bolt throw
- 1/4 turn tool-free bolt disassembly
- Cerakote non-reflective paint
- Unisig 1.238" straight taper fluted match grade barrel
- Built-in aluminum micro-chassis (Strike Nuke Evo)
- Equipped with a DX2 Evo two-stage trigger
- Round bolt knob standard (or optional oversized cross hatch)

See complete rifle stock features at page 31-32

OPTIONAL ITEMS



Bean bag rider (#03127-269)



NVD rail system (#03127-695)



Spacer Kit (3 pcs.) (#03127-K016)



MX1 muzzle brake



Monopod rail with flush cup (#03127-A173)

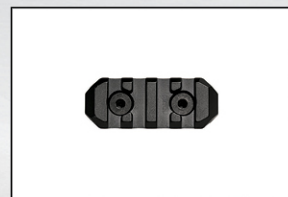

Standard monopod rail (#02528-012)

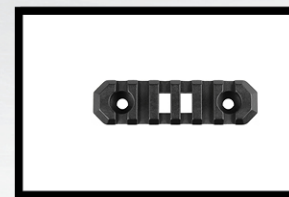

3" accessory rail (#03127-A078ML)



Aluminum bipod rail (#03127-A002ML)

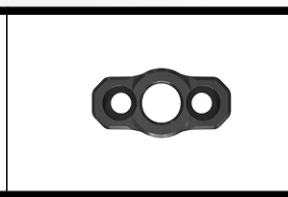

Flush cup adaptor (#03127-A174ML)

PRECISION RIFLES

CDX-R7 C.O.P.S

The new Cadex CDX-R7 C.O.P.S. (Carabine Optimisée Pour Sniper) is designed around the ultra-fast R7 Sheepdog action. Law Enforcement agencies around the world are in need of a "covert" type short/medium range sniper rifle package, capable to be discreetly carried to their spotting location without alarming the population. In the case of a threat, the CDX-R7 C.O.P.S. is a guardian angel.

CDX-R7 C.O.P.S

Dimensions*:
 33.5" x 4" x 7.89" | 119.66 x 9.93 x 20.04 cm
 Without buttstock: 26.74" x 4" x 7.89" | 67.9 x 9.93 x 20.04 cm

Weight*: 10.49 lbs | 4750 grams

**Without muzzle brake. Based on 16.5" barrel.*



**Riflescope, scope mount, bipod and suppressor sold separately*

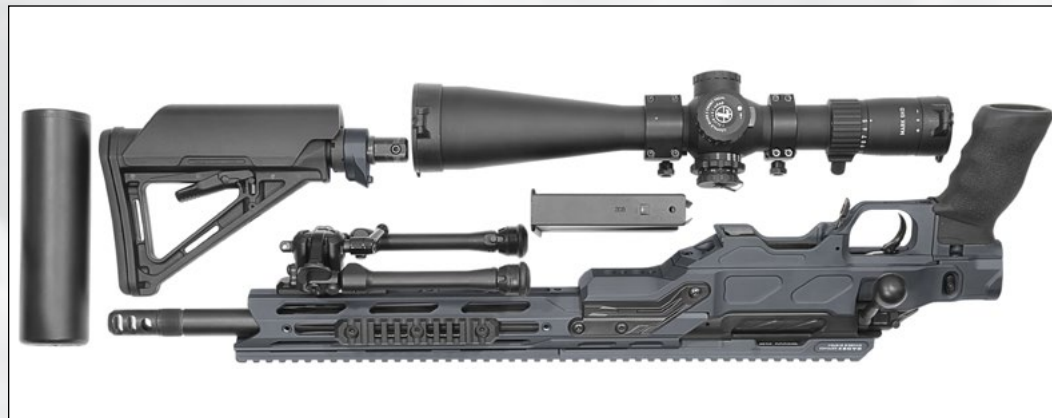

FEATURES / SPECIFICATIONS

- Easy rebarreling system
- Bolt action repeater, Rem 700 footprint
- 1.350" custom grade action
- 416 stainless action, bolt and barrel
- AICS magazine compatible (5 or 10 round)
- Pinned 20 MOA full length top rail
- Ultra-fast 4 lug bolt with 50° bolt throw
- 1/4 turn tool-free bolt disassembly
- Field QD (quick detach) chassis for ultra-fast takedown
- Cerakote non-reflective paint
- Bartlein 1.238" straight taper fluted match grade barrel
- Equipped with a DX2 Evo two-stage trigger
- Round bolt knob standard (or optional oversized cross hatch)
- Accessory rails at 3, 6 and 9 o'clock

See complete rifle stock features at page 43-44

CALIBER	BARREL LENGTH	TWIST RATE	THREAD PITCH
308 Win	16.5"	1:10	5/8-24
Other configurations, calibers and barrel length available for Military and LE applications			

OPTIONAL ITEMS



MX1 muzzle brake



Centre bipod rail (#03127-A019)



Centre accessory rail kit (2) (#03127-A083)



Compact suppressor (#6426-A103)



Arca tripod adaptor (#03127-960-K1)



RC2 tripod adaptor (#03127-962-K1)

CDX-R7 LITE COMP

PRECISION RIFLES

The CDX-R7 Lite Competition includes all features required by the most demanding competitive shooters. Its folding stock mechanism is a charm when it comes to cleaning and transport. The lightning fast R7 action with its 4 lug 50° bolt throw is a must to save time on PRS style stages. Based on a Rem 700 footprint and combined with a medium contour Bartlein Single Point Cut match grade barrel for optimum performance. **NEW!** Now compatible with M-LOK accessories. Visit the Cadex website for all upcoming M-LOK and Arca style accessories.

CDX-R7 LITE COMP (Short action)

Dimensions*:
45.08" x 4" x 7.6" | 114.5 x 10.16 x 19.3 cm

Dimensions folded*:
35.71" x 4.37" x 7.6" | 90.7 x 11.1 x 19.3 cm

Weight*: 12.95 lbs | 5879 grams
With muzzle brake: 13.6 lbs | 6169 grams

*Without muzzle brake. Based on 26" barrel.

CDX-R7 LITE COMP (Long action)

Dimensions*:
45.93" x 4" x 7.6" | 116.66 x 10.16 x 19.3 cm

Dimensions folded*:
36.56" x 4.37" x 7.6" | 92.86 x 11.1 x 19.3 cm

Weight*: 13.15 lbs | 5965 grams
With muzzle brake: 13.79 lbs | 6255 grams

*Without muzzle brake. Based on 26" barrel.



*Riflescope, scope mount, bipod and muzzle brake sold separately
*Optional M-LOK bipod rail not included

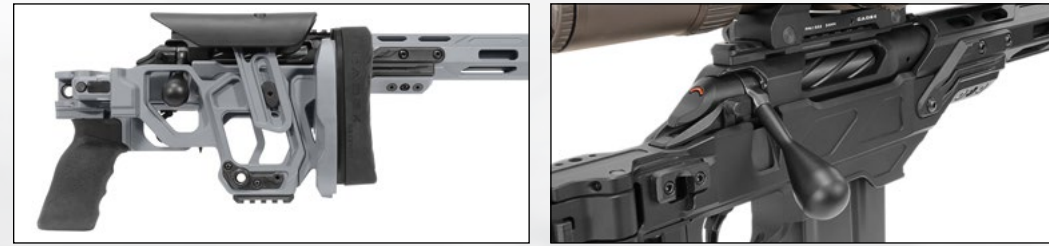

CALIBER	TOP RAIL			BARREL LENGTH				TWIST RATE					THREAD PITCH		SUPPRESSOR BAND	
	0 MOA	20 MOA	30 MOA	20"	24"	26"	27"	1:11 1/2	1:10	1:9 1/2	1:9	1:8	1:7 1/2	5/8-24		3/4-24
SHEPHERD 6 Creedmoor	On request	•	On request		•	On request							•			N/A
260 Rem	On request	•	On request		•	On request								•		N/A
6.5 Creedmoor	On request	•	On request		•	On request								•		N/A
6.5x47 Lapua	On request	•	On request		•	On request								•		N/A
308 Win	On request	•	On request	On request	•	On request		•	On request	On request				•		N/A
SHEPHERD 300 Win Mag	On request	On request	•	On request	•			•						•		N/A
300 Norma Mag	On request	On request	•	On request	•					On request	•			•		N/A
338 Lapua Mag	On request	On request	•			•			•						•	N/A
338 Norma Mag	On request	On request	•			•			•						•	N/A













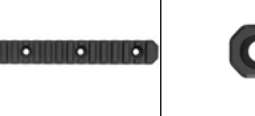

FEATURES / SPECIFICATIONS

- Easy rebarreling system
- Bolt action repeater, Rem 700 footprint
- 1.350" custom grade action
- 416 stainless action, bolt and barrel
- AICS magazine compatible (5 or 10 round)
- Interchangeable pinned top rail in 0, 20 or 30 MOA
- Ultra-fast 4 lug bolt with 50° bolt throw
- 1/4 turn tool-free bolt disassembly
- Lite Competition chassis (folding stock)
- Cerakote non-reflective paint
- Bartlein 1.238" straight taper fluted match grade barrel
- Equipped with a DX2 Evo two-stage trigger
- Round bolt knob standard (or optional oversized cross hatch)

See complete rifle stock features at page 35-36

OPTIONAL ITEMS



						
MX1 muzzle brake	Aluminum bipod rail (#03127-A002ML)	3" accessory rail (#03127-A078ML)	5" accessory rail (#03127-A017ML)	9" bipod rail (#03127-K015ML)	Flush cup adaptor (#03127-A174ML)	Arca rail (#03127-959ML)
						
Monopod rail with flush cup (#03127-A173)	Centre bipod rail (#03127-A019)	Centre accessory rail kit (2) (#03127-A083)	Bean bag rider (#03127-269)	Buttstock spacer 1 5/16" (#03127-265)	Arca tripod adaptor (#03127-960-K1)	RC2 tripod adaptor (#03127-962-K1)

PRECISION RIFLES

CDX-R7 FIELD COMP

The CDX-R7 Field Competition includes most features of the Lite Competition model but in a fixed stock variant. The polymer detachable base of the Field Series is a solid and cost effective solution that will satisfy the most demanding shooters. The fixed skeleton stock is completely tool-free and benefits the weight saving of the competition models. The CDX-R7 Field Competition is the best bang for your buck. **NEW!** Now compatible with M-LOK accessories. Visit the Cadex website for all upcoming M-LOK and Arca style accessories.

CDX-R7 FIELD COMP (Short action)
Dimensions*:
 45" x 4" x 7.6" | 114.3 x 10.16 x 19.3 cm
Weight*: 12.9 lbs | 5851 grams
 With muzzle brake: 13.54 lbs | 6141 grams
**Without muzzle brake. Based on 26" barrel.*

CDX-R7 FIELD COMP (Long action)
Dimensions*:
 45.85" x 4" x 7.6" | 116.46 x 10.16 x 19.3 cm
Weight*: 13.1 lbs | 5942 grams
 With muzzle brake: 13.74 lbs | 6232 grams
**Without muzzle brake. Based on 26" barrel.*



*Riflescope, scope mount, bipod and muzzle brake sold separately
 *Optional bean bag rider, centre bipod rail and M-LOK 9" bipod rail not included



CALIBER	TOP RAIL			BARREL LENGTH				TWIST RATE					THREAD PITCH		SUPPRESSOR BAND	
	0 MOA	20 MOA	30 MOA	20"	24"	26"	27"	1:11 1/2	1:10	1:9 1/2	1:9	1:8	1:7 1/2	5/8-24		3/4-24
SHEPHERD 6 Creedmoor	On request	•	On request		•	On request							•			N/A
260 Rem	On request	•	On request		•	On request							•			N/A
6.5 Creedmoor	On request	•	On request		•	On request							•			N/A
6.5x47 Lapua	On request	•	On request		•	On request							•			N/A
308 Win	On request	•	On request	On request	•	On request		•	On request	On request			•			N/A
SHEPHERD 300 Win Mag	On request	On request	•	On request	•			•					•			N/A
300 Norma Mag	On request	On request	•	On request	•					On request	•		•			N/A
338 Lapua Mag	On request	On request	•			•			•					•		N/A
338 Norma Mag	On request	On request	•			•			•					•		N/A















FEATURES / SPECIFICATIONS

- Easy rebarreling system
- Bolt action repeater, Rem 700 footprint
- 1.350" custom grade action
- 416 stainless action, bolt and barrel
- AICS magazine compatible (5 or 10 round)
- Interchangeable pinned top rail in 0, 20 or 30 MOA
- Ultra-fast 4 lug bolt with 50° bolt throw
- 1/4 turn tool-free bolt disassembly
- Field Competition chassis (fixed stock)
- Cerakote non-reflective paint
- Bartlein 1.238" straight taper fluted match grade barrel
- Equipped with a DX2 Evo two-stage trigger
- Round bolt knob standard (or optional oversized cross hatch)

See complete rifle stock features at page 41-42

OPTIONAL ITEMS



						
MX1 muzzle brake	Aluminum bipod rail (#03127-A002ML)	3" accessory rail (#03127-A078ML)	5" accessory rail (#03127-A017ML)	9" bipod rail (#03127-K015ML)	Flush cup adaptor (#03127-A174ML)	Arca rail (#03127-959ML)
						
Monopod rail with flush cup (#03127-A173)	Centre bipod rail (#03127-A019)	Centre accessory rail kit (2) (#03127-A083)	Bean bag rider (#03127-269)	Buttstock spacer 1 5/16" (#03127-265)	Arca tripod adaptor (#03127-960-K1)	RC2 tripod adaptor (#03127-962-K1)

MULTI-CALIBER SYSTEM

CDX-MC KRAKEN

The CDX-MC KRAKEN, is a multi-caliber rifle using an innovative (patent pending) barrel change system. This multi-caliber system features the lowest shift of point of impact between takedown and reassembly of the same barrel on the market. Cadex CDX-MC uses a traditional barrel to action threading system while incorporating a special tool designed to unscrew and torque its barrel from the breech side. A single screw secures the chassis detachable base for a fast conversion between short and long action calibers. Maintaining the same P.O.I. is critical at extreme range and the Kraken surpass any other multi-caliber system on the market.

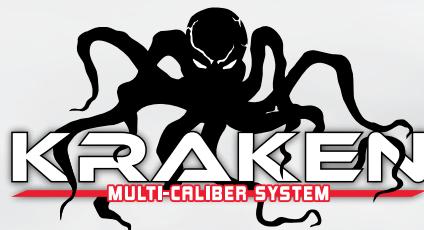

CDX-MC KRAKEN
Dimensions*:
 46.1" x 4.2" x 8" | 117.1 x 10.67 x 20.32 cm
Dimensions folded*:
 37.2" x 4.9" x 8" | 94.49 x 12.45 x 20.32 cm
Weight*: 15.2 lbs | 6877 grams
 With muzzle brake: 15.8 lbs | 7167 grams
**Without muzzle brake. Based on 26" barrel.*



*Riflescope, scope mount, bipod and muzzle brake sold separately
 *Shown with optional suppressor band



Barrel change tools complete kit (optional) Available with Skeleton Stock

CALIBER	TOP RAIL			BARREL LENGTH				TWIST RATE					THREAD PITCH			CALIBER GROUP	
	20 MOA	30 MOA	45 MOA	20"	24"	26"	27"	1:11 ¹ / ₂	1:10	1:9 ¹ / ₈	1:9	1:8	1:7 ¹ / ₂	5/8-24	3/4-24		3/4-20 with suppressor band
6 Creedmoor	On request	On request	On request		On request											On request	B
260 Rem	On request	On request	On request		On request											On request	B
6.5 Creedmoor	On request	On request	On request		On request											On request	B
6.5x47 Lapua	On request	On request	On request		On request											On request	B
308 Win	On request	On request	On request	On request	On request			On request	On request							On request	B
300 Win Mag	On request	On request	On request	On request				On request								On request	C
300 Norma Mag	On request	On request	On request	On request					On request							On request	D
338 Lapua Mag	On request	On request	On request													On request	D
338 Norma Mag	On request	On request	On request													On request	D

FEATURES / SPECIFICATIONS

- Easy rebarreling system
- Bolt action repeater
- Heavy duty 1.550" custom grade action
- 416 stainless action, bolt and barrel
- Mirage mitigation technology fore-end
- Multiple caliber group bolts (B, C, D)
- AICS style magazine compatible
- Fast change between calibers (2 to 3 minutes) with no P.O.I. shift
- 1.300" heavy barrel straight taper with barrel band and threaded muzzle for slip on suppressor or muzzle brake
- Bartlein 5R Single Point Cut rifling technology
- 3 lug bolt with 60° bolt throw
- 1/4 turn tool-free firing pin disassembly
- Cerakote non-reflective paint
- Easy access to trigger group and conversion kit
- Equipped with a DX2 Evo two-stage trigger
- Round bolt knob standard (or optional oversized cross hatch)

See complete rifle stock features at page 33-34

OPTIONAL ITEMS

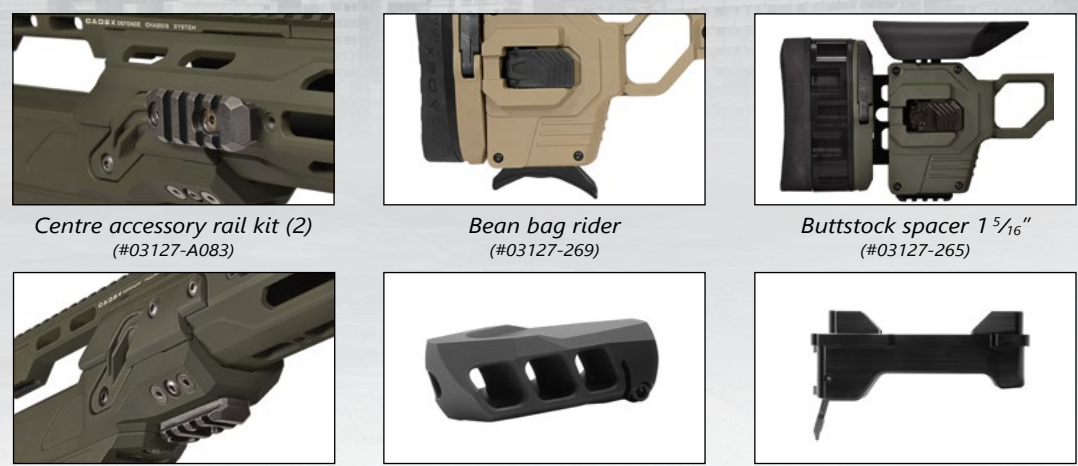

Centre accessory rail kit (2) (#03127-A083)

Bean bag rider (#03127-269)

Buttstock spacer 1 5/16" (#03127-265)

Centre bipod rail (#03127-A019)

MX1 muzzle brake

Conversion Kit

CDX-LITE

CDX-30 GUARDIAN
CDX-300 FREEDOM
CDX-33 PATRIOT

The CDX-30 Guardian LITE, CDX-300 Freedom LITE, and CDX-33 Patriot LITE precision rifles combine all mandatory features that an operator needs in the field. Nothing is left to chance and every detail has been designed to offer the best long range sub-minute sniper system on the market. The CDX precision rifles will be your most reliable partner. Often imitated but never equaled. One shot, one kill... Then extract safely.

MODEL	CALIBER	TOP RAIL			BARREL LENGTH				TWIST RATE					THREAD PITCH			
		20 MOA	30 MOA	45 MOA	20"	24"	26"	27"	1:11 1/2	1:10	1:9 1/2	1:9	1:8	1:7 1/2	5/8-24	3/4-24	3/4-20 with suppressor band
CDX-30 Guardian	6 Creedmoor	• On request	• On request	• On request	•	•									•	• On request	
	260 Rem	• On request	• On request	• On request	•	•									•	• On request	
	6.5 Creedmoor	• On request	• On request	• On request	•	•									•	• On request	
	6.5x47 Lapua	• On request	• On request	• On request	•	•									•	• On request	
CDX-300 Freedom	308 Win	• On request	• On request	• On request	• On request	• On request			• On request	• On request					•	• On request	
	300 Win Mag	• On request	• On request	• On request	• On request	•			•						•	• On request	
CDX-33 Patriot	300 Norma Mag	• On request	• On request	• On request	• On request	•					• On request	•			•	• On request	
	338 Lapua Mag	• On request	• On request	• On request			•				•				•	• On request	
	338 Norma Mag	• On request	• On request	• On request			•				•				•	• On request	



*Riflescope, scope mount, bipod and muzzle brake sold separately

FEATURES / SPECIFICATIONS

- Easy rebarreling system
- Bolt action repeater
- Heavy duty 1.550" custom grade action
- 416 stainless action, bolt and barrel
- Bartlein 1.300" straight taper fluted match grade barrel with 5R Single Point Cut rifling technology
- Includes a right and left cheek piece
- Short action (10 round)
- Long action (5 round)
- 3 lug bolt with 60° bolt throw
- 1/4 turn tool-free firing pin disassembly
- Cerakote non-reflective paint
- Mirage mitigation technology fore-end
- With or without suppressor band
- Equipped with a DX2 Evo two-stage trigger
- Round bolt knob standard (or optional oversized cross hatch)

See complete rifle stock features at page 35-36



OPTIONAL ITEMS



Centre accessory rail kit (2) (#03127-A083)



Bean bag rider (#03127-269)



Buttstock spacer 1 5/16" (#03127-265)



Centre bipod rail (#03127-A019)



MX1 muzzle brake



Available with Skeleton stock

20" BARREL

GUARDIAN

Dimensions*: 39.9" x 3.7" x 7.7" | 101.35 x 9.4 x 19.56 cm
Dimensions folded*: 31.1" x 4.7" x 7.7" | 78.99 x 11.94 x 19.56 cm
Weight*: 13.1 lbs | 5969 grams - With muzzle brake: 13.8 lbs | 6259 grams
**Without muzzle brake.*

24" BARREL

GUARDIAN, FREEDOM AND PATRIOT

Dimensions*: 43.9" x 3.7" x 7.7" | 111.5 x 9.4 x 19.56 cm
Dimensions folded*: 35.1" x 4.7" x 7.7" | 89.15 x 11.94 x 19.56 cm
Weight*: 13.5 lbs | 6151 grams - With muzzle brake: 14.2 lbs | 6441 grams
**Without muzzle brake.*

26" BARREL

GUARDIAN, FREEDOM AND PATRIOT

Dimensions*: 45.9" x 3.7" x 7.7" | 116.58 x 9.4 x 19.56 cm
Dimensions folded*: 37.1" x 4.7" x 7.7" | 94.23 x 11.94 x 19.56 cm
Weight*: 13.7 lbs | 6241 grams - With muzzle brake: 14.4 lbs | 6531 grams
**Without muzzle brake.*

27" BARREL

PATRIOT

Dimensions*: 46.9" x 3.7" x 7.7" | 119.13 x 9.4 x 19.56 cm
Dimensions folded*: 38.1" x 4.7" x 7.7" | 96.77 x 11.94 x 19.56 cm
Weight*: 13.8 lbs | 6277 grams - With muzzle brake: 14.5 lbs | 6567 grams
**Without muzzle brake.*

PRECISION RIFLES

CDX-TAC

CDX-30 GUARDIAN
CDX-300 FREEDOM
CDX-33 PATRIOT

The CDX-30 Guardian TAC, CDX-300 Freedom TAC, and CDX-33 Patriot TAC sniper rifles are cost efficient solutions for law enforcement agencies or the civilian market that do not see an advantage in a folding stock mechanism. Same reliability and accuracy combined into a well proven package at a fraction of the cost.

MODEL	CALIBER	TOP RAIL			BARREL LENGTH				TWIST RATE					THREAD PITCH		
		20 MOA	30 MOA	45 MOA	20"	24"	26"	27"	1:11 1/4	1:10	1:9 1/2	1:9	1:8	1:7 1/2	5/8-24	3/4-24
CDX-30 Guardian	6 Creedmoor	•	On request	On request		•	•							•		On request
	260 Rem	•	On request	On request		•	•								•	On request
	6.5 Creedmoor	•	On request	On request		•	•								•	On request
	6.5x47 Lapua	•	On request	On request		•	•								•	On request
	308 Win	•	On request	On request	On request	•	On request		•	On request	On request				•	On request
CDX-300 Freedom	300 Win Mag	On request	•	On request		On request	•		•					•	On request	
CDX-33 Patriot	300 Norma Mag	On request	•	On request		On request	•			On request	•			•	On request	
	338 Lapua Mag	On request	•	On request				•						•	On request	
	338 Norma Mag	On request	•	On request			•			•				•	On request	



*Riflescope, scope mount, bipod and muzzle brake sold separately

FEATURES / SPECIFICATIONS

- Easy rebarreling system
- Bolt action repeater
- Heavy duty 1.550" custom grade action
- 416 stainless action, bolt and barrel
- Bartlein 1.300" straight taper fluted match grade barrel with 5R Single Point Cut rifling technology
- Short action (10 round)
- Long action (5 round)
- 3 lug bolt with 60° bolt throw
- 1/4 turn tool-free firing pin disassembly
- Cerakote non-reflective paint
- Mirage mitigation technology fore-end
- With or without suppressor band
- Equipped with a DX2 Evo two-stage trigger
- Round bolt knob standard (or optional oversized cross hatch)

See complete rifle stock features at page 39-40

20" BARREL

GUARDIAN
Dimensions*: 39.9" x 3.7" x 7.7" | 101.35 x 9.4 x 19.56 cm
Weight*: 12 lbs | 5516 grams - With muzzle brake: 12.8 lbs | 5806 grams
 *Without muzzle brake.

24" BARREL

GUARDIAN, FREEDOM AND PATRIOT
Dimensions*: 43.9" x 3.7" x 7.7" | 111.5 x 9.4 x 19.56 cm
Weight*: 12.4 lbs | 5607 grams - With muzzle brake: 13 lbs | 5897 grams
 *Without muzzle brake.

26" BARREL

GUARDIAN, FREEDOM AND PATRIOT
Dimensions*: 45.9" x 3.7" x 7.7" | 116.58 x 9.4 x 19.56 cm
Weight*: 12.6 lbs | 5697 grams - With muzzle brake: 13.2 lbs | 5987 grams
 *Without muzzle brake.

27" BARREL

PATRIOT
Dimensions*: 46.9" x 3.7" x 7.7" | 119.13 x 9.4 x 19.56 cm
Weight*: 12.7 lbs | 5745 grams - With muzzle brake: 13.3 lbs | 6035 grams
 *Without muzzle brake.

OPTIONAL ITEMS



Centre accessory rail kit (#03127-A083)



Bean bag rider (#03127-269)



Buttstock spacer 1 5/16" (#03127-265)



Centre bipod rail (#03127-A019)



MX1 muzzle brake

CDX-40 SHADOW 375 CT 408 CT

The CDX-40 Shadow is the Cadex Precision Rifle chambered in either 375 or 408 CT. These ultimate calibers were designed for extreme range shooting and anti-materiel up to 4000 yards with proper training and shooting conditions. Push your limits even further with the CDX-40 SHADOW. Renown by the ELR community as the best extreme range platform on the market.

CDX-40 SHADOW

Dimensions*:
49.9" x 4.3" x 8.25" | 126.75 x 10.92 x 21 cm

Dimensions folded*:
41" x 5.04" x 8.25" | 104.14 x 12.8 x 21 cm

Weight*: 18.5 lbs | 8391 grams
With muzzle brake: 19.4 lbs | 8808 grams

*Without muzzle brake. Based on 29" barrel.

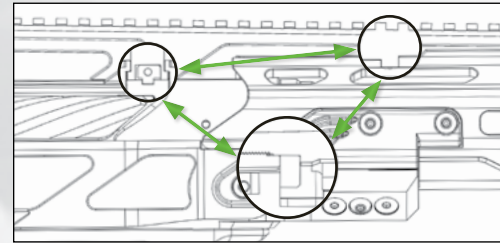

Triple recoil lug system



Available with Skeleton Stock

FEATURES / SPECIFICATIONS

- Easy rebarreling system
- Bolt action repeater
- Heavy duty 1.600" custom grade action
- 416 stainless action, bolt and barrel
- Bartlein 1.350" straight taper fluted match grade barrel
- Mirage mitigation technology fore-end
- 1/4 turn tool-free firing pin disassembly
- 29" or 32" match grade Bartlein Single Point Cut rifling barrel
- 3 lug bolt with 60° bolt throw
- 20, 40 or 60 MOA full length top rail
- Cerakote non-reflective paint
- 7 round magazine DSSF
- Very low recoil compared to 50 BMG
- Equipped with a DX2 Evo two-stage trigger
- Round bolt knob standard (or optional oversized cross hatch)

See complete rifle stock features at page 33-34

CALIBER	TOP RAIL			BARREL LENGTH		TWIST RATE				THREAD PITCH	SUPPRESSOR BAND	
	20 MOA	40 MOA	60 MOA	29"	32"	1:7 (5R (6 groove))	1:10 (5R (6 groove))	1:11 (6R (6 groove))	1:12 (6R (6 groove))	1:13 (6R (6 groove))		7/8-24
375 CT	On request	•	On request	On request	•	On request	•	On request			•	On request
408 CT	On request	•	On request	•	On request			On request	•		•	On request



*Riflescope, scope mount, bipod and muzzle brake sold separately
*Shown with optional suppressor band

OPTIONAL ITEMS



Centre accessory rail kit (2) (#03127-A083)



Bean bag rider (#03127-269)



Buttstock spacer 1 5/16" (#03127-265)



Centre bipod rail (#03127-A019)



MX1 muzzle brake (#3850-045)

CDX-50 TREMOR 50 BMG

The CDX-50 TREMOR, a 50 caliber Precision Rifle built to Military Spec, is capable of delivering a huge payload accurately while maintaining very manageable recoil. The CDX-50 is a lightweight bolt action rifle that brings new technology to the 50 BMG of years gone by. This is the ultimate extreme range anti-materiel rifle.

CDX-50 TREMOR

Dimensions*:
51.5" x 4.6" x 8.4" | 130.81 x 11.68 x 21.34 cm

Dimensions folded*:
42.4" x 5.4" x 8.4" | 107.7 x 13.71 x 21.34 cm

Weight*: 22.6 lbs | 10 251 grams
With muzzle brake: 23.9 lbs | 10 836 grams

*Without muzzle brake. Based on 29" barrel.

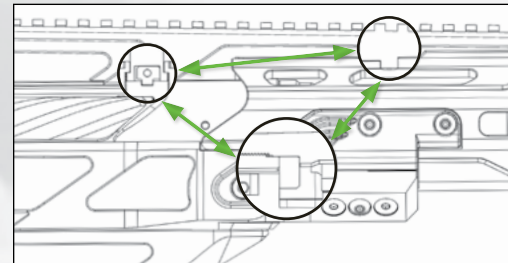

Triple recoil lug system



Available with Skeleton Stock

CALIBER	TOP RAIL		BARREL LENGTH		TWIST RATE	THREAD PITCH	SUPPRESSOR BAND
	20 MOA	40 MOA	29"	32"	1:15 (@ groove)	1-14 UNF	
50 BMG	On request	•	•	On request	•	•	On request

FEATURES / SPECIFICATIONS

- Easy rebarreling system
- Bolt action repeater (5 round)
- Heavy duty 1.960" custom grade action
- 416 stainless action, bolt and barrel
- 29" or 32" fluted match grade, 8 groove, 1:15 twist barrel
- Mirage mitigation technology fore-end
- Bartlein Single Point Cut rifling 1.680" heavy barrel straight taper with barrel band (optional) and threaded muzzle for slip on suppressor or muzzle brake
- 20 MOA or 40 MOA full length top rail
- 4 lug bolt with 50° bolt throw
- 1/4 turn tool-free firing pin disassembly
- Cerakote non-reflective paint
- Equipped with a DX2 Evo two-stage trigger
- Round bolt knob standard (or optional oversized cross hatch)

See complete rifle stock features at page 33-34



BLK TAN ODG SSV GRY HTB HOD HSB HGB



*Riflescope, scope mount, bipod and muzzle brake sold separately

OPTIONAL ITEMS



Centre accessory rail kit (2)
(#03127-A083)



Bean bag rider
(#03127-269)



Buttstock spacer 1 5/16"
(#03127-265)



Centre bipod rail
(#03127-A019)



MX1 muzzle brake
(#3850-044)

NOT SOLD SEPARATELY

ACTION

CDX-MC KRAKEN

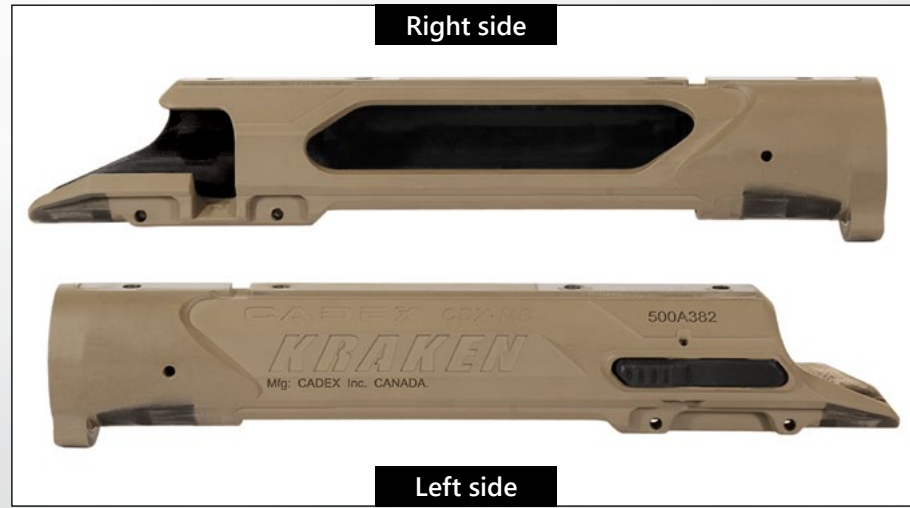

- BLK
- TAN
- ODG
- SSV
- GRY

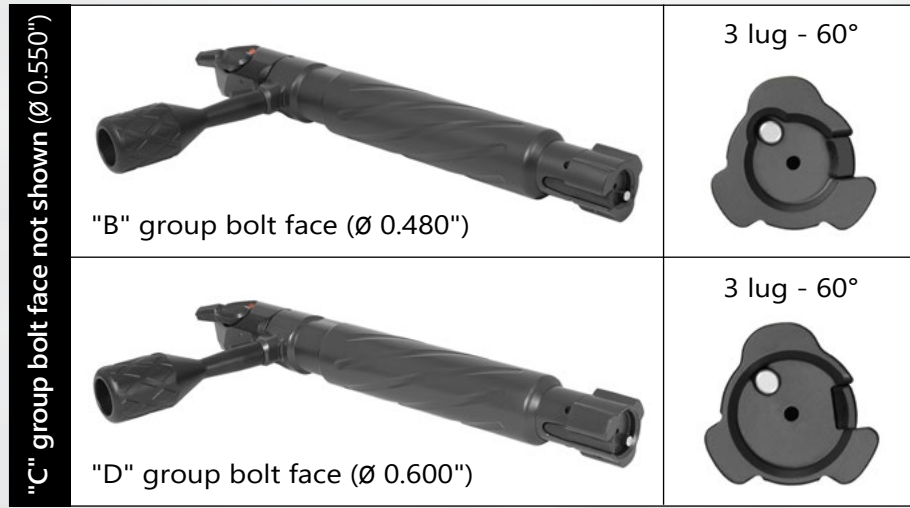

"C" group bolt face not shown (Ø 0.550")

**Shown with optional oversized cross hatch bolt knob*

RECEIVER

- Machining: CNC
- Material: Stainless 416
- Length: 9.150"
- Diameter: 1.550"
- Thread: 1 3/16" -18 tpi
- Hardness: 41-43 HRC
- .350" built-in recoil lug
- Deep laser engraving markings
- Fits up to 3.850" magazines
- Cerakote finish
- #10-32 top rail screws
- Oversize bolt stop pin
- Unique top rail localisation system with integrated recoil groove machined into the action upper section
- Magazine cut out: Short action AICS DSSF or Long action AICS SSSF
- Cadex proprietary footprint
- Compatible with the Cadex DX2 Evo trigger or some Rem Style aftermarket triggers

BOLT

- Machining: CNC
- Material: Stainless 416
- Firing pin: Cadex design with improved locktime
- Cadex heavy duty extractor
- Ejector: Rem style
- Easy 1/4 turn tool-free bolt disassembly
- Hardness: 43-45 HRC
- Multiple bolt faces available: Type B, C, D
- Shroud: Cadex design with 2 position top safety
- Round bolt knob standard (or optional oversized cross hatch)
- Bolt stop: Cadex design
- Spiral fluted 3 lug bolt with 60° bolt throw for rapid cycling
- Cadex design cocking piece
- Easy firing pin assembly replacement
- Same firing pin for all calibers

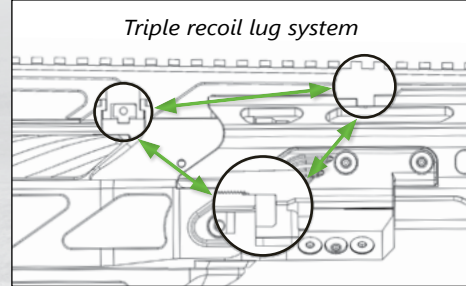

Kraken universal firing pin assembly (Part#: 3850-K016)

REM 700 FOOTPRINT - CUSTOM ACTIONS

AVAILABLE SEPARATELY

CDX-R7 SHEEPDOG & SHEPHERD

(short action)

(long action)

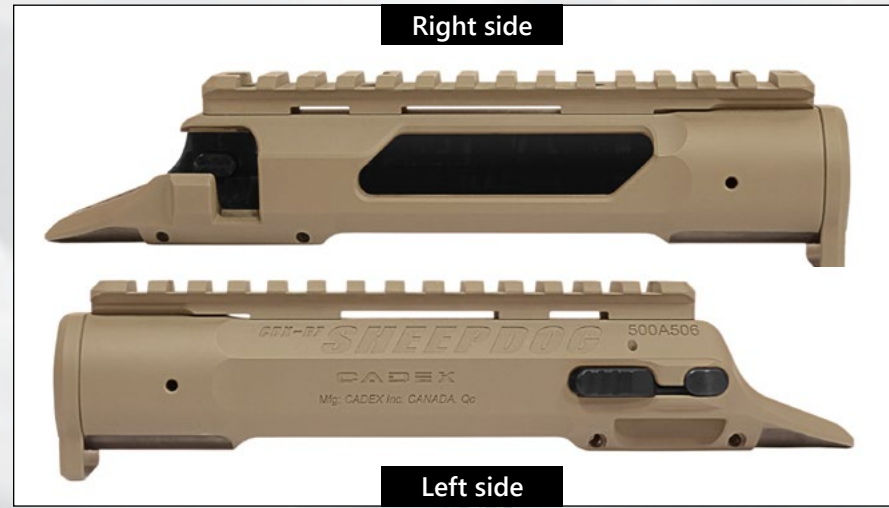

- BLK
- TAN
- ODG
- SSV
- GRY

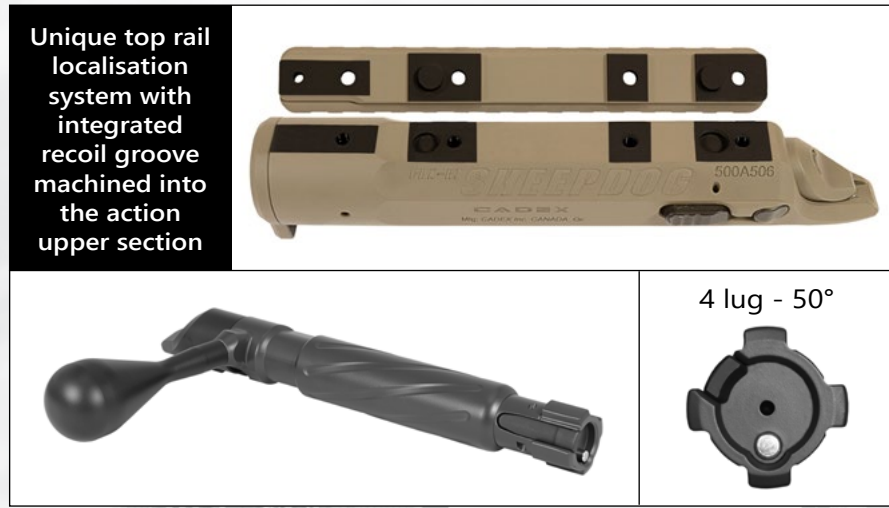

Unique top rail localisation system with integrated recoil groove machined into the action upper section

Visit cadexdefence.com to download the barrel shank drawing

RECEIVER

- Machining: CNC
- Material: Stainless 416
- Length: (Sheepdog: 7.85") (Shepherd: 8.70")
- Weight of the action with bolt: 2.45 lbs / 1111 grams (Sheepdog)
- Diameter: 1.350"
- Thread: 1 1/16" -18 tpi
- Hardness: 41-43 HRC
- Deep laser engraving markings
- Cerakote finish
- .250" hardened steel recoil lug
- Stainless 0, 20, 30 MOA top rail
- 8-40 top rail screws
- Heavy duty bolt stop
- Sheepdog: AICS DSSF 3.055" Shepherd: AICS up to 3.850" CIP
- Perfect Rem 700 footprint
- No modification required
- Compatible with the Cadex DX2 Evo trigger or some Rem Style aftermarket triggers

BOLT

- Machining: CNC
- Material: Stainless 416
- Cadex heavy duty extractor
- Ejector: Rem style
- Tool-free bolt disassembly
- Hardness: 43-45 HRC
- Multiple bolt faces available: Type B, C, D
- Shroud with cocking indicator
- Round bolt knob standard (or optional oversized cross hatch)
- Bolt stop: Cadex design
- Cadex design cocking piece
- Spiral fluted 4 lug bolt with 50° bolt throw for ultra-fast cycling



Compatible with any Cadex chassis for R7 actions



AVAILABLE SEPARATELY

ACTIONS

CDX-30 / CDX-300 / CDX-33

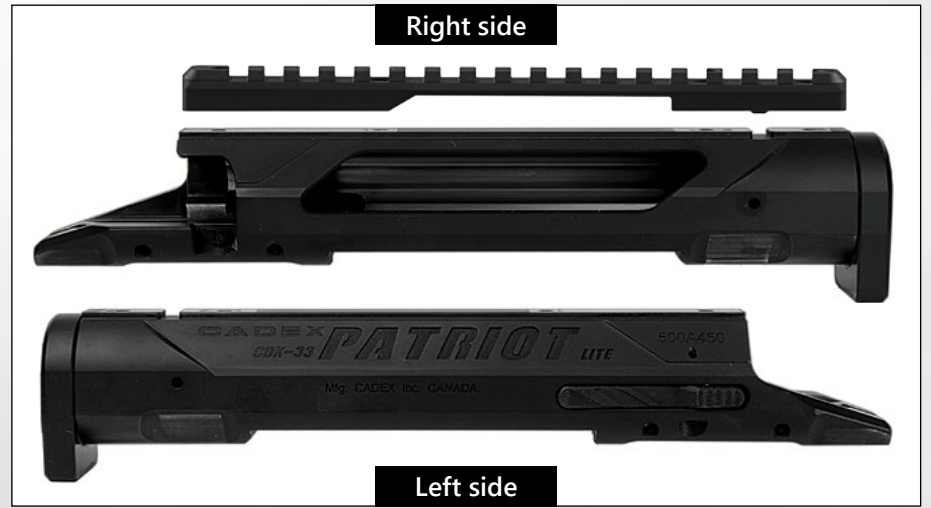

- BLK
- TAN
- ODG
- SSV
- GRY

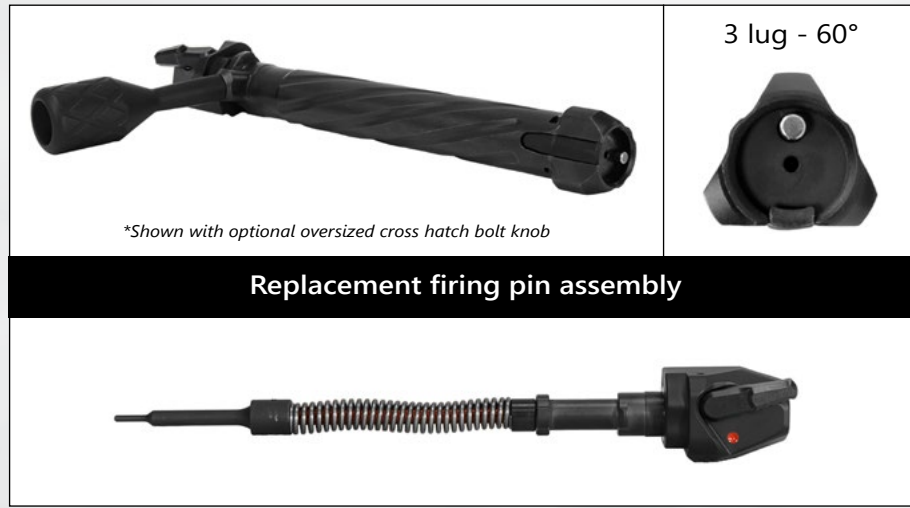

RECEIVER

Visit cadexdefence.com to download the barrel shank drawing

- Machining: CNC and wire EDM
- Material: Stainless 416
- Length: 9"
- Diameter: 1.550"
- Thread: 1 1/16"-18 tpi
- Hardness: 41-43 HRC
- .350" hardened steel recoil lug
- Deep laser engraving markings
- 8-40 top rail screws
- Cerakote finish
- Includes a 20 MOA stainless steel Picatinny rail
- Oversize bolt stop pin
- Unique top rail localization system with integrated recoil groove machined into the action upper section
- Magazine cut out: AICS DSSF or AICS SSSF
- Cadex proprietary footprint
- Compatible with the Cadex DX2 Evo trigger or some Rem Style aftermarket triggers

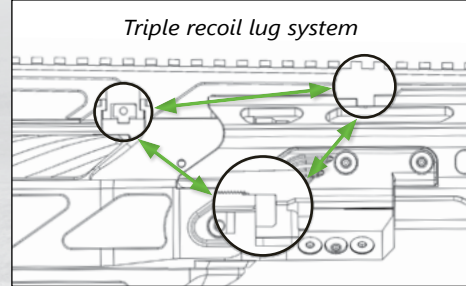

BOLT

- Machining: CNC
- Material: Stainless 416
- Firing pin: Cadex design with improved locktime
- Cadex heavy duty extractor
- Ejector: Rem style
- Easy 1/4 turn tool-free bolt disassembly
- Hardness: 43-45 HRC
- Multiple bolt faces available: Type B, C, D
- Shroud: Cadex design with 2 position top safety
- Round bolt knob standard (or optional oversized cross hatch)
- Bolt stop: Cadex design
- Spiral fluted bolt
- Cadex design cocking piece
- Easy firing pin assembly replacement



ACTIONS

AVAILABLE SEPARATELY

CDX-40 / CDX-50

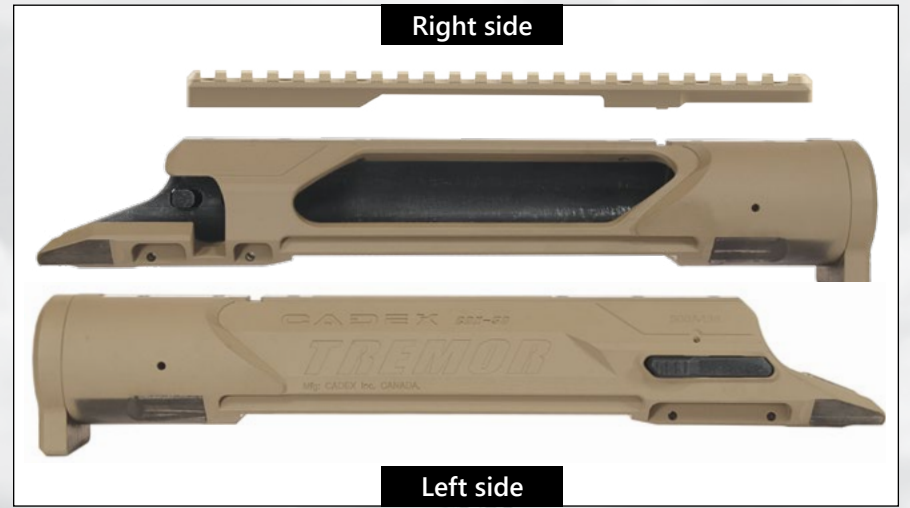

- BLK
- TAN
- ODG
- SSV
- GRY



RECEIVER

Visit cadexdefence.com to download the barrel shank drawing

- Machining: CNC
- Material: Stainless 416
- Length: (40: 10") (50: 11.900")
- Diameter: (40: 1.600") (50: 1.960")
- Thread: (40: 1 3/16"-18 tpi) (50: 1 1/2"-18 tpi)
- Hardness: 41-43 HRC
- 40: .350" hardened steel recoil lug
- 50: .420" hardened steel recoil lug
- 10-32 top rail screws
- Cerakote finish
- Includes a 20 MOA stainless steel Picatinny rail
- Oversize bolt stop pin
- Unique top rail localization system with integrated recoil groove machined into the action upper section
- Magazine cut out: Cadex SSSF or DSSF
- Cadex proprietary footprint
- Compatible with the Cadex DX2 Evo trigger or some Rem Style aftermarket triggers
- Deep laser engraving markings

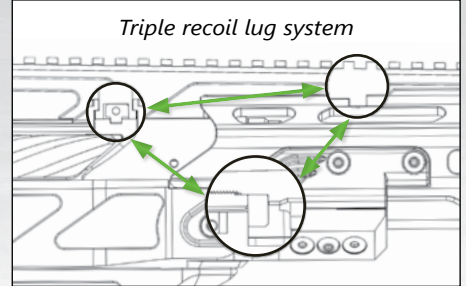

BOLT

- Machining: CNC
- Material: Stainless 416
- Firing pin: Cadex design with improved locktime
- Cadex heavy duty extractor
- Ejectors: Rem style double ejectors
- Easy 1/4 turn tool-free bolt disassembly
- Hardness: 43-45 HRC
- Easy firing pin assembly replacement
- Shroud: Cadex design with 2 position top safety
- Round bolt knob standard (or optional oversized cross hatch)
- Bolt stop: Cadex design
- Spiral fluted bolt
- Cadex design cocking piece
- Bolt face type E: 375/408 CT
- Bolt face type F: 50 BMG



BOLT KNOBS



0.85" x 2.97"
(2.16 x 7.54 cm)

0.98" x 2.98"
(2.49 x 7.57 cm)

- One piece 4140 steel screw-in bolt handle
- 1/4-28 threaded
- A: Oversized cross hatch bolt knob
- D: Rounded knob

IMPORTANT

If bought separately for Cadex rifles, please confirm the caliber and model.

*Green Loctite recommended

SPECIFICATIONS

CDX-30, CDX-300, CDX-33 and R7 series

Part#: 3850-008A - Part#: 3850-008D

SPECIFICATIONS

CDX-40, CDX-50 and CDX-MC Kraken

Part#: 3850-108A - Part#: 3850-108D



REM STYLE TRIGGERS

DX2 EVO Selectable Single/Double Stage

- First stage permanently set between 6 to 8 ounces at the factory
- Adjustable combined pull weight between 1.5 to 2.5 lbs
- Fast access to the trigger pull adjustment screw located at the bottom of the trigger body
- Adjustable trigger shoe positioning for maximum comfort
- Multiple openings machined into the aluminum body to facilitate dirt cleaning
- Improved crispiness
- Improved internal safety mechanism
- Military grade trigger design

The Cadex DX2 EVO trigger is a Double Stage Trigger capable to be rapidly converted into a Single Stage Trigger by its operator. Its trigger pull weight can be easily adjusted between **1.5 to 2.5 lbs**. If you haven't figured yet if you prefer a Single Stage or Double Stage Trigger, you can't go wrong with the DX2 EVO.

*Achievable trigger pull weight can be influenced by multiple factors.

SPECIFICATIONS

DX2 Evo Triggers

Part#: 6119-A002-EVO
(Naked variant)

Part#: 6119-A002R7-EVO
(With safety)

Part#: 6119-A002S-EVO
(With safety and bolt release)

Part#: 6119-A002MC-EVO
(For McMillan 50 BMG)



Easy access pull weight adjustment screw

BARRELS

CADEX BARTLEIN



Fluted barrel - Cadex overlap suppressor ready - Single Point Cut rifling - Optional suppressor band - Includes barrel thread protector cap

In order for Cadex to offer the best extreme range SUB-MOA precision rifle, we selected Bartlein Barrels. Teamed with our Cadex designed straight taper contour, fluted barrel and threaded muzzle, Cadex barrels are Match Grade, Single Point Cut rifling with an optimized twist rate. For all standard calibers, Cadex selected the 5R technology for easier bore cleaning and less bullet jacket deformation. (Except the CDX-R7 Sheepdog & Shepherd rifles)



BEAN BAG RIDER

The Bean Bag Rider was designed to sit securely on your bean bag. The Bean Bag Rider allows the shooter to make minute corrections while ensuring the bean bag won't slip out of position. Adapts to all Cadex rifles or chassis equipped with the Cadex original or Skeleton Stock.



SPECIFICATIONS

Bean Bag Rider Part#: 03127-269

Dimensions:
3.09" x 1.01" x 0.94" | 7.85 x 2.57 x 2.39 cm

Weight: 0.034 lbs | 15.37 grams

Material: Fiber reinforced composite

NEOPRENE CHEEK PAD



For CDX-R7 Sheepdog & Shepherd and Strike Nuke chassis. (Part#: 03127-693-N18)

For any other Cadex rifles or chassis (Part#: 03127-693-L18)

MX1 MUZZLE BRAKE

The Cadex MX1 muzzle brake is designed to deflect the muzzle blast away from the shooter and his spotter. Gases exit sideways and upwards to reduce felt recoil, dust cloud and improve rifle control. It will soften your 338 Lapua recoil as if it was a 243 Win.

HIGHLY EFFECTIVE RECOIL MITIGATION



*Also available in bead blasted finish on special request only

SPECIFICATIONS

5/8-24	Part#: 3850-028 (Remington)
3/4-20	Part#: 3850-022 (PGWDTI)
3/4-24	Part#: 3850-024 (Barrett, Desert Tech)
M18X1	Part#: 3850-034 (Sako-Tikka)
7/8-24	Part#: 3850-045 (375/408 CT)
1-14UNF	Part#: 3850-044 (50 BMG)
Material:	Stainless Steel 416

Fits all calibers up to 338



MX2 TACTICAL MUZZLE BRAKE

NEW 2019



SPECIFICATIONS

Part#: 3850-228-BLK
5/8-24 internal thread fit up to .30 cal.
Part#: 3850-229-BLK
3/4-24 internal thread fit up to .338 cal.



*Picture may differ from actual product

The Cadex MX2 Muzzle Brake design comes from the need to offer a muzzle brake small enough to fit inside a compact suppressor design. The end of the muzzle brake is tapered to perfectly align the compact suppressor. The MX2 Tactical Muzzle Brake is lightweight while maintaining enough performance to control the muzzle jump on the rifle. Comes standard on the CDX-R7 Sheepdog and Shepherd rifles.

SUPPRESSORS

SPECIFICATIONS

Precision rifle suppressors

308 Win/338 Lapua	(3/4-20)	Part#: 6426-A003
375/408 CT	(7/8-24)	Part#: 6426-A004
50 BMG	(1-14 UNF)	Part#: 6426-A002



SPECIFICATIONS

Carbine suppressor 5.56mm

Part#: 6426-A001 Also available in tan
*Attaches to Cadex or Vortex flash hider



SPECIFICATIONS

Carbine 5.56mm Flash Hider with suppressor adaptor

Part#: 6426-059



SPECIFICATIONS

Compact suppressor (30/338 caliber)

Part#: 6426-A103
Dimensions: 7.05" x 2.01" | 17.9 x 5.11 cm



MANTA

SUPPRESSOR COVERS

SPECIFICATIONS

Covers for 5.56mm/308 Win/338 Lapua

Part#: 6426-K006
Dimensions: 7" x 2.13" | 17.78 x 5.41 cm
Weight: 0.46 lbs | 210 grams

SPECIFICATIONS

Covers for 50 BMG

Part#: 6426-K008
Dimensions: 10" x 3.25" | 25.4 x 8.26 cm
Weight: 1.08 lbs | 492 grams



Extremely effective mirage reduction device for suppressors. Available in tan or black.

STRIKE NUKE



The new Cadex Strike Nuke Evo micro-chassis system is designed for shooters looking for traditional stock ergonomics while benefitting from the advantages of chassis systems. The Strike Nuke Evo is a Rem 700 footprint stock adaptable to most Rem 700 custom action clones and Cadex R7 Sheepdog & Shepherd actions. Gen2 improved design with M-LOK technology and high density fiberglass reinforced polymer.

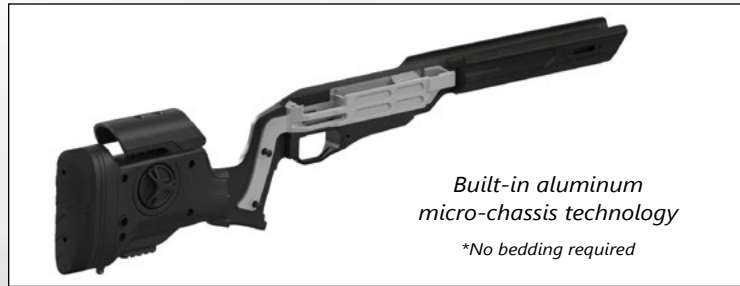

Max. barrel Dia 1.350" straight taper to 1.250"

- 1 RECOIL PAD**
Adjustable recoil pad height.
- 2 LENGTH OF PULL**
Optional additional spacers to increase the L.O.P. (L.O.P: 13.5")
- 3 CHEEK PIECE**
Tool-free up and down cheek piece adjustment. Side to side adjustable.
- 4 QD SLING ATTACHMENT**
Built-in flush cups (both sides).
- 5 OPTIONAL**
Monopod rail or Bean bag rider.

- 6 GRIP**
Ambidextrous palm swell with comfortable thumb rest.
- 7 TRIGGER GUARD**
Oversized trigger guard and magazine release for easy manipulation with gloves.

- 8 ALUMINUM MAG WELL**
- 9 INLETTING**
Designed to fit Rem 700 and clones.
- 10 MAGAZINE**
AICS magazine compatible.

- 11 OPTIONAL**
Aluminum bipod rail.
- 12 OPTIONAL**
Accessory rail kit (2) or flush cup adaptor
- 13 FORE-END TUBE**
Wide semi V-Shaped fore-end.

OPTIONAL ITEMS

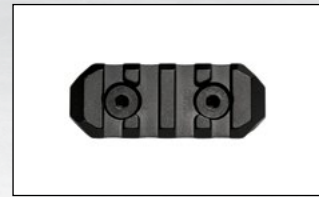

SHORT/LONG ACTION
Dimensions:
31.97" x 2.14" x 6.95" | 81.2 x 5.44 x 17.65 cm
Weight: 5.1 lbs | 2313 grams



Available for Cadex Custom Actions R7 SHEEPDOG & SHEPHERD



Flush cup adaptor (#03127-A174ML) Aluminum bipod rail (#03127-A002ML) 3" accessory rail (#03127-A078ML)

STRIKE SERIES

DUAL STRIKE

Ultimate sniper system currently in use worldwide by special operations units and long range shooters.



Multiple interchangeable magazine sleeves are available to fit most AICS magazines on the market



SHORT ACTION
Dimensions:
 33.5" x 3.1" x 8.13" | 85.09 x 7.87 x 20.65 cm
Dimensions folded:
 24.73" x 4.92" x 8.13" | 62.9 x 12.5 x 20.65 cm
Weight: 7.27 lbs | 3300 grams

LONG ACTION
Dimensions:
 34.25" x 3.1" x 8.13" | 86.99 x 7.87 x 20.65 cm
Dimensions folded:
 25.27" x 4.68" x 8.13" | 64.2 x 11.9 x 20.65 cm
Weight: 7.43 lbs | 3372 grams

50 BMG
Dimensions:
 34" x 3.03" x 8.34" | 86.36 x 7.71 x 21.18 cm
Dimensions:
 24.76" x 5.07" x 8.34" | 62.9 x 12.9 x 21.18 cm
Weight: 8.15 lbs | 3697 grams

Max. barrel Dia 1.800"

CONFIGURATIONS	SA	LA	.204 Ruger	.223 Rem	.22-250 Rem	.243 Win	6.5 CM	.308 Win	.308 Win (M24)	.30-06 Sprig	7mm Rem Mag	.300 Win Mag	.300 WSM	.300 RUM	.338 Lapua	.375 CT	.408 CT	.50 BMG
Rem 700	•	•	•	•	•	•	•	•	•	•	•	•	•	•				
Rem 40-XB	•						•											
Mc Millan		•													•			•
PGWDTI																		•
Stiller Tac & Predator*	•	•	•	•	•	•	•	•	•	•	•	•	•	•	•	•	•	
SAKO TRG	•	•						•			•				•			
Surgeon 591, 1086 & 1581	•	•	•	•	•	•	•	•	•	•	•	•	•	•				
Defiance Rebel only	•	•	•	•	•	•	•	•	•	•	•	•	•	•				
J.J. Rock Super XL		•															•	•

May also fit many other Wildcat calibers *Stiller 408 CT (1.45" & 1.60")

1 TOOL-FREE
 Fully adjustable stock for length of pull, cheek piece and recoil pad height. (L.O.P.: 12.95" - 14.57")

2 MONOPOD RAIL
 Or optional Bean bag rider.

4 GRIP
 Finger-grooved Cadex rubberized grip.

6 DUAL TOP RAIL
 20 MOA full length dual top rail.

8 DETACHABLE BASE
 Provides easy trigger access for maintenance and trigger adjustment. This allows the platform to maintain zero. Made of aluminum.

10 SPARE SCREWS

3 FOLDING BUTTSTOCK
 Reverse folding buttstock offers bolt handle protection and ultra-compact transport.

5 TRIGGER GUARD
 Oversized trigger guard and magazine release for easy manipulation with gloves.

7 CHASSIS
 Made from aircraft grade 6061-T6 aluminum billets, anodized and painted with a military grade non-reflective paint.

9 OPTIONAL
 Centre accessory rail kit (2).

11 OPTIONAL
 Centre bipod rail.

12 FORE-END TUBE
 Heavy Duty fore-end tube providing rail placement at 3, 6 and 9 o'clock.

OPTIONAL ITEMS



Centre accessory rail kit (2) (#03127-A083)



Bean bag rider (#03127-269)



Buttstock spacer 1 5/16" (#03127-265)



Centre bipod rail (#03127-A019)



Available with Skeleton Stock

STRIKE SERIES

LITE STRIKE

Same ultimate sniper rifle system as the Dual Strike model but with emphasis on weight reduction. Small contour fore-end tube with same rail capabilities.



Multiple interchangeable magazine sleeves are available to fit most AICS magazines on the market



Max. barrel Dia 1.350"



SHORT ACTION
Dimensions:
 33.13" x 2.57" x 8" | 84.1 x 6.53 x 20.32 cm
Dimensions folded:
 24.37" x 4.75" x 8" | 61.9 x 12.07 x 20.32 cm
Weight: 6.24 lbs | 2831 grams

LONG ACTION
Dimensions:
 34.05" x 2.57" x 8" | 86.5 x 6.53 x 20.32 cm
Dimensions folded:
 25.19" x 4.75" x 8" | 64 x 12.07 x 20.32 cm
Weight: 6.39 lbs | 2900 grams

1 pound lighter than the Dual Strike model

CONFIGURATIONS	SA	LA	Left Hand	.204 Ruger	.223 Rem	.22-250 Rem	.243 Win	6.5 CM	.308 Win	.308 Win (M24)	.30-06 Sprng	7mm Rem Mag	.300 Win Mag	.300 WSM	.300 RUM	.338 Lapua	.375 CT	.408 CT	.50 BMG
Cadex R7	•	•																	
Rem 700	•	•	•	•	•	•	•	•	•	•	•	•	•	•	•				
Rem 40-XB	•							•											
Savage*	•	•		•	•	•	•	•	•	•	•	•	•	•	•				
PGWDTI**		•													•				
Stiller Tac & Predator	•	•	•	•	•	•	•	•	•	•	•	•	•	•	•				
Tikka T3/T3X (AICS mags)	•		•		•	•	•	•					•						
Tikka T3/T3X (Factory mags)	•	•	•	•	•	•	•	•	•	•	•	•	•						
Tikka T3/T3X CTR	•							•	•	•									

*Savage: 10-11-12-14-16-110-111-114-116 2006 to current generation except 12 target series
 ** PGWDTI: Requires some permanent modifications to the action

1 TOOL-FREE
 Fully adjustable stock for length of pull, cheek piece and recoil pad height. (L.O.P.: 12.95" - 14.57")

2 MONOPOD RAIL
 Or optional Bean bag rider.

4 GRIP
 Finger-grooved Cadex rubberized grip.

6 LITE TOP RAIL
 20 MOA full length top rail.

8 DETACHABLE BASE
 Provides easy trigger access for maintenance and trigger adjustment. This allows the platform to maintain zero. Made of aluminum.

10 SPARE SCREWS

11 OPTIONAL
 Centre bipod rail.

3 FOLDING BUTTSTOCK
 Reverse folding buttstock offers bolt handle protection and ultra-compact transport.

5 TRIGGER GUARD
 Oversized trigger guard and magazine release for easy manipulation with gloves.

7 CHASSIS
 Made from aircraft grade 6061-T6 aluminum billets, anodized and painted with a military grade non-reflective paint.

9 OPTIONAL
 Centre accessory rail kit (2).

12 FORE-END TUBE
 Heavy Duty fore-end tube providing rail placement at 3, 6 and 9 o'clock.

OPTIONAL ITEMS



Centre accessory rail kit (2) (#03127-A083)



Bean bag rider (#03127-269)



Buttstock spacer 1 5/16" (#03127-265)



Centre bipod rail (#03127-A019)



Available with Skeleton Stock

LITE COMPETITION

STRIKE COMPETITION SERIES

The Lite Competition Series features an open top chassis designed to fit all Remington 700 clone actions and several other models. Perfect for custom actions with integrated top rails. It features a mirage mitigation technology fore-end with more bipod placement possibilities. This chassis includes all features required by the most demanding competitive shooters including a folding stock mechanism.

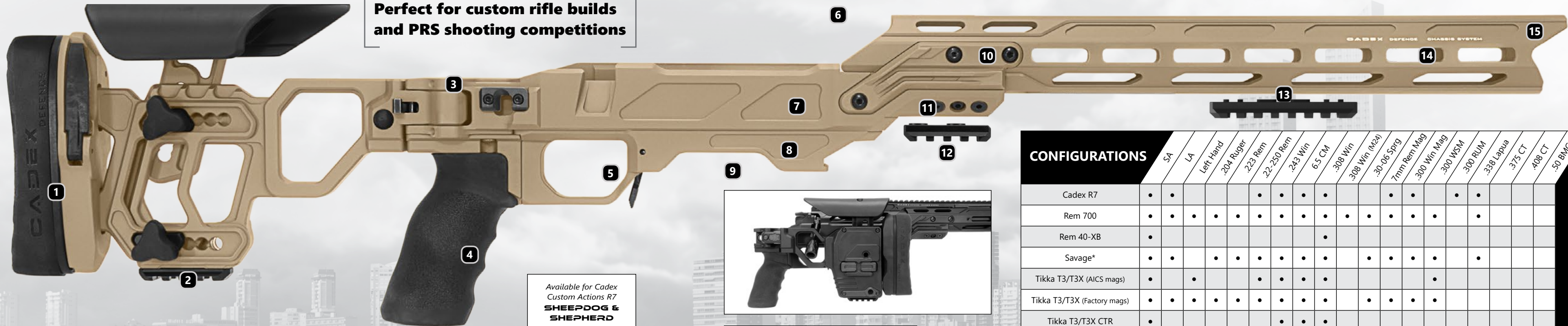

Perfect for custom rifle builds and PRS shooting competitions

SHORT ACTION

Dimensions:
35.74" x 2.3" x 7.17" | 90.78 x 5.84 x 18.21 cm
Dimensions folded:
26.75" x 4.6" x 7.17" | 67.95 x 11.68 x 18.21 cm
Weight: 5 lbs | 2268 grams

LONG ACTION

Dimensions:
36.59" x 2.3" x 7.17" | 92.94 x 5.84 x 18.21 cm
Dimensions folded:
27.57" x 4.6" x 7.17" | 70.03 x 11.68 x 18.21 cm
Weight: 5.61 lbs | 2545 grams

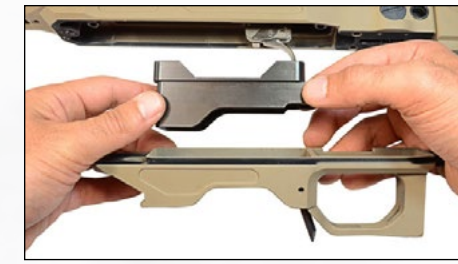

Multiple interchangeable magazine sleeves are available to fit most AICS magazines on the market



Available for Cadex Custom Actions R7 SHEEPDOG & SHEPHERD



OPTIONAL ITEMS

Fit also all accessories from page 58 to 60



Field series 20 MOA top rail



Bean bag rider (#03127-269)



Buttstock spacer 1 5/16" (#03127-265)

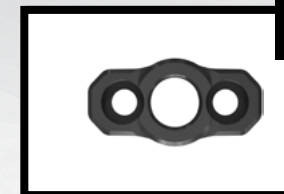

Flush cup adaptor (#03127-A174ML)



Aluminum bipod rail (#03127-A002ML)



Centre bipod rail (#03127-A019)



Centre accessory rail kit (#03127-A083)

CONFIGURATIONS	SA	LA	Left Hand	.204 Ruger	.223 Rem	.22-250 Rem	.243 Win	6.5 CM	.308 Win	.308 Win (M24)	.30-06 Sprig	7mm Rem Mag	.300 Win Mag	.300 WSM	.300 RUM	.338 Lapua	.375 CT	.408 CT	.50 BMG
Cadex R7	•	•			•	•	•	•	•		•	•	•	•	•				
Rem 700	•	•	•	•	•	•	•	•	•	•	•	•	•	•	•				
Rem 40-XB	•							•											
Savage*	•	•		•	•	•	•	•			•	•	•	•	•				
Tikka T3/T3X (AICS mags)	•		•		•	•	•	•					•						
Tikka T3/T3X (Factory mags)	•	•	•	•	•	•	•	•			•	•	•	•					
Tikka T3/T3X CTR	•							•											
Stiller TAC, Pred & Spectre	•	•	•	•	•	•	•	•			•	•	•	•	•				
Defiance (Rem 700 clone only)	•	•	•	•	•	•	•	•			•	•	•	•	•				
Surgeon 591 & 1086	•	•		•	•	•	•	•			•	•	•	•	•				
Xtreme titanium SA & LA	•	•	•	•	•	•	•	•			•	•	•	•					
NEW American Rifle Company (Mausingfield & Nucleus)	•	•		•	•	•	•	•			•	•	•	•					

May also fit many other Wildcat calibers *Savage: 10-11-12-14-16-110-111-114-116 2006 to current generation except 12 target series

1 SKELETON STOCK
Tool-free fully adjustable stock for length of pull, cheek piece and recoil pad height. (L.O.P.: 12.95" - 14.25")

2 MONOPOD RAIL
Or optional Bean bag rider.

3 FOLDING BUTTSTOCK
Reverse folding buttstock offers bolt handle protection and ultra-compact transport.

4 GRIP
Finger-grooved Cadex rubberized grip.

5 TRIGGER GUARD
Oversized trigger guard and magazine release for easy manipulation with gloves.

6 OPEN TOP
Allows optic to be mounted directly on the action using traditional scope bases, Picatinny rail or built-in action rail.

7 CHASSIS
Made from aircraft grade 6061-T6 aluminum billets, anodized and painted with a military grade non-reflective paint.

8 DETACHABLE BASE
Provides easy trigger access for maintenance and trigger adjustment. This allows the platform to maintain zero. Made of aluminum.

9 MAGAZINE
AICS magazine compatible.

10 OPTIONAL
Centre accessory rail kit (2).

11 SPARE SCREWS

12 OPTIONAL
Centre bipod rail.

13 OPTIONAL
M-LOK bipod rail.

14 OPTIONAL
Flush cup sling adaptor.

15 M-LOK FORE-END TUBE
Competition fore-end tube featuring mirage mitigation technology. Longer tube for even more bipod positioning and stability.

Max. barrel Dia 1.350"

FIELD TACTICAL

STRIKE SERIES

SHORT ACTION
Dimensions:
 34" x 2.57" x 8" | 86.36 x 6.53 x 20.32 cm
Weight: 5.50 lbs | 2494 grams

LONG ACTION
Dimensions:
 34.76" x 2.57" x 8" | 88.3 x 6.53 x 20.32 cm
Weight: 5.58 lbs | 2531 grams

Rugged Law Enforcement sniper rifle system with full rail capability and aluminum detachable base. Delivered with full length 20 MOA top rail and accessory rails at 3, 6 and 9 o'clock.



Multiple interchangeable magazine sleeves are available to fit most AICS magazines on the market



Max. barrel Dia 1.350"



CONFIGURATIONS	SA	LA	Left Hand	.204 Ruger	.223 Rem	.22-250 Rem	.243 Win	6.5 CM	.308 Win	.308 Win (M24)	.30-06 Spig	7mm Rem Mag	.300 Win Mag	.300 WSM	.300 RUM	.338 Lapua	.375 CT	.408 CT	.50 BMG
Cadex R7	•	•			•	•	•	•			•	•	•	•					
Rem 700	•	•	•	•	•	•	•	•	•	•	•	•	•	•	•				
Rem 40-XB	•							•											
Savage*	•	•		•	•	•	•	•		•	•	•	•	•	•				
Tikka T3/T3X (AICS mags)	•		•		•	•	•	•				•							
Tikka T3/T3X (Factory mags)	•	•	•	•	•	•	•	•			•	•	•	•					
Tikka T3/T3X CTR	•					•	•	•											
Stiller TAC & Predator	•	•	•	•	•	•	•	•		•	•	•	•	•	•				

May also fit many other Wildcat calibers *Savage: 10-11-12-14-16-110-111-114-116 2006 to current generation except 12 target series

- 1 SKELETON STOCK**
Tool-free fully adjustable stock for length of pull, cheek piece and recoil pad height. (L.O.P.: 12.95" - 14.25")
Now with cleaning rod opening.
- 2 MONOPOD RAIL**
Or optional Bean bag rider.
- 3 GRIP**
Finger-grooved Cadex rubberized grip.

- 4 TRIGGER GUARD**
Oversized trigger guard and magazine release for easy manipulation with gloves.
- 5 CHASSIS**
Made from aircraft grade 6061-T6 aluminum billets, anodized and painted with a military grade non-reflective paint.

- 6 DETACHABLE BASE**
Provides easy trigger access for maintenance and trigger adjustment. This allows the platform to maintain zero. Made of aluminum.
- 7 LITE TOP RAIL**
20 MOA full length top rail.

- 8 OPTIONAL**
Centre accessory rail kit (2).
- 9 FORE-END TUBE**
Small contour fore-end tube providing rail placement at 3, 6 and 9 o'clock.

OPTIONAL ITEMS



Centre accessory rail kit (2) (#03127-A083)



Bean bag rider (#03127-269)



Buttstock spacer 1 5/16" (#03127-265)



Small rubberized Ergo grip (#175-00023-BLK)

Available for Cadex Custom Actions R7
SHEEPDOG & SHEPHERD

STRIKE COMPETITION SERIES

FIELD COMPETITION

The Field Competition Series features an open top chassis designed to fit all Remington 700 clone actions and several other models. Perfect for custom actions with integrated top rail or the Cadex R7 Sheepdog & Shepherd. It features a mirage mitigation technology fore-end with more bipod placement possibilities. This chassis includes all features required by the most demanding competitive shooters.



Available for Cadex Custom Actions R7 SHEEPDOG & SHEPHERD

Max. barrel Dia 1.350"

Perfect for custom rifle builds and long range competition

1 SKELETON STOCK
Tool-free fully adjustable stock for length of pull, cheek piece and recoil pad height. (L.O.P.: 12.95" - 14.25")
Now with cleaning rod opening.

2 MONOPOD RAIL
Or optional Bean bag rider.

3 GRIP
Finger-grooved Cadex rubberized grip.

4 TRIGGER GUARD
Oversized trigger guard and magazine release for easy manipulation with gloves.

5 OPEN TOP
Allows optic to be mounted directly on the action using traditional scope bases, Picatinny rail or built-in action rail.

6 CHASSIS
Made from aircraft grade 6061-T6 aluminum billets, anodized and painted with a military grade non-reflective paint.

7 DETACHABLE BASE
Provides easy trigger access for maintenance and trigger adjustment. This allows the platform to maintain zero. Made of polymer (most models).

8 MAGAZINE
AICS magazine compatible.

9 OPTIONAL
Centre accessory rail kit (2).

10 OPTIONAL
Centre bipod rail. *2018 and up production only

11 OPTIONAL
M-LOK bipod rail.

12 M-LOK FORE-END TUBE
M-LOK competition fore-end tube featuring mirage mitigation technology. Longer tube for even more bipod positioning and stability.

13 OPTIONAL
Flush cup sling adaptor.

SHORT ACTION

Dimensions:
35.66" x 2.3" x 7.17" | 90.58 x 5.84 x 18.21 cm
Weight: 4.75 lbs | 2155 grams

LONG ACTION

Dimensions:
36.51" x 2.3" x 7.17" | 92.74 x 5.84 x 18.21 cm
Weight: 5.37 lbs | 2436 grams



OPTIONAL ITEMS

Fit also all accessories from page 58 to 60



Field series 20 MOA top rail



Bean bag rider (#03127-269)



Buttstock spacer 1 5/16" (#03127-265)

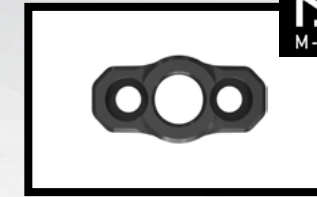

Flush cup adaptor (#03127-A174ML)

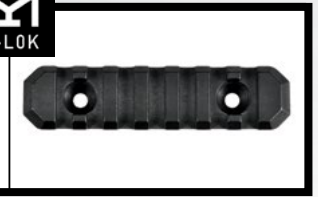

Aluminum bipod rail (#03127-A002ML)



Centre bipod rail (#03127-A019)



Centre accessory rail kit (2) (#03127-A083)

CONFIGURATIONS	SA	LA	Left Hand	.204 Ruger	.223 Rem	.22-250 Rem	.243 Win	6.5 CM	.308 Win	.308 Win (M24)	.30-06 Sprig	7mm Rem Mag	.300 Win Mag	.300 WSM	.300 RUM	.338 Lapua	.375 CT	.408 CT	.50 BMG
Cadex R7	•	•			•	•	•	•			•	•	•	•					
Rem 700	•	•	•	•	•	•	•	•	•	•	•	•	•						
Rem 40-XB	•							•											
Savage*	•	•		•	•	•	•	•			•	•	•	•		•			
Tikka T3/T3X (AICS mags)	•		•		•	•	•	•					•						
Tikka T3/T3X (Factory mags)	•	•	•	•	•	•	•	•			•	•	•						
Tikka T3/T3X CTR	•					•	•	•											
Stiller TAC, Pred & Spectre	•	•	•	•	•	•	•	•			•	•	•	•	•				
Defiance (Rem 700 clone only)	•	•	•	•	•	•	•	•			•	•	•	•	•				
Surgeon 591 & 1086	•	•		•	•	•	•	•			•	•	•	•					
Xtreme titanium SA & LA	•	•	•	•	•	•	•	•			•	•	•	•					
NEW American Rifle Company (Mausingfield & Nucleus)	•	•		•	•	•	•	•			•	•							

May also fit many other Wildcat calibers *Savage: 10-11-12-14-16-110-111-114-116 2006 to current generation except 12 target series

NEW 2019

STRIKE SERIES

FIELD QD

SHORT ACTION

Dimensions:
 31.5" x 2.57" x 8" | 80.01 x 6.53 x 20.32 cm
 Without buttstock: 24.25" x 2.57" x 8" | 61.6 x 6.53 x 20.32 cm
Weight: 4.39 lbs | 1991 grams



Compact and ultralight shooting platform perfect for urban sniping and varmint hunting. Quick detach buttstock system for ease of transportation.

Fast takedown shooting platform



*Shown with recommended optional cheek rest

CONFIGURATIONS	SA	LA	Left Hand	.204 Ruger	.223 Rem	.22-250 Rem	.243 Win	6.5 CM	.308 Win	.308 Win (M24)	.30-06 Sprgr	7mm Rem Mag	.300 Win Mag	.300 WSM	.300 RUM	.338 Lapua	.375 CT	.408 CT	.50 BMG
Rem 700	•			•	•	•	•	•	•										
Cadex R7	•					•	•	•	•										

1 MAGPUL MOE STOCK

Magpul 6-position retractable buttstock. (L.O.P.: 11.0" - 14.25")
(Optional cheek riser highly recommended)

2 BUTTSTOCK

Ultra-fast takedown push-button mechanism.

3 GRIP

Finger-grooved Cadex rubberized grip.

4 TRIGGER GUARD

Oversized trigger guard and magazine release for easy manipulation with gloves.

5 CHASSIS

Made from aircraft grade 6061-T6 aluminum billets, anodized and painted with a military grade non-reflective paint.

6 DETACHABLE BASE

Provides easy trigger access for maintenance and trigger adjustment. This allows the platform to maintain zero. Made of polymer (most models).

7 LITE TOP RAIL

20 MOA full length top rail.

8 OPTIONAL

Centre accessory rail kit (2).

9 OPTIONAL

Centre bipod rail.

10 FORE-END TUBE

Small contour fore-end tube providing rail placement at 3, 6 and 9 o'clock.

OPTIONAL ITEMS



Centre accessory rail kit (2)
 (#03127-A083)



Centre bipod rail
 (#03127-A019)



Recommended 0.75" cheek riser
 (only 4 buttstock positions useable)



Small rubberized Ergo grip
 (#175-00023-BLK)



Available for Cadex Custom Action R7
SHEEPDOG

OBSOLETE MODELS

URBAN STRIKE



TACTICAL CORE



FIELD CORE



OT CORE



AVAILABLE ON REQUEST UNTIL SUPPLIES LAST

Contact Cadex Defence for price and availability



COMPARISON TABLE

CHASSIS MODELS	BUTTSTOCK STYLE			BUTTSTOCK FEATURES				TOP RAIL STYLE		CHASSIS FEATURES			CHASSIS RAILS & ATTACHMENTS											
	Cadex folding stock	Skeleton stock	Micro-chassis	Takedown MOE retractable stock	Adjustable butt pad	Adjustable cheek rest	Adjustable length of pull	Bean bag rider	Buttstock spacer 1 1/16"	Monopod rail	Picatinny full length top rail for NVD	Low profile top rail	No top rail	Rubberized grip	Magazine sleeve*	Aluminium detachable base*	Polymer detachable base*	Centre bipod rail	Centre accessory rail kit (2)	Tube bipod rail	3" accessory rail	5" accessory rail	Bipod/Sling rail	Fore-end tube flush cup adaptor
Dual Strike (STKDL)	• Optional (folding)			•	•	•	Optional	Optional	•	•			•	•	•		Optional	Optional	•	•	•	•	•	•
Lite Strike (STKLT)	• Optional (folding)			•	•	•	Optional	Optional	•	•			•	•	•		Optional	Optional	•	•	•	•	•	•
Lite Competition (STKLCP)	• (folding)			•	•	•	Optional	Optional	•		Optional	•	•	•	•		Optional	Optional	Optional				•	
Field Tactical (STKFT)	• (fixed)			•	•	•	Optional	Optional	•	•			•	•	•		Optional	•	•	•	•	•	•	•
Field Competition (STKFCP)	• (fixed)			•	•	•	Optional	Optional	•		Optional	•	•		•		Optional	Optional				•		
NEW Field QD (STKFQD)			•			•			•				•	•	•		Optional	Optional	•	•	•	•	•	•
Strike Nuke (STKNUK)		•		•	•	(spacers)	Optional	Optional				•			• (fixed)			Optional	Optional			•	Optional	



LEFT HANDED MODELS

Available for Remington 700, Stiller, Tikka T3/T3X, Defiance, Xtreme and most Rem 700 clones. (See appropriate chassis spec chart)

LITE STRIKE

Same ultimate sniper rifle system as the Dual Strike model but with emphasis on weight reduction.

LITE COMPETITION

Designed to incorporate all features needed by competitive shooters.

FIELD TACTICAL

Rugged Law Enforcement sniper system with full rail capability and aluminum detachable base.

FIELD COMPETITION

Same amazing chassis as the Lite Competition but with a fixed stock.

DISCONTINUED BUT AVAILABLE ON REQUEST

URBAN STRIKE

Compact and ultra-light shooting platform perfect for urban sniping and varmint hunting.

TACTICAL CORE

Rugged, naked, and ready for customizing to shooter's preferences.

OT CORE

The OT Core is an open top chassis designed to fit actions featuring their proprietary top rail.

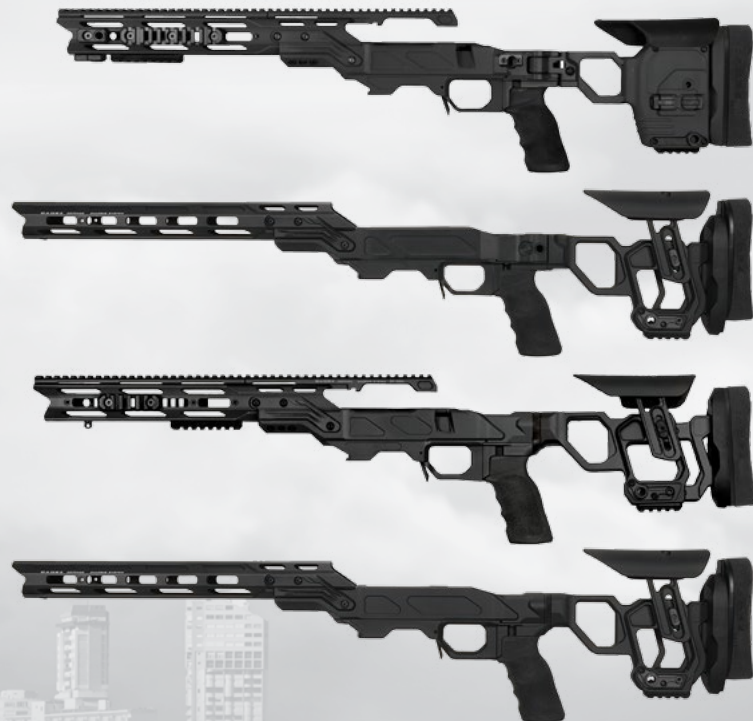

MODULAR SYSTEM

TRANSFORM YOUR HUNTING RIFLE INTO A PRECISION RIFLE

- Accuracy improvement
- Increased stability
- Fits any AR style buttstock
- Fits most AR style grips
- Detachable magazine
- Reduces felt recoil
- 20 MOA rail for long distance shots
- Improved ergonomics
- Multiple accessory rails



Example of compatible accessories

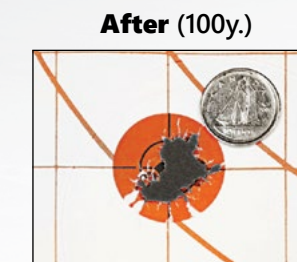

BUTTSTOCK FEATURES

TOOL-FREE ADJUSTABLE BUTTSTOCK



CADEX SKELETON STOCK

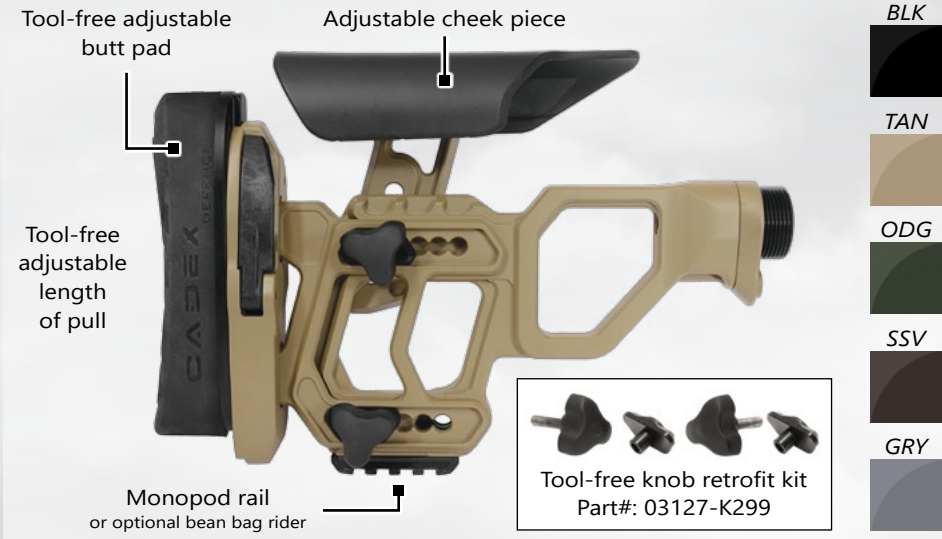

ACCESSORIES

CADEX RUBBERIZED GRIP

SPECIFICATIONS

Part#: 175-00088-BLK **NEW**
Dimensions: 3.38" x 1.8" x 4.13" | 8.59 x 4.57 x 10.49 cm
Material: Rubber
Weight: 0.2 lbs | 91 grams



Now featuring the new Cadex Defence logo

CADEX RECOIL PAD

SPECIFICATIONS

Part#: 175-00087-BLK **NEW**
Dimensions: 1.1" x 1.9" x 5.7" | 2.8 x 4.83 x 14.48 cm
Material: Rubber
Weight: 0.3 lbs | 136 grams



Now featuring the new Cadex Defence logo

AVAILABLE COLORS

PRECISION RIFLES		CHASSIS SYSTEM	
CERAKOTE COATINGS		SHERWIN-WILLIAMS	
BLK	C-102 GRAPHITE BLACK	BLK	POLANE DEAD FLAT BLACK F63B75301
TAN	H-257 TEXAS TAN	TAN	POLANE FLAT DARK EARTH F63TXH6123-8716
ODG	H-232 MAGPUL™ O.D. GREEN	ODG	POLANE O.D. GREEN F63TXG6099-8716
SSV	C-293 VORTEX BRONZE	CERAKOTE COATINGS	
GRY	H-234 SNIPER GREY	SSV	C-293 VORTEX BRONZE
		GRY	H-234 SNIPER GREY

HYBRID COLORS

(Action receiver, bolt and barrel black + chassis color of your choice)



Hybrid Tan/Black (HTB)



Hybrid Green/Black (HOD)



Hybrid Stealth Shadow (HSB)



Hybrid Grey/Black (HGB)



Black (BLK)



Tan (TAN)



O.D. Green (ODG)



Stealth Shadow Vortex (SSV)



Snipey Grey (GRY)

SNIPER DRAG BAG

SPECIFICATIONS

Drag bag 46" Part#: 175-00051

Dimensions interior:
45" x 12" x 3" | 114.3 x 30.48 x 7.62 cm

Dimensions exterior:
46" x 13.5" x 3.5" | 116.84 x 34.29 x 8.89 cm

Weight: 6.5 lbs | 2948 grams

SPECIFICATIONS

Drag bag 52" Part#: 175-00050

Dimensions interior:
51" x 12" x 3" | 129.54 x 30.48 x 7.62 cm

Dimensions exterior:
52" x 13.5" x 3.5" | 132.08 x 34.29 x 8.89 cm

Weight: 6.8 lbs | 3084 grams

SPECIFICATIONS

Drag bag 62" Part#: 175-00052

Dimensions interior:
60" x 12" x 3" | 152.4 x 30.48 x 7.62 cm

Dimensions exterior:
62" x 13.5" x 3.5" | 157.48 x 34.29 x 8.89 cm

Weight: 7.4 lbs | 3357 grams

FEATURES

- Accessory packs (for spare barrels, tooling, etc.)
- Heavy duty zipper.
- Double stitched reinforced seams.
- Reinforced carrying handle.
- Integrated backpack straps.
- Integrated tool pouch inside.
- Multiple Molle loops for attaching Camo or additional equipment.
- Attachment straps to secure the rifle.
- Protective hood and drag tether.
- 5" Velcro surface.
- Embroidered Cadex logo.



ACCESSORIES

PADDED RIFLE SLING

SPECIFICATIONS

Part#: 3850-K002

Dimensions:
39" x 1.57" x 0.2" | 99.06 x 3.9 x 0.5 cm

Dimensions extended:
63" x 1.57" x 0.2" | 160 x 3.9 x 0.5 cm

Weight: 0.4 lbs | 181 grams



CHAMBER FLAG

SPECIFICATIONS

Part#: 175-00075-FLG

Dimensions:
2.25" x 0.22" x 4.6"
5.71 x 0.56 x 11.68 cm

Weight: 0.011 lbs | 5 grams

Material: Plastic



HARD CASES

FEATURES:

- Impact-resistant NK7™ resin.
- Powerclaw latching system.
- Reinforced metal padlock holes. (Lock not included)
- Polyurethane wheels.
- Spring-loaded handles.
- Waterproof: IP67 rated.
- Temperature range:
Min -20°F (-29°C)
Max 140°F (60°C).

FEATURES:

- In-line skate style wheels for easy transport.
- Padlock holes include stainless steel padlock protector clips.
- Cushion grip handles on three sides for comfortable lifting and carrying.
- Waterproof and dust tight design (MIL-C-4150J).
- Molded-in hinge for added protection.
- Trigger release latch system.
- Ambient pressure equalization valve (MIL-STD-648C).
- Resistant to impact damage (MIL-STD-810F).

FOR CDX-30 / CDX-300 / CDX-338

Part#: 175-00057-TAN (without foam)
Part#: 175-00058-TAN (with cut-out foam)



FOR CDX-40 / CDX-50

Part#: 175-00066-BLK (without foam)
Part#: 175-00066-BLK-F40 (with cut-out foam)
Part#: 175-00066-BLK-F50 (with cut-out foam)



FOR CDX-MC KRAKEN

Part#: 175-00068-BLK (with cut-out foam)
*Picture may differ from actual product

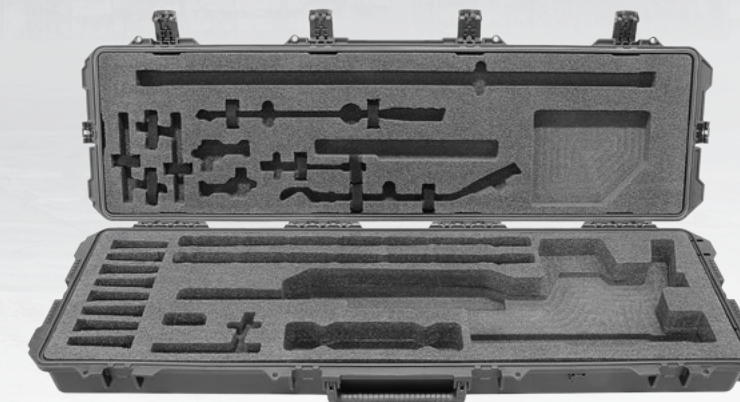

Cover holds:
Barrel change tool kit, cleaning rod, 3 bolts, 2 conversion kit

Bottom holds:
CDX-MC rifle, 8 magazines + 1 in the rifle, bipod, spare muzzle brake, suppressor, 2 spare barrels with muzzle brake

FALCON BIPOD

FALCON BIPOD

The Cadex Falcon Bipod has been designed to provide ultimate stability. It features multiple take down feet attachments such as claws or standard feet that adapt to any terrain. Can be installed on any rifle featuring a bipod rail.

FEATURES:

- Fast deployment legs without buttons to push.
- Ultra-tight machining tolerances for maximum stiffness and reduced free play.
- Reversible legs for choice of index or thumb push button operation.
- Easy to operate canting lever. Tilt angle + - 15.5°.
- Folds/deploys forward, rearward 45° or standard 90°.
- Standard feet, optional claws or optional spikes.
- Incredibly stable (width from 11" to 14.5").
- Designed to withstand recoil up to 50 BMG.
- Height adjustable from 6.25" to 8".



Long legs Falcon Bipod with universal Picatinny mount (#7431-K012LG)



Falcon Bipod with QD Picatinny mount (#7431-K015)



Folds forward and rearward



45° forward and rearward



90° shortened



90° extended

SPECIFICATIONS

Extension legs kit (+2" extra length)
Part#: 7431-K108

Dimensions:
0.93" x 0.93" x 2.5" | 2.36 x 2.36 x 6.35 cm

Weight: 0.16 lbs | 72 grams

Material: Aluminum 6061-T6 **NEW**



OPTIONAL FEET



Falcon Claws (#7431-K104)



Falcon Spikes (#7431-K106)



Falcon bipod shown with optional spikes



Falcon bipod shown with optional claws

SPECIFICATIONS

Falcon Bipod with universal Picatinny mount
Part#: 7431-K012

Falcon Bipod with QD Picatinny mount
Part#: 7431-K015

**All chassis and rifles with Picatinny rail*

Shortened: 11.12" x 5.19" x 6.28" | 28.24 x 13.19 x 15.95 cm

Extended: 12.99" x 5.19" x 7.9" | 32.99 x 13.19 x 20.07 cm

Folded: 8.81" x 5.01" x 1.76" | 22.38 x 12.74 x 4.47 cm

Weight: 1.34 lbs | 608 grams (+ 12 grams for QD)

Material: Aluminum 6061-T6

Universal Picatinny mount

QD Picatinny mount

SPECIFICATIONS

Long Legs Falcon Bipod with universal Picatinny mount Part#: 7431-K012LG **NEW**

Long Legs Falcon Bipod with QD Picatinny mount Part#: 7431-K015LG

**All chassis and rifles with Picatinny rail*

Shortened: 12.98" x 5.19" x 8.09" | 32.97 x 13.19 x 20.55 cm

Extended: 16.36" x 5.19" x 11.02" | 41.55 x 13.19 x 28 cm

Folded: 11.91" x 5.01" x 1.76" | 30.25 x 12.74 x 4.47 cm

Weight: 1.48 lbs | 671 grams (+ 12 grams for QD)

Material: Aluminum 6061-T6

Universal Picatinny mount

QD Picatinny mount

FALCON LITE BIPOD

The Falcon Lite bipod is the result of an extensive product development project for a military unit. Their snipers were in need of a light bipod, solid, stable and featuring both a panning and canting capability. At less than 400 grams, the Falcon Lite features a quick-detach (QD) Picatinny mount, a tensioning lever, telescopic aluminum tube legs and modular feet attachments. This bipod has a very wide footprint spread and some of the tightest machining tolerances on the market, making it the most stable lightweight bipod you'll find. The modular locking feet attachments are a must to adapt to any shooting surfaces.



QD Picatinny mount



SPECIFICATIONS

Falcon Lite Bipod Part#: 7431-K102

**All chassis and rifles with Picatinny rail*

Shortened: 10.53" x 3.31" x 6.24" | 26.76 x 8.4 x 15.91 cm

Extended: 13.55" x 3.31" x 8.88" | 32.99 x 8.4 x 22.56 cm

Folded: 8.43" x 4.49" x 1.74" | 21.41 x 11.41 x 4.41 cm

Weight: 0.88 lbs | 399 grams

Material: Aluminum 6061-T6

OPTIONAL FEET



Falcon Claws (#7431-K104)



Falcon Spikes (#7431-K106)



Includes a fast dismantle adapter capable of blocking the panning feature while maintaining the canting feature







Extension legs kit (#7431-K108)

Telescopic legs (9 positions)

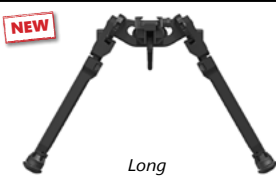

COMPARISON TABLE

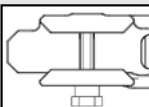
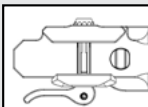
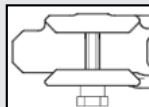
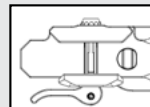
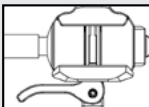
	FALCON BIPOD				FALCON LITE BIPOD
					
MOUNTING OPTIONS	Universal Picatinny mount 	QD Picatinny mount 	Universal Picatinny mount 	QD Picatinny mount 	QD Picatinny mount 
HEIGHT RANGE	7.70" - 10.63" (19.55 - 27 cm)	7.70" - 10.63" (19.55 - 27 cm)	6.28" - 7.90" (15.95 - 20.07 cm)	6.28" - 7.90" (15.95 - 20.07 cm)	6.24" - 8.88" (15.85 - 22.56 cm)
WEIGHT	1.40 lbs (636 grams)	1.43 lbs (647 grams)	1.34 lbs (608 grams)	1.37 lbs (620 grams)	0.88 lbs (399 grams)
OPTIONAL FEET	Claws - Spikes	Claws - Spikes	Claws - Spikes	Claws - Spikes	Claws - Spikes
90° FOOTPRINT SPREAD	12.9" - 16.35"	12.9" - 16.35"	11.4" - 13.27"	11.4" - 13.27"	10.5" - 13.54"
LEG POSITIONS (ANGLE)	0 - 45 - 90 - 135 - 180	0 - 45 - 90 - 135 - 180	0 - 45 - 90 - 135 - 180	0 - 45 - 90 - 135 - 180	0 - 45 - 90 - 135 - 180
TOTAL LEG POSITIONS (ANGLE)	5	5	5	5	5
TOTAL LEG POSITIONS (HEIGHT)	10	10	6	6	9
CANT ANGLE	+/- 15.5° (31° total)	+/- 15.5° (31° total)	+/- 15.5° (31° total)	+/- 15.5° (31° total)	+/- 13.5° (27° total)
PAN ANGLE	N/A	N/A	N/A	N/A	+/- 15° (30° total) (lockable)
MAIN MATERIAL	Aluminum 6061-T6	Aluminum 6061-T6	Aluminum 6061-T6	Aluminum 6061-T6	Aluminum 6061-T6
PART NUMBER	7431-K012LG	7431-K015LG	7431-K012 (Replaces 7431-K002)	7431-K015	7431-K102

MODULAR PICATINNY RAILS



3" and 5" Modular Picatinny rails and 3.5" bipod rail are designed to fit on Cadex modular products such as rifles, chassis and shotgun accessories.

FEATURES:

- Ultra-solid 6061-T6 aluminum.
- Rugged lightweight construction.
- The Modular Picatinny rail fits on Strike Chassis, 870 Modular Fore-end Pump Guard and more.
- Mounting screws included.

SPECIFICATIONS

3.5" bipod rail

Part#: 03127-A002

Dimensions:

3.43" x 0.83" x 0.48" | 8.7 x 2.11 x 1.22 cm

Weight: 0.07 lbs | 31 grams

Material: Aluminum 6061-T6

SPECIFICATIONS

3" Modular Picatinny rail

Part#: 03127-A078

Dimensions:

3.01" x 0.83" x 0.37" | 7.66 x 2.12 x 0.96 cm

Weight: 0.05 lbs | 22 grams

Material: Aluminum 6061-T6

SPECIFICATIONS

5" Modular Picatinny rail

Part#: 03127-A017

Dimensions:

4.90" x 0.83" x 0.37" | 12.46 x 2.12 x 0.96 cm

Weight: 0.07 lbs | 31 grams

Material: Aluminum 6061-T6

9" BIPOD RAIL



The Cadex 9" bipod rail allows more mounting positions than a conventional 3.5" bipod rail. It fits most of our chassis and rifle models. Can also be mounted on the side of Cadex rifles and chassis featuring 5 mounting screws.

COMPATIBLE WITH :

CDX-MC Kraken, CDX-33 Patriot, CDX-300 Freedom and CDX-30 Guardian rifles. The Dual Strike (not 50 BMG), Lite Strike, Field Tactical and Tactical Core chassis.

Also fit non M-LOK generation of CDX-R7 Lite Comp, CDX-R7 Field Comp, CDX-R7 Shepherd & Sheepdog rifles and Lite Competition, Field Competition chassis. (Prior to 2018 models)

SPECIFICATIONS

9" bipod rail Part#: 03127-K015

Dimensions:

9.3" x 0.87" x 0.37" | 23.62 x 2.2 x 0.94 cm

Weight: 0.14 lbs | 63 grams

Material: Aluminum 6061-T6

M-LOK RAILS



NEW 2019

With the growing popularity of PRS style shooting competitions came a huge selection of aftermarket accessories using the M-LOK technology. With more possible positioning than any other system, the M-LOK system offers a true benefit for the competition shooter and this is why for 2019 Cadex decided to incorporate this technology to some of its most popular models.

From now on, all products featuring an M-LOK logo next to their names will feature this technology. The M-LOK system isn't compatible with Cadex's previous screw pattern, rails and accessories so make sure to order M-LOK accessories if your chassis or rifle features the M-LOK technology.



INSTALL/UNINSTALL

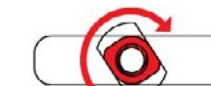

TIGHTEN



T-NUT LOCKED

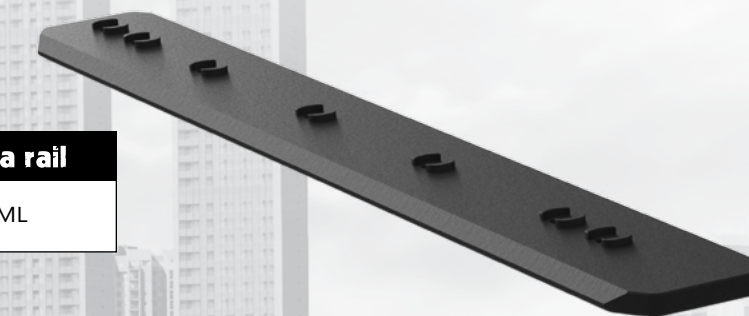

M-LOK 12.5" Arca rail

Part#: 03127-959ML



M-LOK Flush cup adaptor

Part#: 03127-A174ML



M-LOK 3" accessory rail

Part#: 03127-A078ML



M-LOK 3.5" aluminum bipod rail

Part#: 03127-A002ML



M-LOK 5" accessory rail

Part#: 03127-A017ML



M-LOK 9" bipod rail

Part#: 03127-K015ML

NEW 2019

TRIPOD ADAPTORS

SPECIFICATIONS

Arca Tripod Adaptor
Part#: 03127-960-K1

Dimensions:
2.1" x 1.5" x 0.21" | 5.33 x 3.81 x 0.53 cm

Weight: 0.07 lbs | 30 grams

Material: Aluminum 6061-T6

SPECIFICATIONS

RC2 Tripod Adaptor
Part#: 03127-962-K1

Dimensions:
2.1" x 1.68" x 0.38" | 5.33 x 4.27 x 0.97 cm

Weight: 0.12 lbs | 56 grams

Material: Aluminum 6061-T6

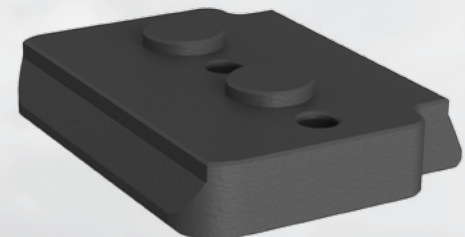
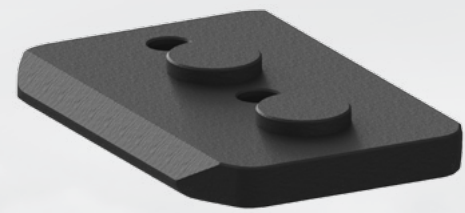

PRS shooters and snipers share the same challenge in the field. Finding a stable shooting position is often impossible and this is when a ruggedized tripod is a must.

The Cadex Arca & RC2 Adaptors bolt on the lower receiver of most of our rifles and chassis to perfectly balance them on the tripod. When prone isn't an option, this is the way to go.

**It is critical to use a tripod and tripod head capable to support the weight of the rifle.*



M-LOK ARCA RAIL

NEW 2019

SPECIFICATIONS

M-LOK Arca rail
Part#: 03127-959ML

Dimensions:
12.47" x 1.5" x 0.26" | 31.67 x 3.81 x 0.66 cm

Weight: 0.32 lbs | 149 grams

Material: Aluminum 6061-T6

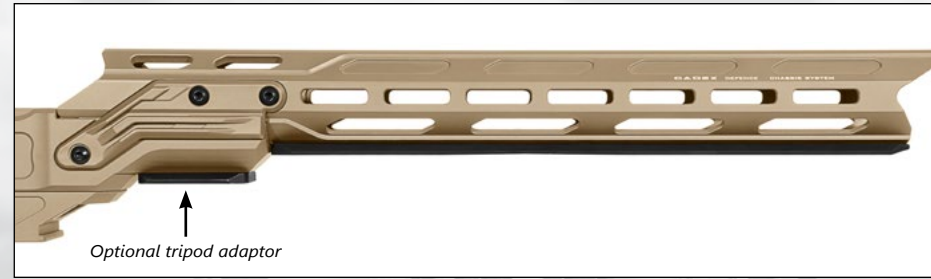

MORE COMPETITION ACCESSORIES UNDER DEVELOPMENT

- Arca Bipod Adaptor
- Arca Barricade Stop
- ELR Bag Rider
- Spare Round Carrier
- Bean Bag

CDX BORE GUIDES

SPECIFICATIONS

CDX-R7
Part#: BG-R7

CDX-30/300/33
Part#: BG-30-300-33

CDX-MC KRAKEN
Part#: BG-MC

CDX-40
Part#: BG-40

CDX-50
Part#: BG-50

Materials: Delrin & Aluminum 6061-T6

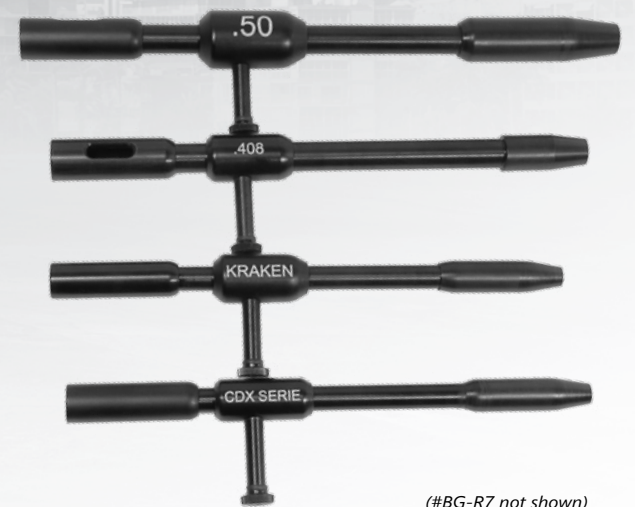

(#BG-R7 not shown)

NEW 2019

BOTTOM METAL

BOTTOM METAL

SPECIFICATIONS

Bottom Metal for:
R7 Sheepdog short action
Mag type: AICS
Model: DSSF 3.055"
 Part#: BMR7-DSSF-3055

R7 Shepherd long action
Mag type: AICS
Model: SSSF 3.715" to 3.850"
(adjustable)
 Part#: BMR7-SSSF-3850

CDX-R7 BOTTOM METAL



Compatible magazines (short action):
 Accurate mag 00100-0037 / 00100-0041 / 00100-0040 / 00100-0008

Compatible magazines (long action):
 Accurate mag 00100-0001 / 00100-0023 / 00100-0044 / 00100-00022

*Pillars included
 *Also fit Accuracy International AICS and Magpul PMAG

SPECIFICATIONS

Bottom Metal for:
CDX-30 Guardian action
Mag type: AICS
Model: DSSF 3.055"
 Part#: BMCDX-DSSF-3055

CDX-300 Freedom & CDX-33 Patriot actions
Mag type: AICS
Model: SSSF 3.715" to 3.850"
(adjustable)
 Part#: BMCDX-SSSF-3850

CDX-30/300/33 BOTTOM METAL



Compatible magazines (short action):
 Accurate mag 00100-0037 / 00100-0041 / 00100-0040 / 00100-0008

Compatible magazines (long action):
 Accurate mag 00100-0001 / 00100-0023 / 00100-0044 / 00100-00022

*Pillars included
 *Also fit Accuracy International AICS and Magpul PMAG

SPECIFICATIONS

Bottom Metal for:
CDX-40 Shadow action (375/408 CT)
Mag type: Cadex
Model: SSSF 4.725"
 (replaces 03127-A087-K1)

Stiller Tac408 (1.45" and 1.60") and J.J. Rock actions
Mag type: Cadex
Model: SSSF 4.725"
 Part#: 03127-A086-K1

CDX-40 BOTTOM METAL

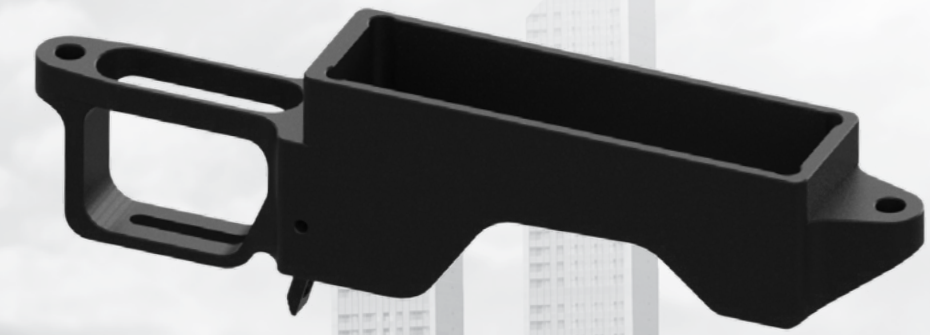

Compatible magazine:
 MAG 4300 (see specs p.63)

*Pillars included

SPECIFICATIONS

Bottom Metal for:
CDX-50 Tremor action
Mag type: MAG 2949
Model: SSSF 5.790"
 Part#: BMCDX-SSSF-5790

CDX-50 BOTTOM METAL

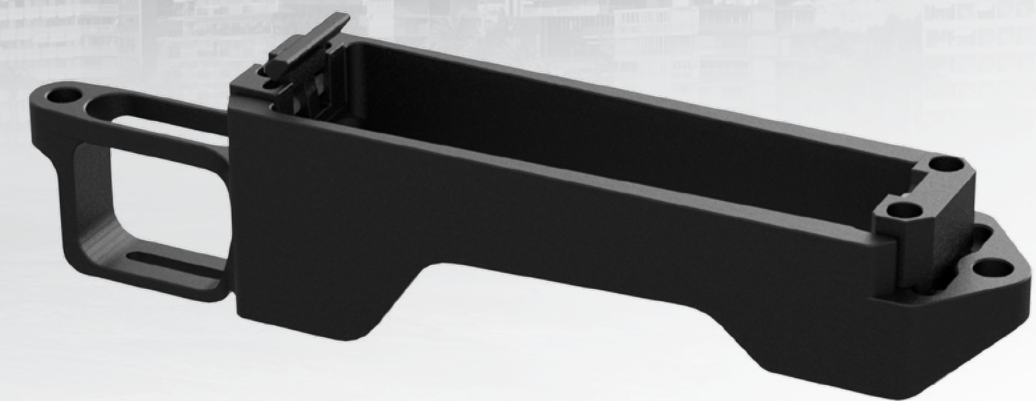

Compatible magazine:
 MAG 2949 (see specs p.63)

*Pillars included



MULTI-CALIBER MAGAZINES



- Military grade magazines.
- Solid anti-corrosion coating.
- Rigid steel mag body.
- Easy to clean.

- .223 magazines also fit .204 Ruger, 6.8 SPC, .300 Blackout/Whisper
- .308 magazines also fit .22-250 Rem, .243 Win, 6 Creedmoor, .260 Rem, 6.5 Grendel/Creedmoor, 6.5 x 47 Lapua
- .300 WSM magazines also fit 270 WSM
- .300 magazines also fit 7mm Rem Mag
- .30-06 magazines can also fit .308 Win fitted with VLD bullets

PART #	CALIBER	ACTION	TYPE	INTERNAL LENGTH	LENGTH	CAPACITY
MAG100-0037	.223 REM	Short	DSSF	2.990"	3.055"	10
MAG100-0041	.308 WIN	Short	DSSF	2.990"	3.055"	5
MAG100-0040	.308 WIN	Short	DSSF	2.990"	3.055"	10
MAG100-0008	.300 WSM	Short	DSSF	2.990"	3.055"	7
MAG100-0039	.30-06 SPRG	Long	SSSF	3.640"	3.715"	5
MAG100-0001	.300 WM	Long	SSSF	3.640"	3.715"	5
MAG100-0004	.300 WM	Long	SSSF	3.700"	3.775"	5
MAG100-0023	.300 WM	Long	SSSF	3.755"	3.850"	5
MAG100-0044	.300 RUM	Long	SSSF	3.640"	3.715"	5
MAG100-0003	.338 LAP	Long	SSSF	3.640"	3.715"	5
MAG100-0005	.338 LAP	Long	SSSF	3.700"	3.775"	5
MAG100-0022	.338 LAP	Long	SSSF	3.775"	3.850"	5
MAG100-0020	.338 LAP	Long	DSSF	3.775"	3.850"	5
MAG100-0086	.338 LAP	Long	DSSF	3.775"	3.850"	10

NEW

**Might also fit other specialty calibers with minor modifications*

ACCURATE - MAG

CADEX MAGAZINES



Part#: MAG4300
(for CDX-40 or Stiller Tac 408)

Part#: MAG2949
(for CDX-50 or PGWDTI LRT3)

Double Stack
Part#: MAG2538D
(for McMillan Tac 50)



- The extra wide bottom plate assists in magazine manipulation.
- Rigid magazine body made of metal with an anti-corrosion coating.
 - Injection molded follower and bottom plate.
 - Easy to clean.

PART #	CALIBER	ACTION	TYPE	INTERNAL LENGTH	LENGTH	CAPACITY
MAG4300	.375/408 CT	CDX-40	DSSF	4.625"	4.725"	7
MAG2949	.50 BMG	CDX-50	SSSF	5.520"	5.790"	5
MAG2538D	.50 BMG	CDX-50	DSDF	5.645"	5.790"	5

UNITIZED SCOPE RINGS

Cadex's Unitized Scope Rings provide a rock solid mount for sniper optics, with multiple applications for flat-top ARs and bolt action rifles.

FEATURES:

- CNC machined for precise alignment of the front and rear scope bearing surfaces.
- The base incorporates high grade cross lugs and nuts to secure the mount to the weapon rail.
- The dovetail is machined to fit all Mil Std M1913 rails.
- Unitized body ensures that the scope is secure with no twisting of the optical tube assembly and no shifting under heavy recoil.
- Customers may request different ring diameters and heights to fill their particular requirements.

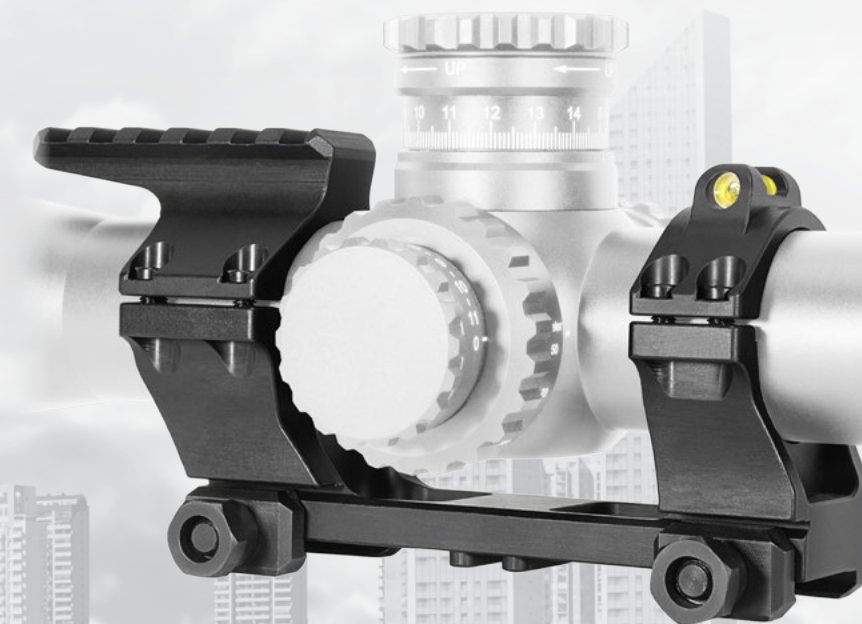

Standard rear



R130 (30mm) | R134 (34mm)
R135 (35mm)

Bubble level rear



R230 (30mm) | R234 (34mm)
R235 (35mm)

BASE PART #	HEIGHT	DIAMETER	TYPE
1552-B30L	1.250"	30mm	LOW
1552-B30H	1.500"	30mm	HIGH
1552-B34L	1.250"	34mm	LOW
1552-B34H	1.500"	34mm	HIGH
1552-B35H	1.500"	35mm	HIGH

NEW

Standard front



F130 (30mm) | F134 (34mm)
F135 (35mm)

Top rail high front



F230H (30mm) | F234H (34mm)

Side rail front



F330 (30mm) | F334 (34mm)

Docter mount with Simrad front



F430 (30mm) | F434 (34mm)

CUSTOMIZE YOUR SCOPE MOUNT

Step 1: Select your base Step 2: Select your rear top Step 3: Select your front top

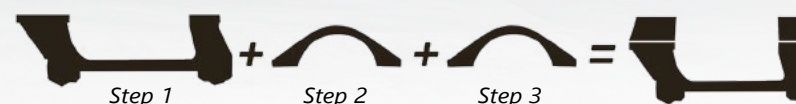

CHASSIS HARDWARE

 <p>CADEX DEFENCE UNIVERSAL CHASSIS SCREW KIT</p>		
<p>BIPOD RAIL ASSY. 2 X P/N: 100-00076 Ref. Manual Annexe L Detail D BIPOD ATTACHMENT 1 X P/N: 03127-322</p>	<p>BOTTOM TUBE ASSY. 2 X P/N: 100-00143 Ref. Manual Fig. 16 & 19</p>	<p>MODULAR RAILS & TUBE SLING ASSY. 6 X P/N: 100-00076 Ref. Manual Annexe L Detail D</p>
<p>SIDE PLATES ASSY. 2 X P/N: 100-00143 4 X P/N: 100-00222 Ref. Manual Fig. 15</p>	<p>ERGO GRIP ASSY. 1 X INCLUDE WASHER & TOOTH WASHER P/N: 100-00026</p>	<p>TOP RAIL KIT 4 X (6-48 X 3/8) P/N:100-01209 4 X (8-40 X 3/8) P/N:100-00140 Ref. Manual Fig. 17</p>

SPECIFICATIONS

Universal Screw Kit

Part#: 03127-K013

Material: Blackened Stainless

The Chassis Universal Screw kit contains an assortment of replacement screws to revamp your chassis. If your chassis has seen better days and you'd like to refresh its hardware then this kit is what you are looking for. Contains enough screws to outfit any Cadex Strike chassis.

CONTAINS:

- 2x Bipod rail screws
- 1x Bipod/Sling stud
- 2x Fore-end tube assy screws
- 8x Modular rail screws
- 4x Side plate/Boomerang screws (long)
- 6x Side plate/Boomerang screws (short)
- 1x Grip assy washers and screws
- 4x #6-48 top rail screws
- 4x #8-40 top rail screws

You went too fast and cross-threaded a screw? You didn't respected the recommended torque and broke a Time-Sert? This kit is for you.

INCLUDES:

- 1x Time-Sert extractor
- 1x Time-Sert driver
- 6x Short Time-Serts
- 6x Long Time-Serts

*Red Loctite highly recommended (not included)

You are mechanical inclined and wish to add some Time-Serts where it wasn't designed for? You'll also need:

NOT INCLUDED:

- 1x Drill #21
- 1x Helicoil Tap 10-32

NEW 2019

SPECIFICATIONS

Time-Sert Repair Kit

Part#: 03127-K029

Material: Stainless

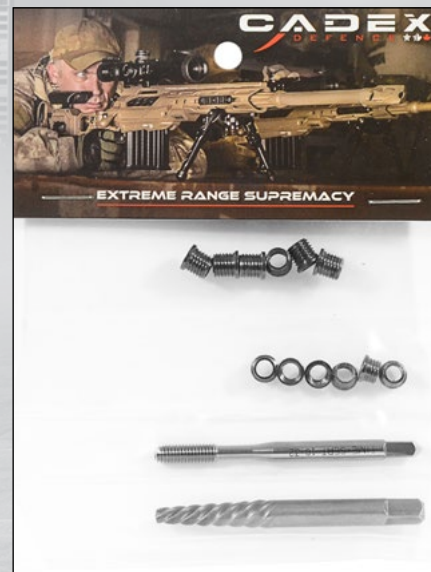

SLING MOUNTS

SPECIFICATIONS

Monopod rail with flush cup

Part#: 03127-A173

Dimensions:

2.64" x 0.83" x 0.43" | 6.71 x 2.11 x 1.09 cm

Weight: 0.053 lbs | 24 grams

Material: Aluminum 6061-T6

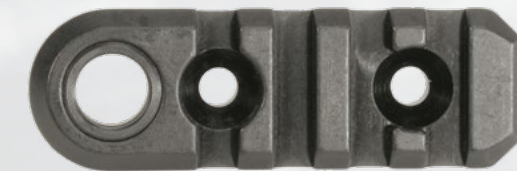

SPECIFICATIONS

Flush cup sling adaptor

Part#: 03127-A174

Dimensions:

1.44" x 0.75" x 0.33" | 3.67 x 1.91 x 0.86 cm

Weight: 0.029 lbs | 13 grams

Material: Aluminum 6061-T6

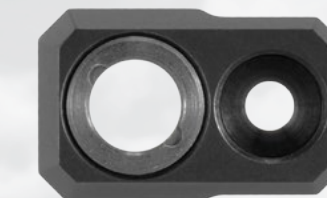

SPECIFICATIONS

Small Picatinny sling adaptor

Part#: 1757

Dimensions:

1.53" x 0.62" x 0.75" | 3.89 x 1.58 x 1.91 cm

Weight: 0.029 lbs | 13 grams

Material: Aluminum 6061-T6



SPECIFICATIONS

VTAC L.U.S.A 4 point sling adaptor

Part#: 1398 (NSN: 1005-01-561-0488)

Dimensions:

1.52" x 1.33" x 0.75" | 3.86 x 3.4 x 1.91 cm

Weight: 0.051 lbs | 23 grams

Material: Aluminum 6061-T6



The Cadex quick-detachable sling swivel mounts accept all common types of push button QD swivels available on the market. They are versatile mounts that allow shooters to vary the location of the sling attachment on their weapon.

FEATURES:

- Fits all Mil Std quick-release sling swivels.
- Attaches to Mil Std M1913 rails.
- Compact size.
- VTAC L.U.S.A. four sling attachment methods:
 - Passing the sling through the sling loop
 - HK hooks and similar quick-release devices
 - Push button type quick-release sling swivels
 - Locking type sling swivels for sling studs



Flush cup sling adaptors to be used with standard push button swivel attachments



GLASS PUNCH

The Cadex Glass Punch provides users with a rapid means of breaking glass under different tactical conditions. Installs on firearms equipped with Mil Std M1913 rails. The punch's length ensures it will protrude forward of the firearm muzzle.

FEATURES:

- Prevents the need to transition to a hand held punch and side-arm.
- Permits the operator to keep two hands on their firearm.
- Incorporates a spring-loaded hammer mechanism activated by pressing the punch against the glass.
- Perfect for short barrel carbines.



SPECIFICATIONS

Glass Punch

Part#: 1185

Dimensions:

7.27" x 1.68" x 1.03" | 18.48 x 4.27 x 2.62 cm

Weight: 0.36 lbs | 165 grams

Material: Aluminum 6061-T6

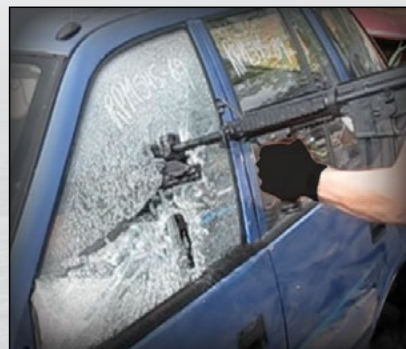

CARBINE PICATINNY RAILS

The Cadex 4.2" and 6" Carbine Picatinny Rails attach to the handguard of the M4/C8 Carbine or M16/C7 rifle to provide a sturdy Picatinny rail for mounting grips, lasers, and other accessories. Fit also AR15 equipped with A2 handguard.

FEATURES:

- Rails can be installed on the top and bottom of the handguard to provide multiple mounting points.
- The rail's base is angled to match the handguard taper.
- Made from Lightweight aluminum.



SPECIFICATIONS

4.2" Picatinny rail

Part#: CMR-418-01

Dimensions:

4.2" x 0.83" x 0.56" | 10.66 x 2.11 x 1.43 cm

Weight: 0.07 lbs | 32 grams

Material: Aluminum 6061-T6

SPECIFICATIONS

6" Picatinny rail

Part#: CMR-418-02

Dimensions:

6" x 0.83" x 0.56" | 15.24 x 2.11 x 1.43 cm

Weight: 0.09 lbs | 43 grams

Material: Aluminum 6061-T6

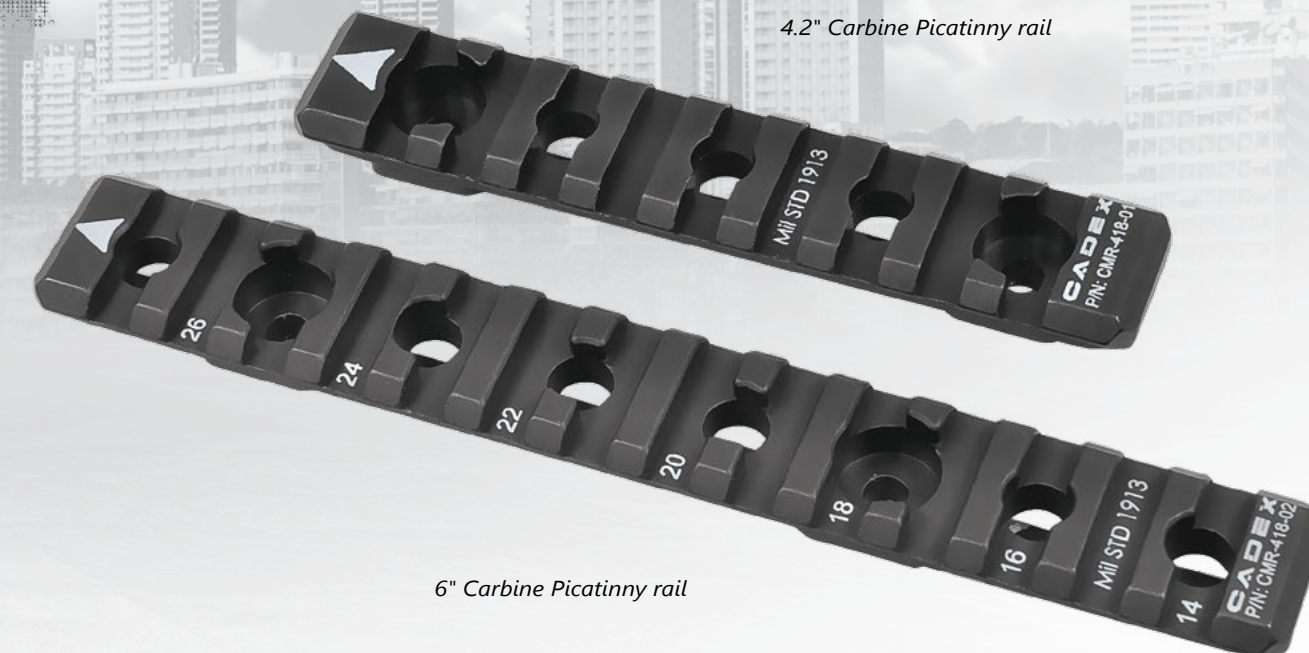

4.2" Carbine Picatinny rail

6" Carbine Picatinny rail

MP5 FORE-END RAIL



The Cadex MP5 Fore-end Rail provides the operator with a solid base to accessorize the Heckler & Koch MP5.

FEATURES:

- Three M1913 mounting rails, at 3, 6, and 9 o'clock.
- Provides rigid mounting for lights, lasers, and other accessories.
- Easy installation using existing mounting holes.

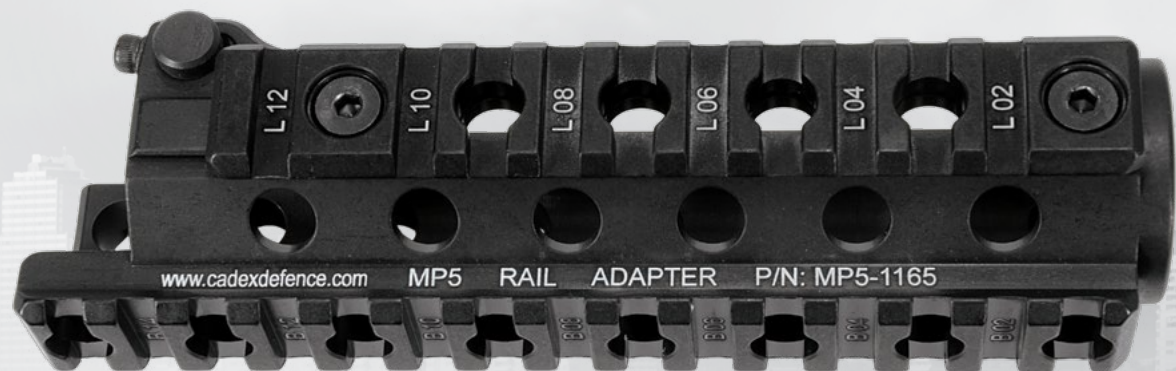

SPECIFICATIONS

MP5 Fore-end Rail
Part#: 1165
Dimensions:
3.94" x 2" x 1.78" | 10.03 x 5.1 x 4.52 cm
Weight: 0.27 lbs | 124 grams
Material: Aluminum 6061-T6

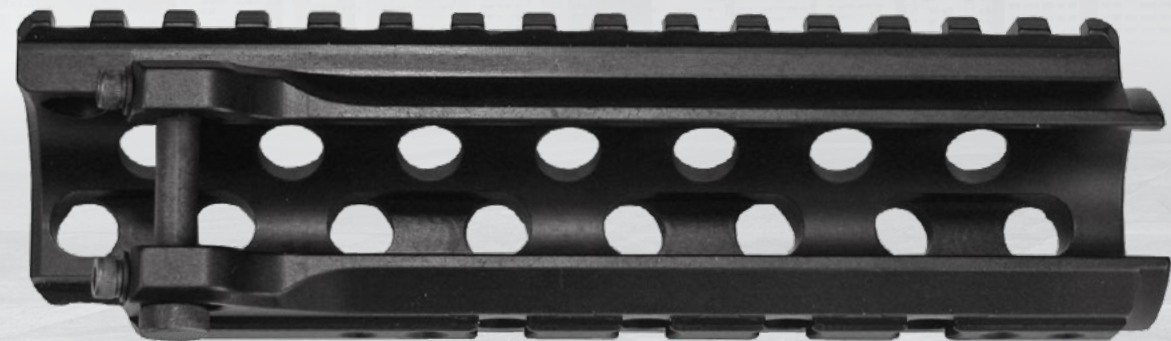

ACCURACY
INTERNATIONAL
AW/AICS

FORE-END RAIL

The Cadex Fore-end Rail provides users of the Accuracy International Rifle or chassis with a world-class mount for inline night vision, lasers, and accessories. Designed for the Accuracy International Chassis System (AICS), it provides Mil Std M1913 rails at the 3, 9, and 12 o'clock position.

FEATURES:

- Permits the sniper to install/remove night vision devices without adjusting zero of their primary sniper optic.
- Places the sniper optic and attached night vision on the same plane.
- Side rails provide excellent zero retention of side-mounted laser.
- 0 MOA is standard, but other MOAs are also available on special run.
- Rail interfaces for Remington 700 mounted in the AICS are available upon request.

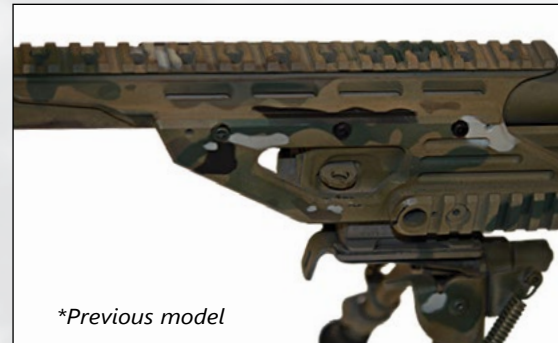

SPECIFICATIONS

Accuracy International Fore-end Rail Part#: 1272-A002
Dimensions:
11.81" x 3.34" x 2.72" | 30 x 8.5 x 6.9 cm
Weight: 1.09 lbs | 496 grams
Material: Aluminum 6061-T6



TRI-RAIL MOUNT



**Individually removable rails*

The Cadex Tri-Rail Mount for the C7/C8, M4/M16 and AR-15 family of small arms provides users with a robust mount for laser pointers, illumination devices, and bipods. Mil Std 1913 rails at the 3, 6 and 9 o'clock positions.

FEATURES:

- The rail reduces heat transferred to attached electro-optics.
- Installation requires no modifications to the weapon.
- Removable rails permit the user to reduce the weapon's weight and profile, according to their mission.

SPECIFICATIONS

C7/C8 & M4/M16 Tri-Rail Mount

Part#: 1220

Dimensions:

3.33" x 2.92" x 2.83" | 8.47 x 7.42 x 7.21 cm

Weight: 0.37 lbs | 166 grams

Material: Aluminum 6061-T6



M4 EXTENDED FORE-END RAIL



The Cadex M4 Extended Fore-end Rail provides the user with a world-class mount. It is a light and strong rail system. The Cadex rail extension system is produced out of one solid piece of aluminum 6061-T6 and designed for toughness and durability. Its ergonomic design, with multiple rail configurations, allows for great maneuverability and precision improvement. It meets the Mil Std M1913 for rails.

FEATURES:

- Fits on Knight's Armament model. May fit other AR models but we can't guarantee a perfect fit.
- 2 built-in flush cups.
- Full floating rail extension.
- One piece design for toughness and durability.
- Multiple end rail position configurations.
- Ergonomic design for maneuverability improvement.
- Allows the operator to extend the handle grip position on the fore-end of the rifle.

SPECIFICATIONS

M4 Extended Rail

Part#: 4093

Dimensions:

6.34" x 2.19" x 2.3" | 16.1 x 5.56 x 5.84 cm

Weight: 0.6 lbs | 271 grams

Material: Aluminum 6061-T6



**Fits on Knight's Armament model. May fit other AR models but we can't guarantee a perfect fit.*

FOLDING & STUBBY GRIP

SPECIFICATIONS

Folding grip Part#: 622-000-BLK
622-000-TAN • 622-000-ODG

Dimensions:
2.81" x 1.67" x 5.62" | 7.16 x 4.26 x 14.28 cm

Dimensions folded:
2.4" x 1.67" x 5.68" | 6.09 x 4.26 x 14.42 cm

Weight: 0.29 lbs | 131 grams

Material: Nylon



The Cadex Vertical Folding Grip and Stubby Grip provide the operator with a weapon hold that is adaptable to changing tactical conditions.

FEATURES:

- Folds parallel to the barrel to be more compact and provide multiple hand hold options.
- Fits Mil Std 1913 and Weaver rails.
- Comes in Black, OD Green and Tan.
- Rattle proof self-draining storage compartment for 2 X CR123 (Folding) and 1 x CR123 (Stubby) batteries.
- Ambidextrous design.
- Solid and lightweight.

SPECIFICATIONS

Stubby grip
Part#: 1979-BLK • 1979-TAN • 1979-ODG

Dimensions:
2.76" x 1.7" x 3.83" | 7.01 x 4.32 x 9.73 cm

Weight: 0.21 lbs | 95 grams

Material: Nylon



AR10/AR15 RECEIVER

NOT AVAILABLE IN THE USA

Cadex's AR10 and AR15 lower Receivers are manufactured to fit Armalite & Noveske upper receiver assemblies. They are precision machined from aeronautical grade 7075-T6 aluminum to provide the user with a high quality lower receiver for their AR10 (B series only) or AR15 rifle.

FEATURES:

- Interchangeable with high quality AR10 (B series only) or AR15 parts.
- The magazine well opening is extended with a large bevel that provides a guide for easier magazine insertion.
- Machined ribs at the front of the magazine well for a secure grip.
- Oversized trigger guard.

SPECIFICATIONS

AR10 (B series only) Part#: 1570-003

Dimensions:
8.96" x 1.59" x 4.34" | 22.77 x 4.06 x 11.03 cm

Weight: 0.74 lbs | 336 grams

Material: Aluminum 7075-T6

SPECIFICATIONS

AR15 Part#: 1570-001

Dimensions:
7.69" x 1.45" x 4.11" | 19.54 x 3.7 x 10.45 cm

Weight: 0.58 lbs | 264 grams

Material: Aluminum 7075-T6

MACHINED FROM A SOLID ALUMINUM BILLET
NO CASTING



AR10 Receiver
(B series only - Designed to fit M14 magazines)

AR15 Receiver



SHOTGUN BUTTSTOCK ADAPTOR

OPTIC MOUNTS

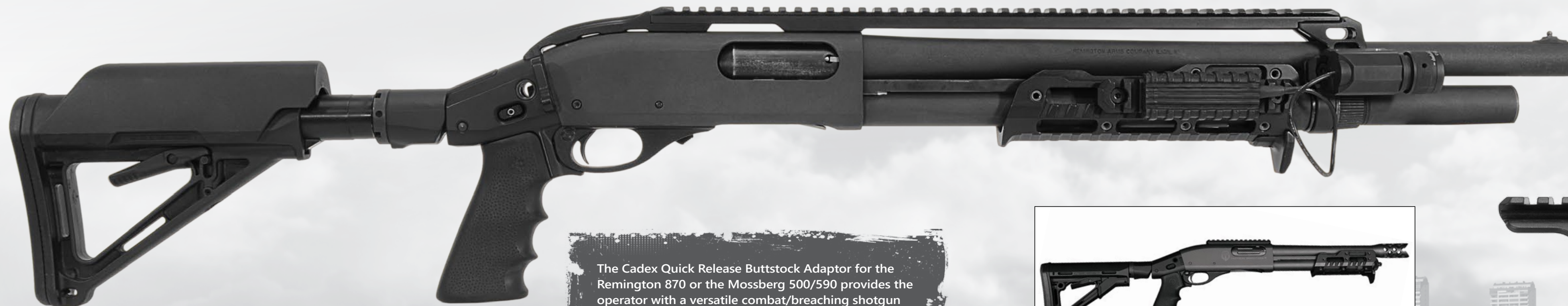

SPECIFICATIONS

Mossberg Saddle mount NEW
 Part#: 6381-TR002

Dimensions:
 6.93" x 1.74" x 2.49" | 17.6 x 4.42 x 6.32 cm

Weight: 0.28 lbs | 127 grams

Material: Aluminum & Stainless Steel

The Cadex Quick Release Buttstock Adaptor for the Remington 870 or the Mossberg 500/590 provides the operator with a versatile combat/breaching shotgun combination in one weapon.

FEATURES:

- Allows the shotgun to be quickly configured as a combat or breaching shotgun.
- The buttstock release is a push button mechanism which provides positive locking of the buttstock with no excess movement.



SPECIFICATIONS

870 Top Rail Part#: 1486-A010

Dimensions:
 20.88" x 2.17" x 3.13" | 53.04 x 5.51 x 7.95 cm

Weight: 0.73 lbs | 330 grams

Material: Aluminum 6061-T6



Cadex's rail system takes the Remington 870 shotgun to a new level of versatility, providing a mounting platform that tailors the shotgun to the mission.

FEATURES:

- The Mil Std M1913 rails permit the mounting of red dot sights so the shooter can engage targets quickly and accurately.
- Different combinations of iron sights and mini red dot sights can be mounted to achieve a co-witnessed installation.
- Two side rails are included for mounting lasers or other accessories such as any of Cadex's Sling Mounts or Flashlight Mounts.



SPECIFICATIONS

870 Tactical Buttstock Adaptor
 Part#: LB-1486

Dimensions:
 4.66" x 1.35" x 3.23" | 11.84 x 3.43 x 8.22 cm

Weight: 0.62 lbs | 280 grams

Dimensions with sling mount:
 4.66" x 2.02" x 3.23" | 11.84 x 5.13 x 8.22 cm

Material: Aluminum & Stainless Steel

Quick Detach

SPECIFICATIONS

870 Fixed Buttstock Adaptor
 Part#: 1486-037

Dimensions:
 3.45" x 1.35" x 3.24" | 8.76 x 4.87 x 8.23 cm

Weight: 0.49 lbs | 220 grams

Dimensions with sling mount:
 3.45" x 2.02" x 3.24" | 8.76 x 5.13 x 8.23 cm

Material: Aluminum & Stainless Steel

Fixed buttstock adaptor also available

SPECIFICATIONS

Mossberg 500/590 Tactical Buttstock Adaptor Part#: LB-6381

Dimensions:
 5.29" x 1.46" x 3.26" | 13.44 x 3.71 x 8.28 cm

Weight: 0.57 lbs | 259 grams

Dimensions with sling mount:
 5.29" x 2.13" x 3.26" | 13.44 x 5.41 x 8.28 cm

Material: Aluminum & Stainless Steel

NEW

MAG CAP DUAL RAIL



SPECIFICATIONS

Mag Cap Dual Rail

Part#: 1486-A012

Dimensions:

1.58" x 2.17" x 1.96" | 4.01 x 5.51 x 4.98 cm

Weight: 0.22 lbs | 101 grams

Material: Aluminum 6061-T6



Cadex's rail system greatly improves effectiveness of the Remington 870 shotgun, providing a mounting platform which allows users to tailor the shotgun to the mission. The twin M1913 rails permit mounting of flashlights and lasers providing stability and focus when cycling the action of the shotgun.

FEATURES:

- Reuses the original 870 mag cap.
- Twin M1913 Rails.
- Mounts in conjunction with the barrel lug and magazine cap, no modification required.
- Users can install accessories such as Sling Mounts or Flashlight Mount.

PICATINNY

HAND STOP



SPECIFICATIONS

Hand Stop Part#: 1164

Dimensions:

1.5" x 0.62" x 1.74" | 3.81 x 1.57 x 4.42 cm

Weight: 0.07 lbs | 31 grams

Material: Aluminum 6061-T6

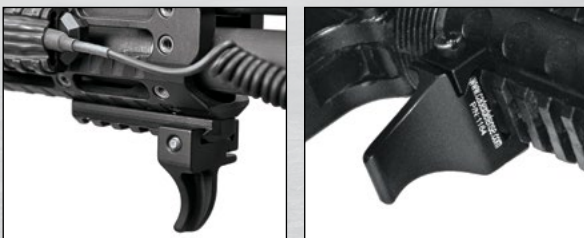

The Cadex Hand Stop enhances safe handling of short barreled weapons by preventing the operator's lead hand from moving forward of the muzzle. It also optimizes weapon control and accuracy by providing a tactile indicator of hand position, which permits a repeatable weapon hold.

FEATURES:

- Adaptable to both Mil Std M1913 and Weaver rails.
- Assists positive retention of the weapon for maximum muzzle control during rapid fire.
- Perfect for shotgun and carbine.

FORE-END PUMP

Customize your own Shotgun Modular Fore-End Pump

The Cadex Modular Fore-end Pump made from 6061-T6 corrosion resistant aluminum offers a world class ergonomic design allowing you to retrofit most Remington 870 or Mossberg 500/590 pump handle. 24 threaded inserts allow for multiple rail placements in order to customize your shotgun the way you like it.

FEATURES:

- Made out of aluminum 6061-T6 for maximum resistance.
- Multiple rail positions.
- Ergonomic design.
- Allows you to retrofit easily any hand guard of Remington 870 shotgun.
- Fits from 0 to 7 rails.

SPECIFICATIONS

Modular Fore-End Pump

Part#: 4197

Dimensions:

7.02" x 1.85" x 2.42" | 17.83 x 4.72 x 6.15 cm

Weight: 0.64 lbs | 291 grams

Material: Aluminum 6061-T6



**Shown with optional accessories*

SPECIFICATIONS

Mossberg 500/590

Fore-End Pump Part#: 6381



Dimensions:

8.75" x 1.8" x 2.09" | 22.23 x 4.57 x 5.31 cm

Weight: 0.63 lbs | 285 grams

Material: Aluminum 6061-T6



**Shown with optional 3" & 5" accessory rails*

Optional rails and sling system attachment



5" Part#: 03127-A017



3" Part#: 03127-A078



Part#: 03127-A174

870 MCS Modular Fore-end Pump also available (Part#: 5181)

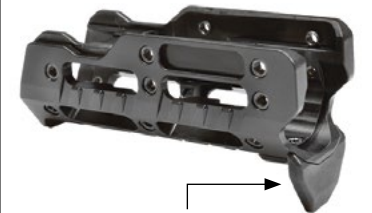

Optional hand stop (Part#: 5181-HS) (Also fits on #4197 & #6381)

SURVEILLANCE KIT

BUILD YOUR OWN

DESCRIPTION TABLE	
2700-KIT5	Surveillance Kit 2700 complete system (Part I/B/C/D/E/F/J)
2322-B	Surveillance Kit Extension
2322-C	Surveillance Kit Centre Rail
2322-D	Spacer for Inverter Kit
2322-E	Extra Side Rail for Inverter Kit
2322-F	3 rails Inverter Kit
2322-I	Surveillance Kit Front Section (2700 Model)
2322-J	Surveillance Kit Back Section (2700 Model)
2322-K	Adaptor for Rifle Scope
2322-P	Inverter Kit to Picatinny Adaptor
2322-Q	Kestrel Holder (see page 81) NEW

SPECIALTY ADAPTERS	
2322-H144	Adaptor Block for Canon Camera
2322-H145	Adaptor Block for Vector Laser Range Finder
2322-H146	Adaptor Block for 60x Swarovski Spotter Scope
2322-H147	Adaptor Block for 40x Leupold Spotter Scope Goldring
2322-H149	Adaptor Block for LRF Vectronix PLF25C
2322-H150	Adaptor Block for Coral-CR-C AN/PAS 503

INDIVIDUAL KIT

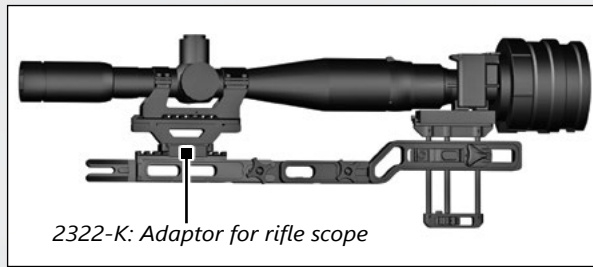

K ADAPTOR FOR RIFLE SCOPE



I SURVEILLANCE KIT FRONT SECTION

One quick adjust button for your night optic plus a precise micro adjustment wheel means you can achieve the perfect fit.

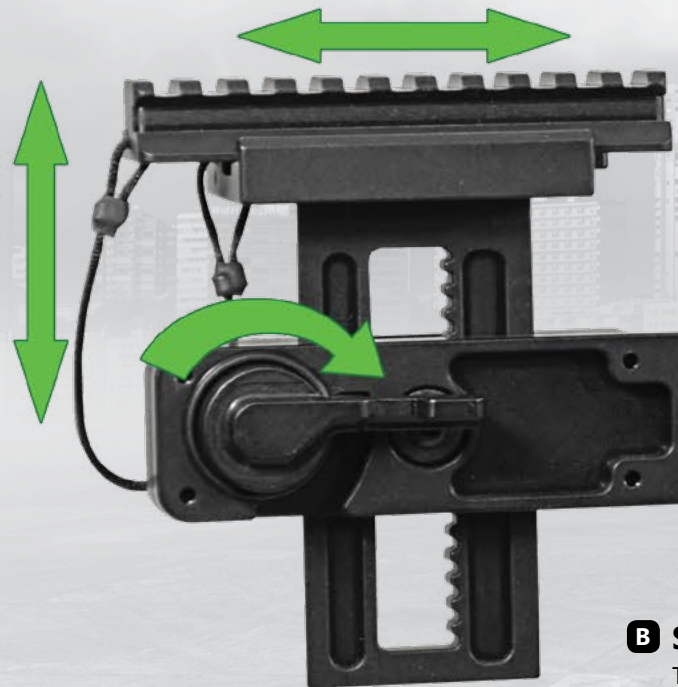

P INVERTER KIT TO PICATINNY ADAPTOR



F 3 RAILS INVERTER KIT

The Inverter Kit includes a unique spotting scope cradle that ensures the chassis and other mounted accessories are stable and aligned. It also allows the scope to float within the inverter as it is the scope's only point of attachment providing a secure connection between your spotting scope and the surveillance chassis. Can fit up to 5 rails.



E EXTRA SIDE RAIL FOR INVERTER KIT

Optional rail also available for mounted accessories.



D SPACER FOR INVERTER KIT



B SURVEILLANCE KIT EXTENSION

The extension is recommended for mounting night vision device at the front of the spotting scope.

C SURVEILLANCE KIT CENTRE RAIL

Multiple tripod mounts allow you to balance your gear on the tripod base and equally distribute the weight along the Surveillance Kit.



J SURVEILLANCE KIT BACK SECTION

The camera mount is equipped with a horizontal (left/right) adjustment for a precise fit. With the click of a button your camera's height is adjusted to match your spotting scope. If finer adjustment is needed, simply use the micro adjustment wheel and the perfect fit is achieved.

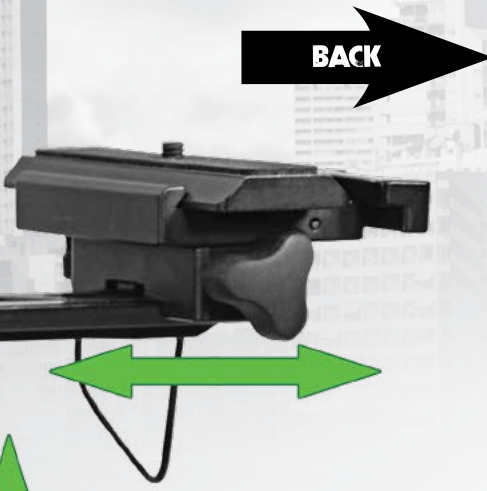

FRONT

BACK



SURVEILLANCE KIT

Cadex offers a wide variety of surveillance kits. Customers may request other mounting options to fill their particular requirements. Specially designed for the sniper or surveillance team, the Surveillance Kit decreases the amount of weight carried. The Surveillance Kit is easy to manipulate during extreme cold weather conditions and in darkness.

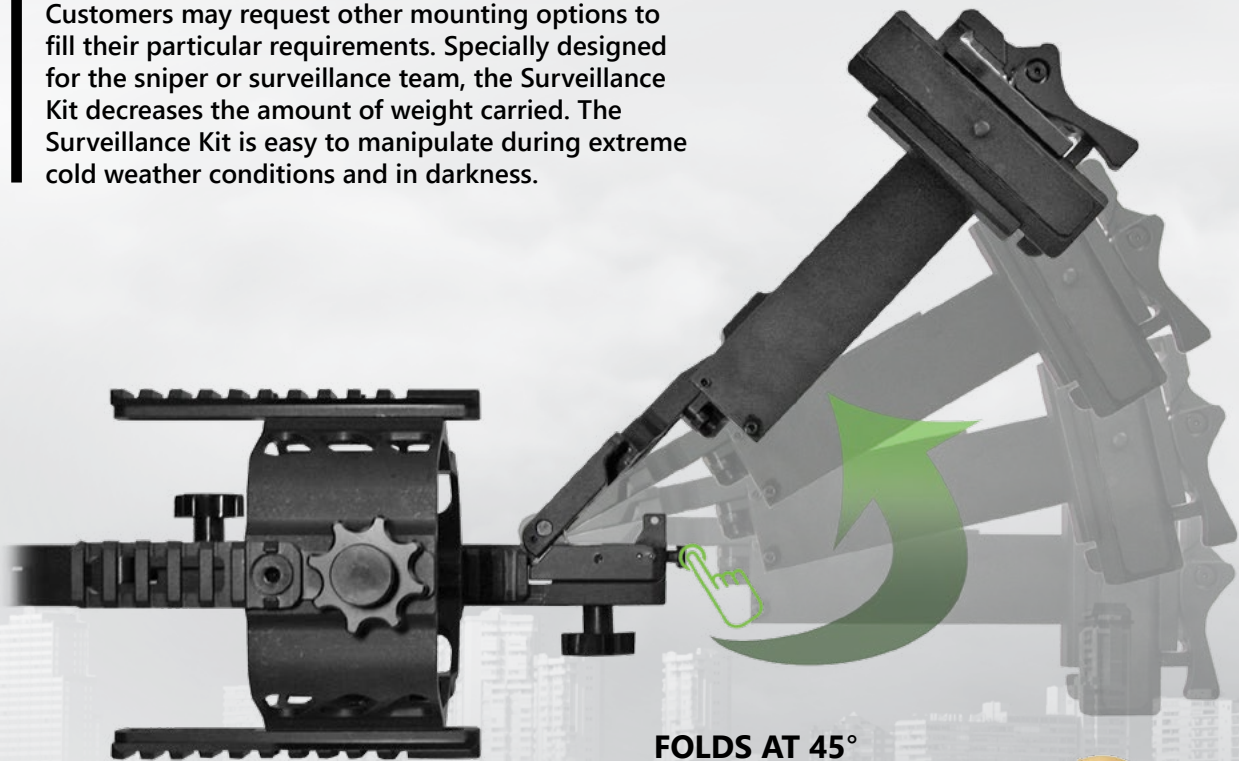

FOLDS AT 45°

The Cadex Surveillance Kit is convenient and easy to operate. Its adjustment system allows the operator to easily fine tune the component's placement. The Surveillance Kit's pivoting camera mount allows the operator to set up for photographic surveillance in a matter of seconds. Sighting scope inversion means your head is not the most visible point in your sighting system.

FEATURES:

- Easy to operate even with gloves.
- No tools required.
- Folds and dismantles for transportation.
- Designed for the Leupold Mark4 12-40X60 and 20-60X80 spotting scopes.

SPECIFICATIONS

Surveillance Kit

Part#: 2700-KIT5 (Complete System)

Dimensions:

30.19" x 4.91" x 11.42" | 76.67 x 12.48 x 29.01 cm

Weight: 4.54 lbs | 2061 grams

Material: Aluminum 6061-T6

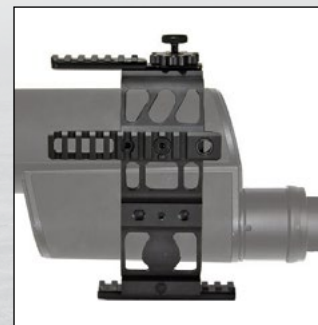

Kestrel Holder (Part#: 2322-Q)



PHOTONIS NIGHT VISION TUBES



How far can I see with my intensified Night Vision Device ?

This is the most commonly asked question by Night Vision Device (NVD) users. One of the most critical "parameters" for Night Vision Devices (NVD) is the Detection/ Recognition/ Identification (DRI) range at various light levels. The further distance the user can see, the faster he can react.

FEATURES:

- Multi-Mission Night Vision
- Extended bandwidth
- Autogating (ATG)
- Reduced Halo
- Excellent Life-Time

4G TECHNOLOGY



The 4G standard is the latest technology in intensified night vision. 4G is specifically designed to address the stringent requirements of special forces operators. Only 4G can offer ultra-fast Auto-Gating, the smallest halo and unrivalled spectral range from ultraviolet to near infrared. Gain the unfair advantage in the darkest nights, in all terrain and operations. Get the best DRI* range and be the first to see.

- Unsurpassed DRI ranges possible by Non ITAR 4G Image Intensifiers
- FOM min 2200 and higher
- Out of Band capability, seeing lasers beyond 1000nm
- Extremely suitable for Multi Mission
- Excellent life time
- Smallest Halo
- Ultra fast Auto-gating
- Unsurpassed High Light Level Resolution

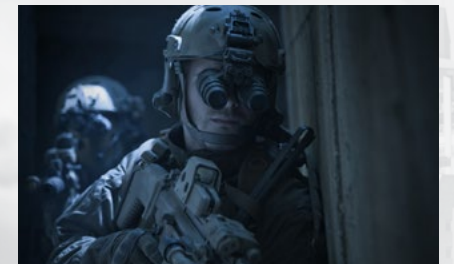

NOCTURN

Designed for crystal clear imagery in day-through-night lighting conditions, Photonis technology offers a wide variety of imaging products with high resolution, high frame rates and low light capabilities.

- Seeing in all conditions (Day / Night / Extreme night)
- Seeing far away (zoom capabilities)
- Staying stealth (seeing through windows)
- Recording / transmitting
- Providing beyond-the-eye information (Fusion, color at night, stealth lasers)
- Easy-to-integrate solutions based on video standards
- Ruggedized cores adapted to most demanding environments (MIL std, rifles...)



LOW PROFILE FLIP UP MOUNT

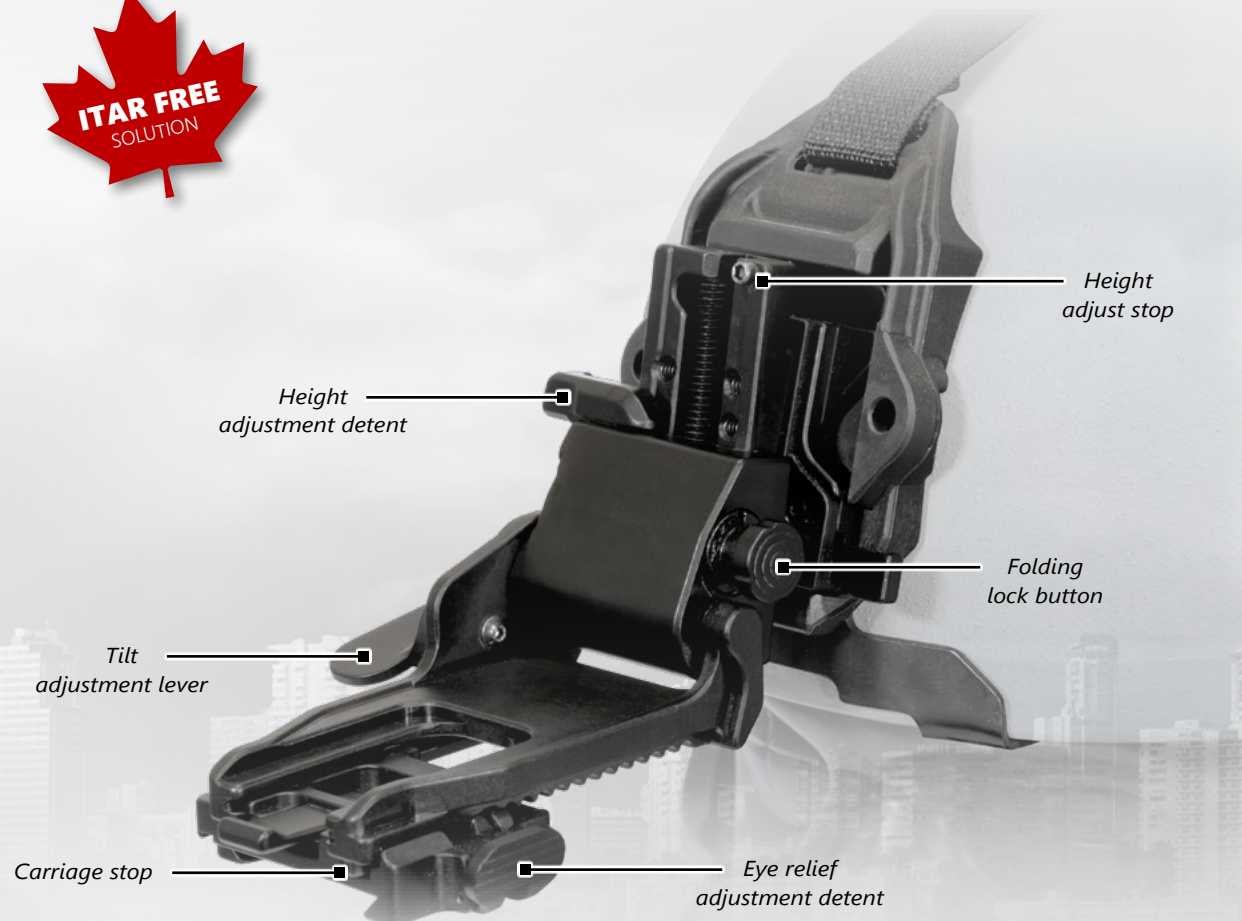

*Dovetail configuration shown

The Cadex Low Profile Flip Up Mount is a ruggedized aluminum NVG mount that combines lightness to low profile design with a maximum range of adjustability.

FEATURES:

- Ergonomic "one touch" height adjustment allows operator to adjust height with one hand.
- Low profile follows helmet contour when folded.
- Six position adjustable mounting plate fits numerous facial profiles and helmet mounting systems.
- The Low Profile Flip Up Mount will lock in the upright and down positions.
- If the NVG is bumped or impacted the Low Profile Flip Up Mount will fold and lock in upright position protecting the NVG and operator.

Low Profile Flip Up Mount

Part#: 643-5878FK (with Dovetail carriage)
Part#: 643-5878-A010 (with Bayonet/PVS carriage)

Dimensions:
2.89" x 4.58" x 2.87" | 7.34 x 11.63 x 7.29 cm

Dimensions folded:
2.89" x 2.04" x 3.45" | 7.32 x 5.18 x 8.76 cm

Weight: 0.4 lbs | 181 grams

Material: Aluminum 6061-T6



FLIP UP MOUNT



*Dovetail configuration shown

Ultra-lightweight and maintenance-free design made out of reinforced nylon to endure desert sand and salt water. Fits a wide variety of helmet designs and is compatible with dovetail or bayonet style NVG interfaces. Cadex offers multiple kits that will adapt to your specific needs.

FEATURES:

- Lightest Flip Up Mount offered by Cadex.
- Large adjust knobs provide easy adjustments with gloves on.
- Nylon construction allows for silent manipulation of flip up.
- Endures desert sand and salt water.

SPECIFICATIONS

Flip Up Mount

Part#: 643-93FK-206 (with Dovetail carriage)
Part#: 643-93FK-207 (with Bayonet/PVS carriage)

Dimensions:
3.48" x 4.23" x 4.71" | 8.85 x 10.76 x 11.97 cm

Weight: 0.33 lbs | 151 grams

Material: Nylon ST-801 Black / Aluminum 6061-T6

SPECIFICATIONS

MICH Shroud

Part#: 643-A214

Dimensions:
3.35" x 1.62" x 2.98" | 8.51 x 4.12 x 7.58 cm

Weight: 0.13 lbs | 60 grams

Material: Aluminum 6061-T6 / Stainless steel

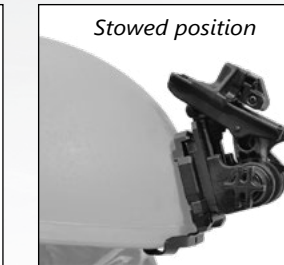
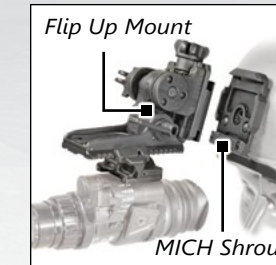

— FLIP UP MOUNT CONFIGURATIONS —

— UNIVERSAL HELMET STRAP KIT —

LOW PROFILE FLIP UP MOUNT (ALUMINUM)

Part#: 643-5878FK (Dovetail) Part#: 643-5878-A010 (PVS/Bayonet)

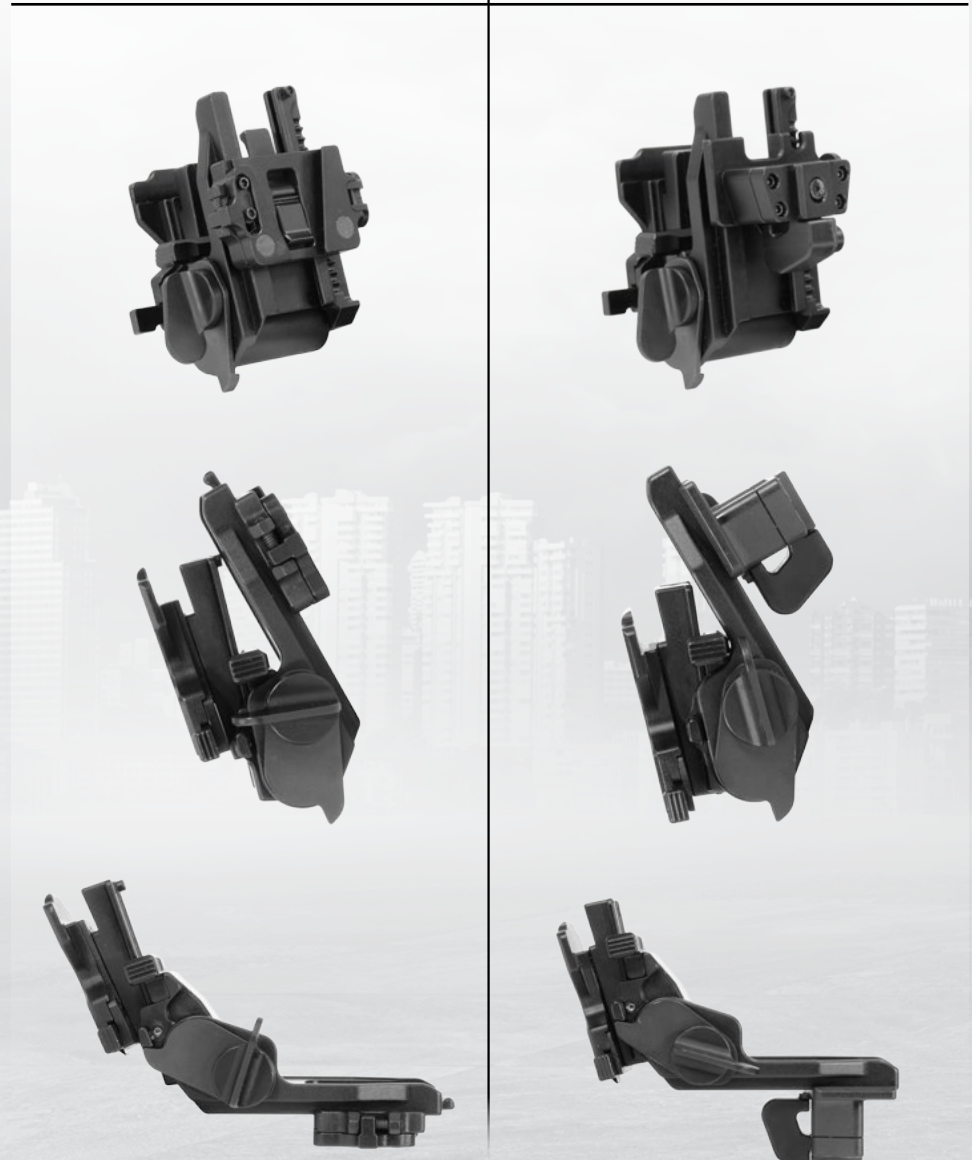

FLIP UP MOUNT (POLYMER)

Part#: 643-93FK-206 (Dovetail) Part#: 643-93FK-207 (PVS/Bayonet)

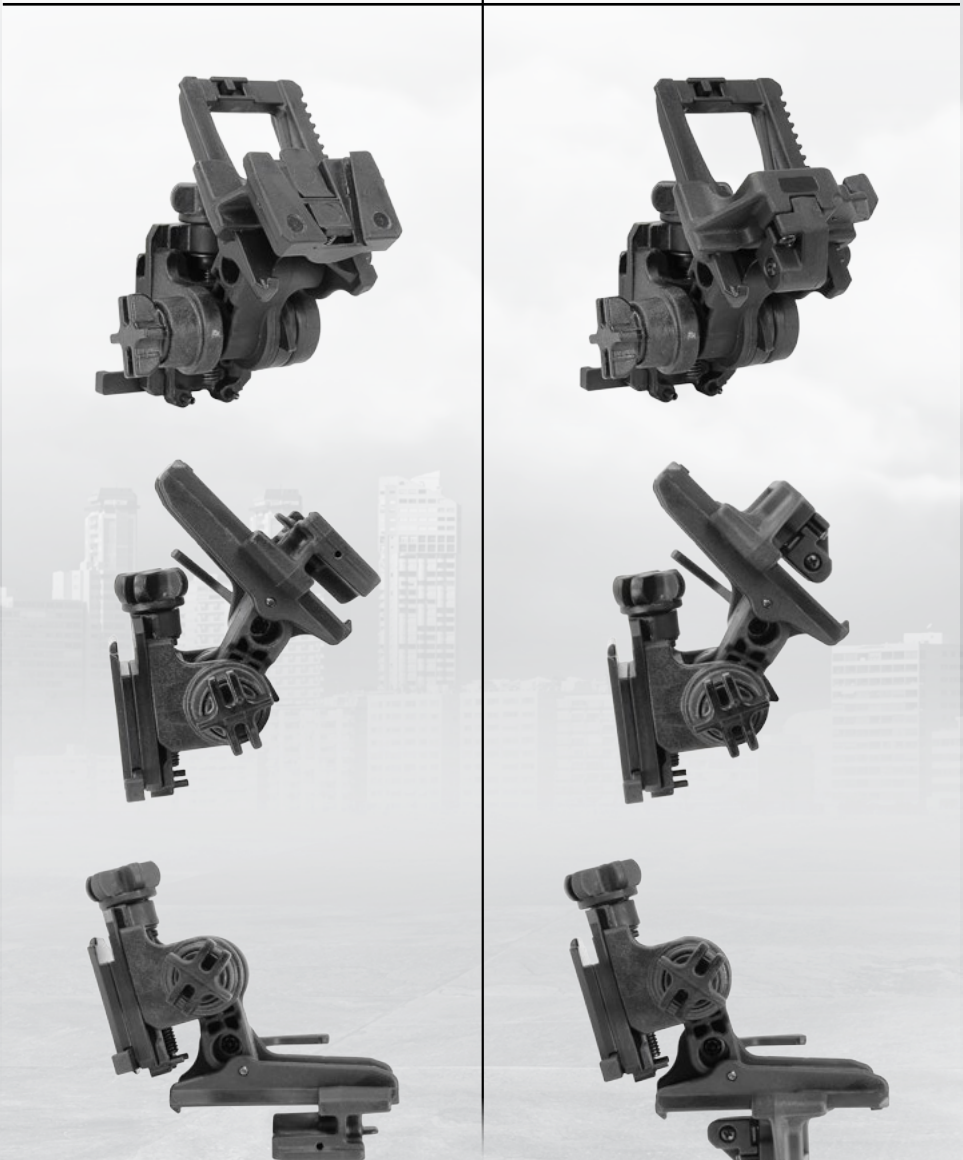

The Cadex NVG Helmet Mount provides operators with the ultimate precision mounting platform for night vision devices. NVG devices are held rigidly in the viewing position and when flipped up, are locked firmly into position. Rugged adjustment mechanism for easy one hand operation.

FEATURES:

- Personalized height and eye relief of night vision device.
- An easy-to-use screw mechanism gives the operator complete control of the tension of the flip-up mount.
- Provides mounts for both bayonet and dovetail type brackets.
- Optional counter-weight or battery pack bracket.
- Available for different helmet designs.
- Ultra lightweight.

SPECIFICATIONS

Universal Helmet Strap Kit
 Part#: 643-93SK-026 (for MICH Helmet)
 Part#: 643-93SK-027 (for PASGT Helmet)

Dimensions:
 15.14" x 4.5" x 7.72" | 38.47 x 11.44 x 19.61 cm

Weight: 0.4 lbs | 181 grams

Material: Nylon ST-801 Black

**Also available complete with adjustable straps for helmets without mounting holes.*



ACH Side-Mounted Helmet Bracket
 Part#: 1835-A010

- Mil Std M1913 style rail
- Fits ACH style helmets
- Left and right side assemblies



Side-Mounted Helmet Bracket
 Part#: 1835

- Mil Std M1913 style rail
- Fits numerous military helmets
- Can be fitted to any model of helmet upon request.

SOLO SIGHT MOUNT



The SOLO Sight Mount is the backbone of the US Marine Corp's HMGSS (Heavy Machine Gun Sight System). Named the BERM (Ballistic Extended Rail Mount), it has been assigned the M520 designation.

INTERFACES WITH:



The SOLO sight mount dramatically enhances the fighting capabilities of the soldier during day and night conditions. The system is the world's premier military off-the-shelf sight mounting solution. It is designed to enhance the sighting capabilities of NATO-standard weapons such as:

- The M2 .50 cal (12.7mm) Heavy Machine gun
- The 40mm MK19 Grenade Machine gun
- The 40mm Heckler & Koch Grenade Machine Gun

The SOLO platform integrates up to three sight modules in a wide variety of configurations, and provides both day and night sight capabilities.

The system allows for a rapid switch from active to passive target acquisition mode. During firing, the operator adjusts the range with one hand while the other is free to control the weapon. An illuminated range dial permits the operator to rapidly set the range for a quick engagement, day or night.

SPECIFICATIONS

SOLO Sight Mount Part#: 724-940

Dimensions: 17.27" x 7.18" x 8.61" | 43.88 x 18.26 x 21.89 cm

Weight: 9.3 lbs | 4220 grams

Material: Aluminum 6061-T6

SOLO SIGHT MOUNT

The SOLO mount incorporates a precise mechanical spin drift compensation for 40mm high velocity grenades. The SOLO also has a unique integral mount buffer system, which allows the operator to keep an eye on the sight and also protects the optical modules by absorbing 88% of harsh peak recoil forces.

FEATURES:

- Accommodates up to 4 day/night electro-optic devices.
- Increases lethality of both 40mm and .50 cal platforms.
- 40mm mechanical spin drift compensation.
- 88% absorption of peak recoil forces.
- Illuminated Range Dial.
- Customizable configurations.



The SOLO Sight Mount converts a zone-spreading machine gun into a precise target engagement tool with one round one hit capability at extreme ranges.



Optional rubberized eyepiece for Specter DR or Leupold CQBSS

KOLOS SIGHT MOUNT



The KOLOS Sight Mount converts a zone-spreading machine gun into a precise target engagement tool with one round one hit capability at extreme ranges.



Optional Quick Detach Bracket

The KOLOS Sight Mount significantly enhances day and night fighting capabilities of the .50 Caliber M2 Machine Gun, 40mm MK19. With the KOLOS mount, the gunner is able to rapidly transition from active to passive target acquisition methods to produce maximum effective fire on the target.

Because of the KOLOS mount buffer system, the gunner can keep his eye against the sight eye cup during firing to maintain the sight picture.

FEATURES:

- Low profile buffering of optics systems.
- Accommodates up to 4 day/night electro-optic devices.
- Increases lethality of .50 cal platforms.
- 88% absorption of peak recoil forces.
- Customizable configurations.

SPECIFICATIONS

KOLOS Sight Mount

Part#: 2607
Dimensions: 12.27" x 5.78" x 2.78" | 31.17 x 14.68 x 7.06 cm
Weight: 4.52 lbs | 2050 grams
Material: Aluminum 6061-T6

QUICK DETACH BRACKETS

SPECIFICATIONS

QD Bracket, Male Interface SOLO

Part#: 00573-A222
Dimensions: 6.9" x 1.69" x 2.41" | 17.52 x 4.29 x 6.12 cm
Weight: 0.71 lbs | 322 grams
Material: Aluminum 6061-T6



SPECIFICATIONS

QD Bracket, M2 Interface SOLO

Part#: 00573-A219
Dimensions: 7.54" x 3.7" x 1.6" | 19.15 x 9.4 x 4.06 cm
Weight: 0.73 lbs | 332 grams
Material: Aluminum 6061-T6



SPECIFICATIONS

QD Bracket, MK19 Interface SOLO

Part#: 00573-A221
Dimensions: 7.51" x 2.42" x 3.52" | 19.08 x 6.15 x 8.94 cm
Weight: 1.05 lbs | 476 grams
Material: Aluminum 6061-T6



SPECIFICATIONS

Fixed Bracket, MK19 Interface SOLO

Part#: 00573-A223
Dimensions: 7.38" x 1.58" x 3.03" | 18.75 x 4.01 x 7.7 cm
Weight: 1 lbs | 457 grams
Material: Aluminum 6061-T6



The Quick Detach Bracket is a mount interface for the SOLO and KOLOS which provides for "no tool" mounting on both the M2 12.7mm (.50cal) machine gun and the 40mm GMG (AGL).

FEATURES:

- Allows the user to remove and install the SOLO/KOLOS from their weapon with complete return to zero.
- Quick Detach Bracket installation does not require any modifications to the weapons.
- Does not interfere with normal function or handling drills.
- All versions of the SOLO already in service can be retrofitted with this mount.



SPECIFICATIONS

QD Bracket, 40mm Male/Female HK GMG (C16)

Part#: 00573-A011
Dimensions: 5.48" x 5.14" x 0.99" | 13.92 x 13.06 x 2.51 cm
Weight: 1.77 lbs | 803 grams
Material: Steel

RECOIL RAIL FAMILY

CM2 QUICK RELEASE BRACKET

The Cadex Recoil Rail provide electro-optic devices with protection from firing shock of hard recoiling weapons, such as the M2 .50 caliber machine gun.

The Cadex Recoil Rail uses a patented buffer system to absorb approximately 30% of the peak recoil forces which would otherwise be transferred to the mounted optic.

FEATURES:

- Absorbs approximately 30% of peak recoil forces.
- Returns the electro-optic to its original position after firing.
- Increases life expectancy of electro-optic devices.
- Can be used as bipod rail to improve follow up shots.
- Custom interfaces available for a variety of devices.
- Reduces the blur effect of iron sights when firing in full automatic mode.



Absorbs approximately 30% of Peak Recoil Force



***Warning:** Not recommended for optics or rifle scopes featuring a crosshair

SPECIFICATIONS

Recoil Rail Part#: RR-2337

Dimensions:
6.1" x 1.73" x 0.39" | 15.5 x 4.4 x 1.01 cm

Weight: 0.41 lbs | 187 grams

Material: Aluminum 6061-T6

SPECIFICATIONS

60mm BSMe Mortar Recoil Rail Part#: RR-2337-A007

Dimensions:
6" x 1.75" x 1" | 15.2 x 4.4 x 2.5 cm

Weight: 0.4 lbs | 184 grams

Material: Aluminum 6061-T6

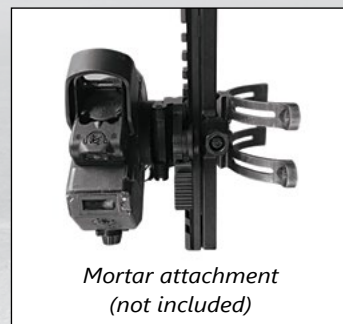

The Cadex CM2 Quick Release Bracket provides users with a solid optics mount for the M2 12.7mm (.50 cal) Heavy Machine Gun.

FEATURES:

- A 7.5" Mil Std M1913 Picatinny rail for secure optics mounting.
- Quick detach installation does not require any modification to the weapon.
- Made from a single piece of lightweight 6061-T6 aluminum.
- Tabs are made from a reinforced acetal to improve sliding and locking capabilities.
- Reinforced composite tabs also ensure that they are break-proof and will not wear out over time.
- A stainless steel screw secures the tabs to the Quick Release Bracket aluminum body.



SPECIFICATIONS

CM2 Quick Release Bracket Part#: 2905-A002

Dimensions:
9.06" x 4.13" x 3.94" | 23 x 10.5 x 10 cm

Weight: 1.6 lbs | 726 grams

Material: Aluminum 6061-T6

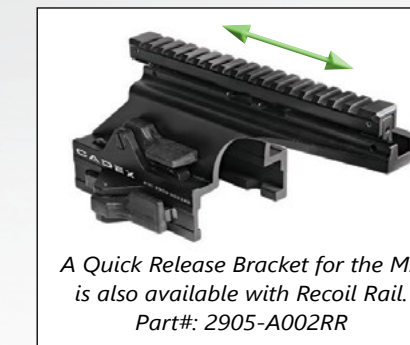

C9/M249 BUTTSTOCK ADAPTOR



The Cadex Buttstock Adaptor allows the fitting of issued and aftermarket M4/C8 carbine buttstocks to the C9/M249* light machine gun so that the user can tailor their length of pull and eye relief as required.

FEATURES:

- Mounts by using the existing take down pins.
- Accommodates a wide variety of M4/C8 carbine buttstocks.
- Allows organizations to use the same buttstock and sling plate components for their carbine and light machine gun fleets, simplifying spare parts and training requirements.

***Warning:** Fits only on C9/M249 models equipped with a hydraulic buffering system



SPECIFICATIONS

C9/M249 Buttstock Adaptor

Part#: 536

Dimensions:
2.3" x 2.06" x 3.65" | 5.84 x 5.25 x 9.29 cm

Weight: 0.32 lbs | 145 grams

Material: Aluminum 6061-T6

The Cadex Dual Rail for the C9, M249 and FN Minimi Light Machine Guns provides the user with a versatile, lightweight mount for laser pointers and illumination devices.

FEATURES:

- Mil Std M1913 rails at the 3 and 9 o'clock positions.
- Reduces heat and vibration transferred to attached electro-optics.
- Provides excellent zero retention of mounted devices.
- Clamps to the weapon receiver and indexes with the machine gun's front mount bushing.

SPECIFICATIONS

C9/M249 Dual Rail Part#: 578

Dimensions:
5.15" x 3.76" x 3.2" | 13.08 x 9.57 x 8.13 cm

Weight: 0.53 lbs | 241 grams

Material: Aluminum 6061-T6



DUAL RAIL



The Cadex Tri-Rail for the C9, M249 and FN Minimi LMGs provides the gunner a solid mount for lights, aiming lasers, and other weapon accessories.

FEATURES:

- Minimizes heat transfer to the gunner's hand when firing at high rate of fire.
- Provides three Mil Std M1913 rails, at 3, 6 and 9 o'clock.
- The side rail location is optimized to place aiming lasers in the same horizontal plane as the barrel axis.
- Keeps accessories mounted close to the weapon's center of gravity.

SPECIFICATIONS

C9/M249 Tri-Rail Part#: 1212

Dimensions:
10.98" x 2.66" x 3.89" | 27.9 x 6.78 x 9.89 cm

Weight: 1.06 lbs | 482 grams

Material: Aluminum 6061-T6

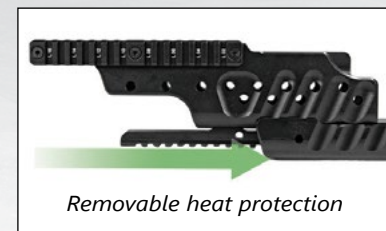

C9/M249 TRI-RAIL



C6 BUTTSTOCK



The Cadex C6 Buttstock provides the operator with a world-class fully adjustable precision buttstock. Designed in such way as to enhance shooting comfort, resulting in field precision. Easily adjustable for the length of pull. This new C6 Buttstock is entirely compatible with the existing C6 Buttstock which makes it simple to retrofit the existing one. Ergonomic design for easy maneuverability and precision improvement, it extends (2 inch travel) / collapses without any tools.

FEATURES:

- Easy to retrofit existing C6.
- Extends (2 inch travel) /collapses without any tools.
- Ergonomic design for easy maneuverability.
- Made of aluminum 6061-T6 with some components made of fiber reinforced composite.
- Ambidextrous.
- Up/down cheek piece adjustment.
- Forward/rearward cheek piece adjustment.



SPECIFICATIONS

C6 Buttstock Part#: 4016

Dimensions:
8.66" x 2.08" x 5.56" | 22 x 5.28 x 14.12 cm

Dimensions extended:
10.66" x 2.08" x 7.76" | 27.08 x 5.28 x 19.71 cm

Weight approx.: 2.2 lbs | 998 grams

Material: Aluminum 6061-T6

C6/M240 DUAL RAIL

The Cadex Dual Rail for the C6, M240, and MAG 58 Machine Guns provides users with a robust mount for laser pointers and illumination devices.

FEATURES:

- Mil Std M1913 rails at the 3 and 9 o'clock positions. Optional positioning at 6 o'clock and 45° angle.
- Reduces heat and vibration transferred to attached electro-optics.
- Provides excellent zero retention of mounted devices.
- Configurable rails.
- Optional 6 o'clock rail positioning for mounting a folding grip.

SPECIFICATIONS

C6/M240 Dual Rail Part#: 1166-2

Dimensions:
6.14" x 3.52" x 1.89" | 15.5 x 8.95 x 4.81 cm

Weight: 0.63 lbs | 285 grams

Material: Aluminum 6061-T6

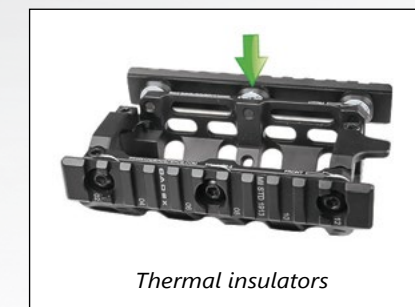
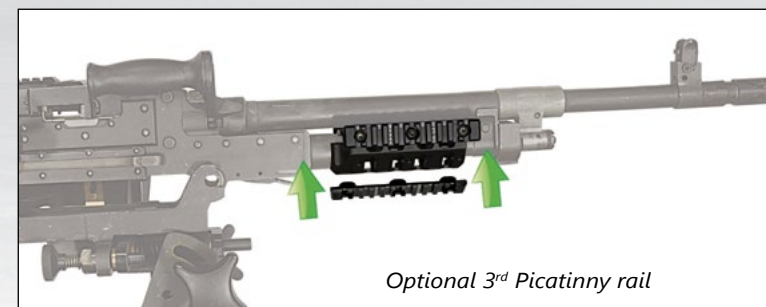

M2 CRADLE MOUNT

SPECIFICATIONS

M2 Cradle Mount Part#: 6987-A100

Dimensions:

20" x 13.75" x 15" | 50.8 x 34.93 x 38.1 cm

Weight: 50.1 lbs | 22 725 grams

Material: Steel / Cerakote paint

Optional
SOLO Sight Mount

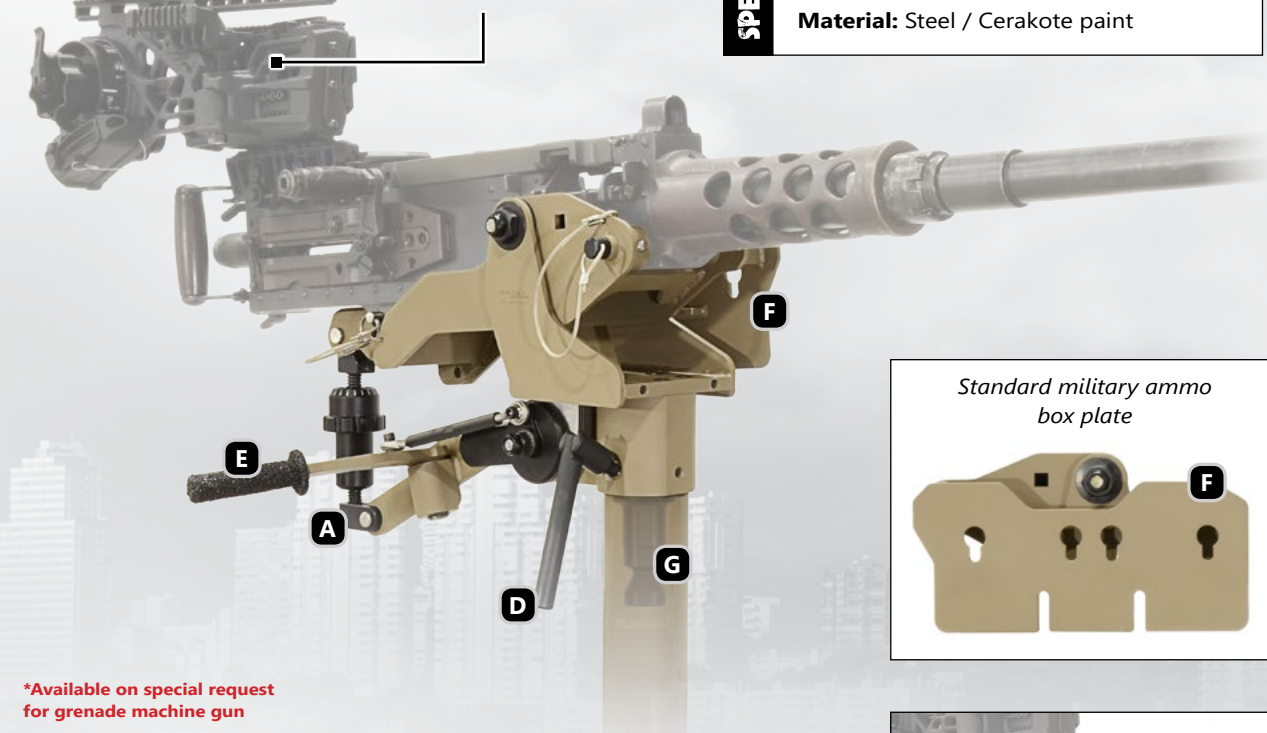

Standard military ammo
box plate



The Cadex M2 Cradle Mount has been developed to provide an easy to operate affordable mounting solution for the Browning M2.

- A- Micro adjustable elevation system with 1 mil increment per click.
- B- 2-point balanced mounting system. SOLO Optic enhancement package ready
- C- Blackened stainless steel Machine Gun mounting pins.
- D- User-friendly threaded traverse locking mechanism.
- E- Responsive clutch locking elevation mechanism.
- F- Standard military ammo box plate.
- G- Standard M2 pintle adapter.
- H- Mark 93 Adapter Kit - M240/M249.
- I- M249 ammo box adaptor plate.

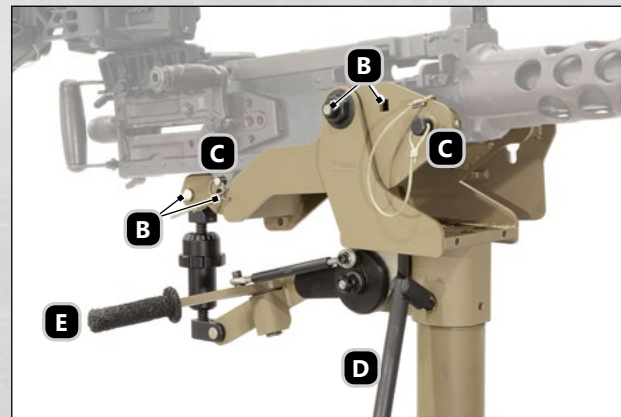

Mark 93 Adapter Kit - M240/M249

H-Part#: 06987-A016

I-Part#: 06987-A015

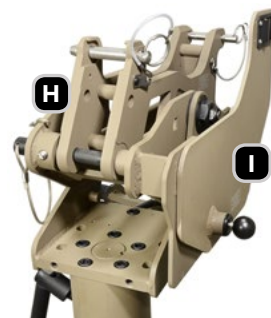

*Available on special request
for grenade machine gun

MAXIMUM ELEVATION RANGE

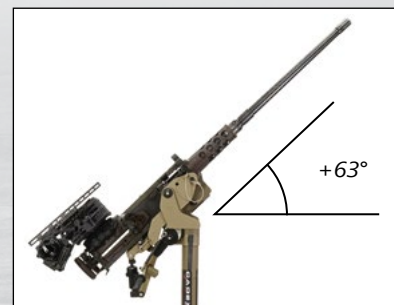
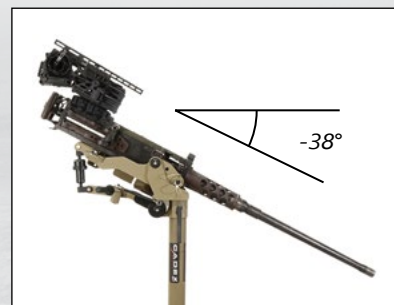

MG VEHICLE ARM

NOT AVAILABLE IN
NORTH AMERICA

SPECIFICATIONS

MG Vehicle Arm

Part#: 05573-A112

Dimensions:

15.47" x 5.68" x 8.73" | 39.29 x 14.43 x 22.17 cm

Weight: 13.1 lbs | 5940 grams

Material: Manganese Phosphate Steel / Aluminum 6061-T6

SPECIFICATIONS

Multi-Position MG Support

Part#: 05573-A111

Dimensions:

4.94" x 3.8" x 38.57" | 12.55 x 9.65 x 97.97 cm

Weight: 6.78 lbs | 3075 grams

Material: Manganese Phosphate Steel

The Cadex MG Vehicle Arm attaches to the multi-position MG support using its ACMAT pintle. It allows the mounting of a machine gun at two different locations, either at the end of the arm or at its center section using the NATO pintle. A fast release button is used to lock/unlock the MG pintle instead of the traditional push pin. Two tension adjustment knobs are used to restrain free movement of the machine gun depending on its weight.

The MG Vehicle Arm is a low profile system that can deploy in a couple of seconds for fast target engagement and can fold rapidly for transport. This is the ultimate MG mount and no other arm offers as much adjustability.



NATO Pintle receiver

ACMAT Pintle

MG mounting locations

Lock/Unlock button

Tension adjustment knobs

Cadex Multi-position MG support allows the mounting of the machine gun vehicle arm to be adjusted rapidly to fit operator's ergonomics. Internal piston controls the rising speed of the machine gun. Allows 12" of adjustment with 1" increments. Features a locking knob and a tension lever.

Multiple vehicle brackets can be offered to fit different vehicle models.

C16 COVER LATCH & HANDLE



Extended Cocking Handle
(Compatible with HK GMG only)



C16 Cover Latch



SPECIFICATIONS

C16 Cover Latch
Part#: 05119-A001

Dimensions:
10.66" x 3.57" x 3.26" | 27.08 x 9.07 x 8.28 cm

Weight: 1.86 lbs | 844 grams

Material: Aluminum / Stainless / Delrin



SPECIFICATIONS

Extended Cocking Handle
Part#: 05119-A050

Dimensions:
5.23" x 4.6" x 1.44" | 13.28 x 11.68 x 3.66 cm

Weight: 0.69 lbs | 313 grams

Material: Aluminum / Stainless / Delrin

Cadex Cover Latch assembly was designed for mission success. Built from 6061-T6 Aluminum, Delrin and Stainless steel.

FEATURES:

- Cover Latch assembly is easily indexed during complex operations both day and night.
- Single handed manual operation.
- Operator friendly for gun drills loading/unloading.
- Installs in minutes on the existing cover. No modifications required.

M2 FIRE

Cadex's M2 Front Interface Rail Equipment (M2 FIRE) rail system increases the target acquisition and engagement capabilities of the .50 caliber M2 Heavy Barrel machine gun.

FEATURES:

- Clamps to the barrel support of the M2HB weapon.
- Provides three Picatinny rails, at 3, 6, and 9 o'clock.
- Provides a solid mount for heavy weapon spotlights and aiming/illumination lasers.
- Does not affect normal function of the weapon, including barrel changes.
- Machined channels protect device cables.

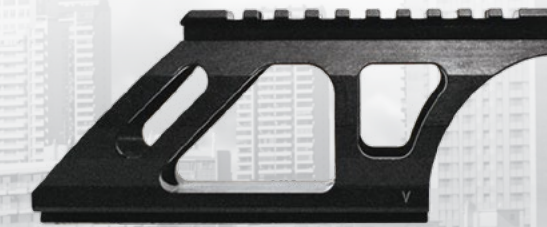

Optional Top Rail Part#: 1626-A002

- The optional top rail assembly provides a mounting surface for reflex sights.
- Does not interfere with weapon's iron sights.

SPECIFICATIONS

M2 Fire Part#: 1626-A001

Dimensions:
22.74" x 4.35" x 7.08" | 57.78 x 11.04 x 17.98 cm

Weight: 5.47 lbs | 2480 grams

Material: Aluminum 6061-T6

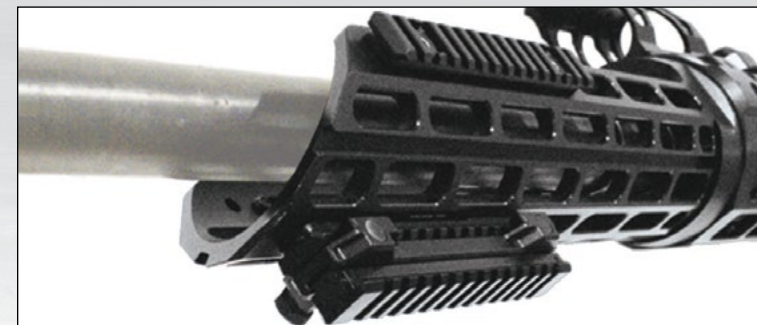

MOUNTABLE ACCESSORIES:

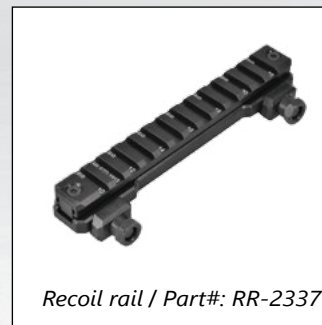

Recoil rail / Part#: RR-2337



Reflex sight



Flood light

37MM LAUNCHING CUP



Cadex 37mm Launching Cup is ideal for less lethal and crowd control situations. The Launching Cup is used in conjunction with a 37mm ballistic cartridge. The Cadex Launching Cup has a unique venting system which enables the operator to launch a hand deployed chemical grenade at graduated distances of 40, 60 and 100 m.

FEATURES:

- Allows for delivery of payload to extended ranges.
- May be used for denying access, cordons and channeling ops.
- A valuable tool to create distance and opportunity.

SPECIFICATIONS

37mm Launching Cup Part#: 4340

Dimensions:

2.61" x 1.42" | 6.63 x 3.6 cm

Weight: 1.44 lbs | 652 grams

Material: Aluminum 6061-T6

*Required thread pitch drawing available on request



BREACHING MULTI-TOOLS

The Cadex Telescopic Tactical Breaching Multi-Tool is one of the most powerful breaching tools available. A combination of breaching hammer, halligan tool, hinge breaker, and expedient ram. The Cadex Tactical Breaching Multi-Tool provides superior capabilities over traditional single use tools. Recently upgraded after ten years of service, the improved TBH allows the user to adapt their equipment to the mission at hand.

FEATURES:

- Its unique design incorporates the functionality of multiple tools, in a simple package. Carry one or carry five?
- Its telescopic design makes it very compact to carry. It can be used collapsed or extended.
- Can be interchanged between the hinge breaker or the optional "brake and rake tip".
- CQB Tactical Breaching Multi-Tool also available for use in restricted confines or as a secondary team tool.
- Replacement parts available on request:
 - Hammer head: #580-048
 - Hammer fork: #580-026

SPECIFICATIONS

CQB Part#: 580-A009

Dimensions:

9" x 2.5" x 16.24" | 22.86 x 6.35 x 41.27 cm **Extended:** 22.24" | 56.51 cm

Weight: 12.14 lbs | 5507 grams

TBH Part#: 580-A005

Dimensions:

9" x 2.5" x 23" | 22.86 x 6.35 x 58.42 cm **Extended:** 33.12" | 84.13 cm

Weight: 16.83 lbs | 7636 grams

Material: Aluminum 7075 (Tube) AISI 1045 Hardened Steel (Head and Fork)

CQB



Extended CQB

TBH



Extended TBH

*Contact Cadex prior to purchase for more information on recommended use

Optional "Brake & Rake" Tip (Part#: 580-A001)



Sling and sling mount included



CLIMBING HOOKS 4" & 7"



Long Assault Climbing Hook 7"

Short Assault Climbing Hook 4"

The Cadex Short (4") and Long (7") Assault Climbing Hook (SACH) provides the entry teams with an extremely versatile tool for vertical methods of entry in scenarios where it is not practical to use the larger Cadex extra Long Assault Climbing Hook.

FEATURES:

- Designed for use with an extension pole system to securely fix assault ladders in place on the wide variety of surfaces encountered during operations.
- Can be hand-emplaced.
- Carbide spikes ensure proper hook grip.
- Folds for easy transport and storage.

SPECIFICATIONS

Short Climbing Hook 4"

Part#: SH-1234

Dimensions:

1.97" x 2.35" x 4.67" | 5.02 x 5.97 x 11.87 cm

Static hook capacity: 1300 lbs | 589 670 grams

Weight: 0.78 lbs | 355 grams

Material: Aeronautical Aluminum (Frame) Carbide (Spike)

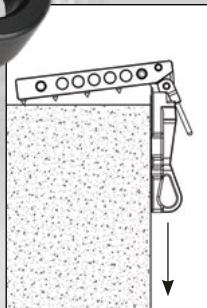

SPECIFICATIONS

Long Climbing Hook 7"

Part#: LH-1234

Dimensions:

2.03" x 2.35" x 6.9" | 5.16 x 5.97 x 17.53 cm

Static hook capacity: 1300 lbs | 589 670 grams

Weight: 1.1 lbs | 497 grams

Material: Aeronautical Aluminum (Frame) Carbide (Spike)

CLIMBING HOOK 14"

The Cadex Extra Long Assault Climbing Hook provides the entry teams with a versatile tool for use with pole systems to securely position assault ladders on irregularly shaped or rounded surfaces. It opens to multiple angles to provide three surfaces, allowing the hook to grab the face, top, and rear of differently shaped surfaces.

FEATURES:

- Designed for use with an existing pole system to securely fix assault ladders in place on the wide variety of surfaces encountered during operations.
- Can be employed with or without carabiners.
- Can be hand emplaced.
- The replaceable stainless steel spikes are extremely resistant to wear or breakage.
- Folds for easy transport and storage.
- Ideal for mud walls.

SPECIFICATIONS

Extra Long Climbing Hook 14"

Part#: DH-1867

Dimensions:

3.45" x 3.35" x 10.74" | 8.76 x 8.51 x 27.28 cm

Static hook capacity: 1000 lbs | 453 592 grams

Weight: 2.43 lbs | 1100 grams

Material: Aluminum 7075-T6 (Frame) Stainless Steel (Spike)



Each hook comes with 3 sets of hardened spikes in the following lengths:

1/2"
(12.7 mm)

3/4"
(19.1 mm)

1 1/2"
(38.1 mm)

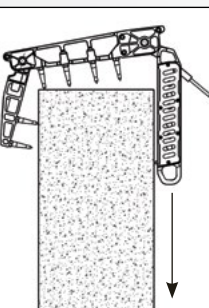

POLE LADDER

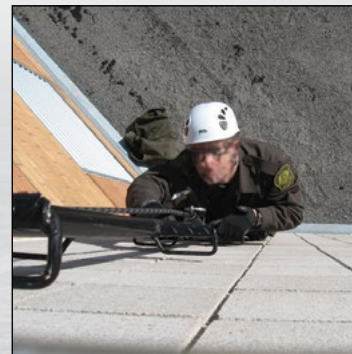
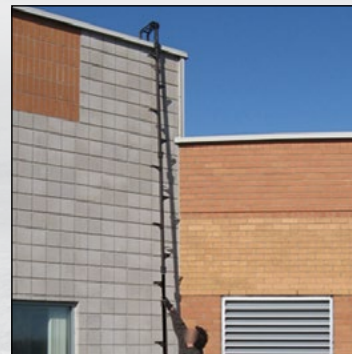
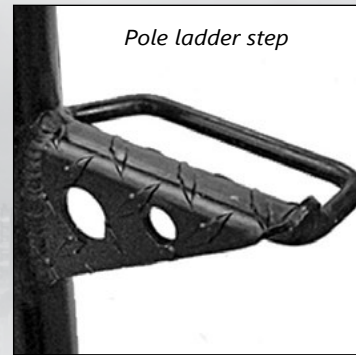

The Cadex Pole Ladder provides a secure rigid method of entry. A standard kit includes one hook, four pole sections and two half pole sections for over 25 feet of portable climbing power.

Custom kits can easily be built to suit the needs of the mission.

The kit's transport bag holds all five sections as well as the hook (transport bag is optional).

The Cadex Pole Ladder System is a modular ladder designed to provide assault personnel with a tool for rapid vessel entry and ability to scale most obstacles or buildings.

The hook is a strong, lightweight assembly easily folded by pressing the releases on each side of the hook.

Featuring stainless steel spikes and 8" of clearance the hook will attach securely to most surfaces. Different spike lengths are available.

The pole sections and hook assemble quickly, making this ladder extremely portable and compact for transport to the mission.

FEATURES:

- Modular design allows for custom kits suited to the needs of the mission.
- Pole tensile static load capacity is 2500 lbs.
- Hook has 8 inches of clearance.
- Large anti-slip step with good finger clearance.

POLE LADDER



Multiple spike lengths available

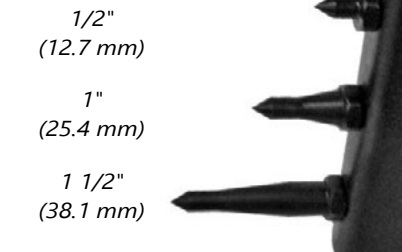

Pole Ladder transport bag



Non-Skid Delrin leg cover



Pole Ladder

Dimensions (Hook - Extended):

12" x 6.1" x 15" | 30.5 x 15.5 x 38.1 cm

Weight (Hook):

6 lbs | 2721 grams

Dimensions (Pole section):

12.3" x 3.2" x 64.45" | 31.24 x 8.13 x 163.7 cm

Dimensions (Half Pole section):

12.3" x 3.2" x 33.95" | 31.24 x 8.13 x 86.23 cm

Weight (Pole):

7 lbs | 3175 grams

Material (Hook & Pole):

Aeronautical Aluminum

Material (Spikes):

Stainless Steel

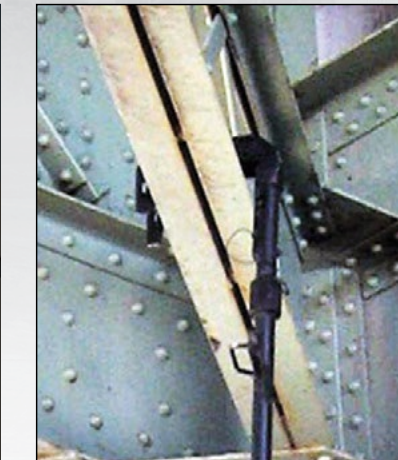

LADDER REEL



The Cadex Ladder Reel gives the user the capability to rapidly deploy their cable-type assault ladder. Its small size permits the ladder to be stowed in a compact package for transport to the entry site, and also provides the user with a quick recovery system for their ladders.

FEATURES:

- Provides the user tangle-free ladder deployment.
- Prevents cable ladders from becoming kinked, helping extend ladder life.
- Knurling on the handles provides a non-slip holding surface for positive control when in use.
- Holds up to 15 meters of cable type ladders, such as the Yates Special Ops Ladder.

SPECIFICATIONS

Ladder Reel Part#: LR-995

Dimensions:
18.75" x 11.75" | 47.62 x 29.84 cm

Weight: 8.6 lbs | 3900 grams

Material:
Aluminum 6061-T6 / Black Acetal Composite

PROMOTIONAL MATERIAL

SHOW STAND

- Modular design allows for custom kits suited to the needs of the dealer.
- Can fit up to five brackets, shelvings or chassis.
- Designed to work with complete rifles.



T-SHIRT / PATCHES / STICKERS



Buy online at
cadexdefence.com/store

CADEX CAP

- Black cap with embroidered "Cadex Defence" logo on the front and "Extreme Range Supremacy" on the back.



*Picture may differ from actual product

CADEX ARMOR X



CADEX Armor, a division of CADEX Inc., is a leading international specialist in the development, design and supply of defensive and inconspicuous armored security vehicles.

These special armored vehicles provide full "peace of mind" mobile protection for government officials, law enforcement personnel, security agencies, as well as private organizations and VIPs concerned about the violent threats of today's hostile urban environment.

Extreme care has been taken in the design and build of each of our armored vehicles to ensure that there is a perfect balance of complete ballistic and blast protection while maintaining a superior on/off road performance.

The Management team of CADEX Armor, consists of industry experts with decades of experience in the automotive and armoring industry. Our understanding of client safety needs and knowledge of new ballistic materials have helped us bring to market what we believe is a truly better and stronger built Armored Security Vehicle.

Mr. Kemal Gursoy
CADEX ARMOR Project Specialist

kemal@cadexinc.com

VISIT CADEXARMOR.COM FOR MORE INFORMATION



CEN B6+

MERCEDES BENZ SPRINTER 3500 HD VIP



TV, DVD, MICROWAVE, COFFEE MACHINE



VIP 7 PASSENGER CONFIGURATION:
HEATED, VENTILATED, MASSAGE SEATS,
EXTRA REAR INDEPENDENT A/C UNIT.



SPRINTER 3500 HEAVY DUTY CHASSIS
3.0 V6 DIESEL AUTOMATIC TRANSMISSION - EXTRA LONG WHEELBASE, HIGH ROOF

HTA-1

ARMORED PERSONNEL CARRIER



PREMIUM ARMOR SPECIFICATION CEN B6+ | CEN B7 | NIJ III | NIJ IV UP TO .50 CALIBER



CADEX R&D SOLUTIONS

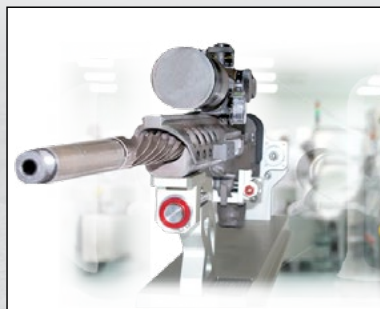
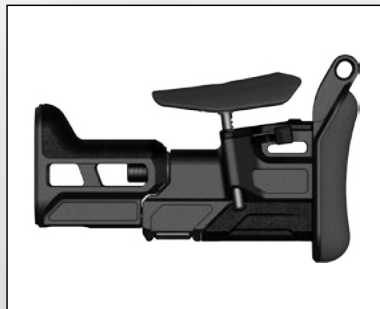
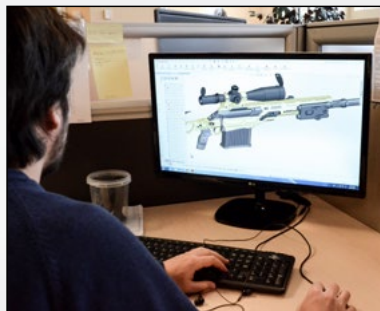

+ EXPERTISE

Cadex has worked with both conventional military and Special Forces, successfully delivering our products to a broad range of customers worldwide. Cadex works with its customers in a team approach to identify the mission requirements in order to meet their specific needs.

+ INNOVATION

Cadex's design and manufacturing team ensures the customer has access to leading edge technology.

+ DESIGN

When creating the design, Cadex's R&D department works seamlessly with the production department to ensure the manufactured item meets the customer's requirements no matter the complexity.

+ SOLUTION

Cadex's R&D department's initial design is quickly turned into a prototype for customer evaluation. Cadex can use its 3D printing, molding, and machining capabilities to produce a broad range of prototypes.

+ MANUFACTURE

Cadex can call upon its in-house capabilities to produce a broad range of products. This includes weapon components, tactical breaching equipment, gun stocks, recoil management systems, and precision mounts for electro-optic systems.

+ DELIVERY

Cadex provides the edge needed when you need it most. Our equipment is in service worldwide.

+ SUPPORT

With Cadex every product comes complete with knowledgeable customer support. Our quick and efficient staff is known worldwide for its legendary quality of service as well as its uncompromising discretion.

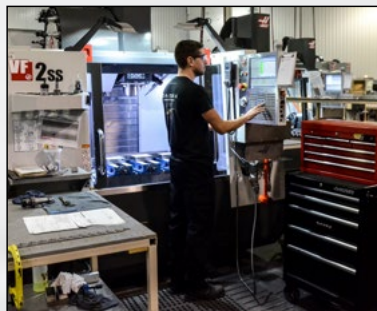

Shotgun Testing Bench Project



Serge Dextraze
President/CEO

Message from the president

"For over 20 years, Cadex has designed and manufactured an extensive line of high quality and premium products for Special Operations, Military, Law Enforcement and Civilians across the globe. In each field of operation, we bring to you a team of specialized and dedicated professionals. Ready to guide you forward and best supporting your multiple mission requirements. We would like to thank our long standing customer base for their ongoing trust and support."



Patrice Picard
Canadian & International
Senior Sales Manager
Canada Office: 450-348-6774
Cell: 514-821-7983
patrice@cadexinc.com



Darryl Miller
USA
Military, Law Enforcement
& Commercial Sales
USA Office: Swanton
Cell: 770-713-6354
darryl@cadexinc.com



Tom Larder
USA
Commercial Sales Representative
Cell: 925-456-HUNT (4868)
tlarder@cadexinc.com



Jim Peter Safar
International
Business Development Director
Canada Office: 450-348-6774
Cell: 514-998-9439
jimpeter@cadexinc.com



Scott McLeod
Canadian & International
Military, Law Enforcement
Project Specialist
Canada Office: 450-348-6774
scott@cadexinc.com



Phil Gravel
Canada Office
Customer Service Representative
Canada Office: 450-348-6774
pgravel@cadexinc.com

CUSTOMER'S PICTURES

Do not hesitate to send us pictures of your builds at: marketing@cadexinc.com so that we can showcase them on our website and social media! And thanks a lot to those who already did!



If you appreciate Cadex products, please take a minute to let us know at customerservice@cadexinc.com

Follow us!





WWW.CADEXDEFENCE.COM

CADEX DEFENCE

755 ave. Montrichard,
Saint-Jean-sur-Richelieu, QC Canada, J2X 5K8
Tel: 450-348-6774 Fax: 450-348-7157
Toll free: 1 888 348-6774

CADEX DEFENSE CORP

107 Robin Hood Dr, Swanton
VT 05488, USA
Tel: 802-466-4003 Fax: 450-348-7157
Toll free: 1 888 348-6774

EXTREME RANGE SUPREMACY