

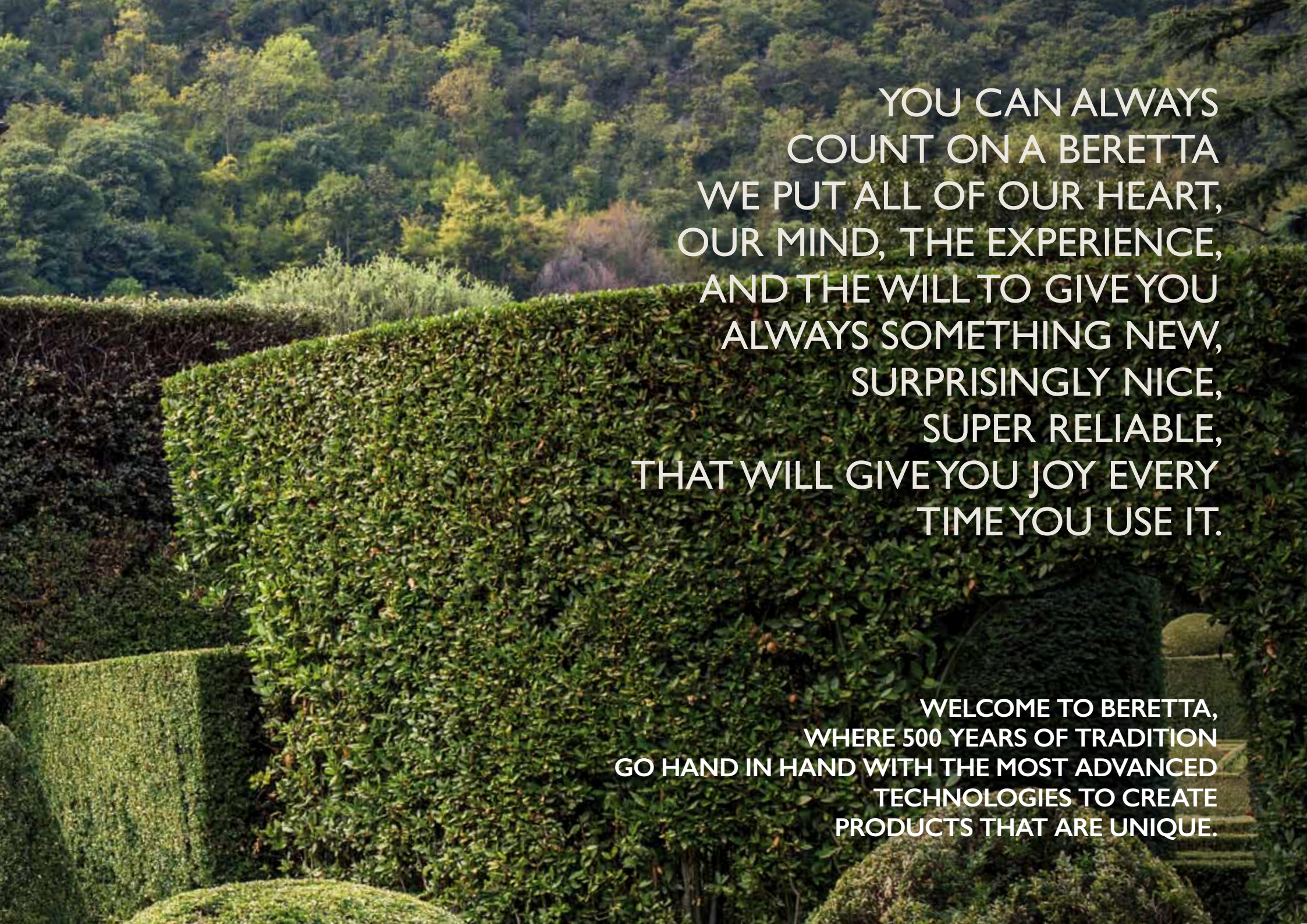

 BERETTA

2018 FIREARMS CATALOG





**YOU CAN ALWAYS
COUNT ON A BERETTA
WE PUT ALL OF OUR HEART,
OUR MIND, THE EXPERIENCE,
AND THE WILL TO GIVE YOU
ALWAYS SOMETHING NEW,
SURPRISINGLY NICE,
SUPER RELIABLE,
THAT WILL GIVE YOU JOY EVERY
TIME YOU USE IT.**

**WELCOME TO BERETTA,
WHERE 500 YEARS OF TRADITION
GO HAND IN HAND WITH THE MOST ADVANCED
TECHNOLOGIES TO CREATE
PRODUCTS THAT ARE UNIQUE.**



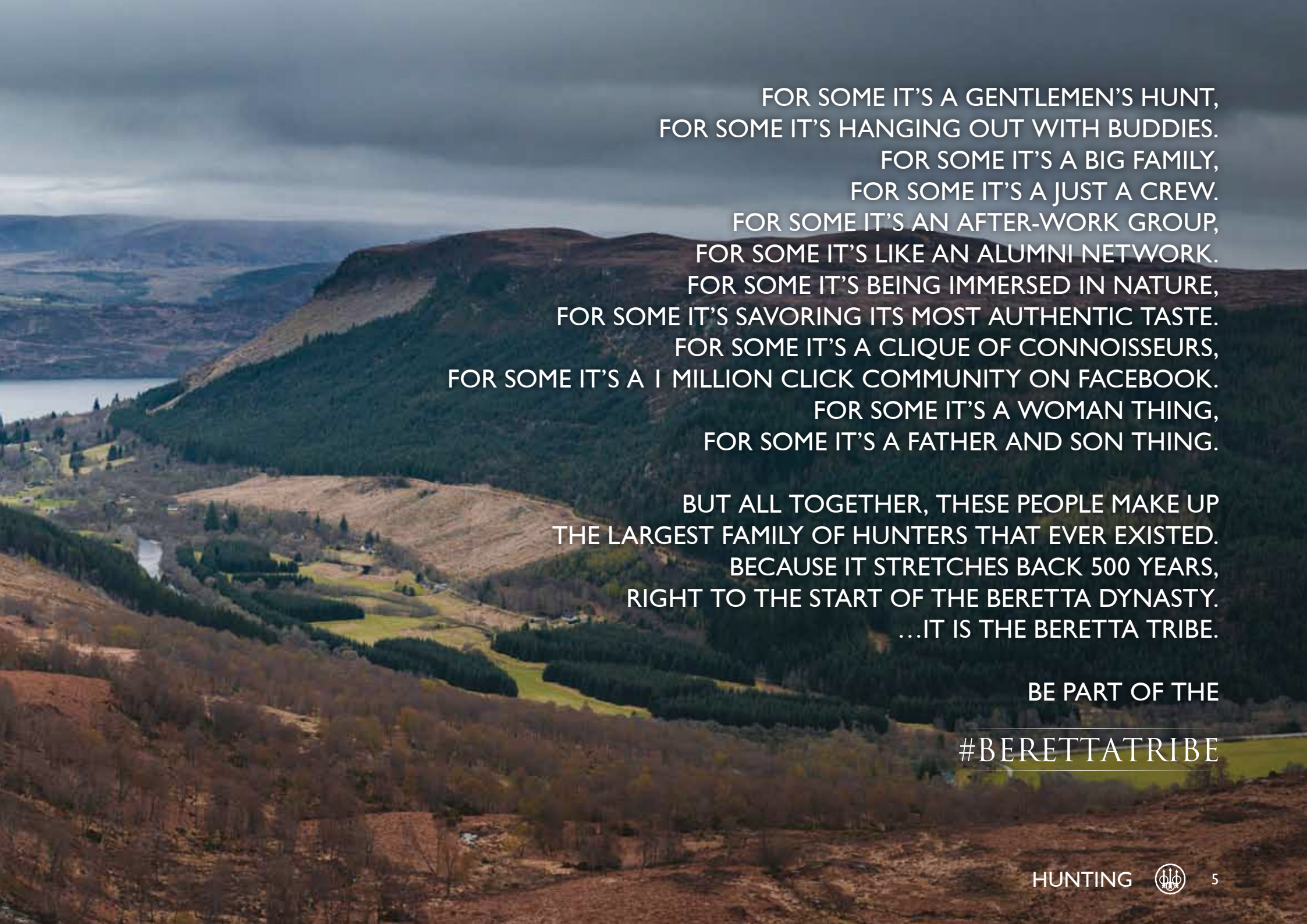

FOR SOME IT'S A GENTLEMEN'S HUNT,
FOR SOME IT'S HANGING OUT WITH BUDDIES.
FOR SOME IT'S A BIG FAMILY,
FOR SOME IT'S A JUST A CREW.
FOR SOME IT'S AN AFTER-WORK GROUP,
FOR SOME IT'S LIKE AN ALUMNI NETWORK.
FOR SOME IT'S BEING IMMERSED IN NATURE,
FOR SOME IT'S SAVORING ITS MOST AUTHENTIC TASTE.
FOR SOME IT'S A CLIQUE OF CONNOISSEURS,
FOR SOME IT'S A 1 MILLION CLICK COMMUNITY ON FACEBOOK.
FOR SOME IT'S A WOMAN THING,
FOR SOME IT'S A FATHER AND SON THING.

BUT ALL TOGETHER, THESE PEOPLE MAKE UP
THE LARGEST FAMILY OF HUNTERS THAT EVER EXISTED.
BECAUSE IT STRETCHES BACK 500 YEARS,
RIGHT TO THE START OF THE BERETTA DYNASTY.
...IT IS THE BERETTA TRIBE.

BE PART OF THE
#BERETTATRIBE

686 Silver Pigeon I



686 Silver Pigeon I

Built to the usual Beretta high standards, for a price that seems unreal. Available with attractive floral scroll engraving and matt oil finished walnut stock and forend. The tried and tested 680 series action is combined with chrome lined, cold hammer forged barrels, to give you a really reliable gun.

Model	Gauge	Chamber (mm)	Barrel (cm)	Rib (type)	Chokes (type)	Accessories	Drop (mm/mm)	Cast	Pad
686 Silver Pigeon I	12	76	67-71-76	6x6	MC	5 Chokes	36,5/57,5	RH-LH	MicroCore
686 Silver Pigeon I	20	76	67-71-76	6x6	MC	5 Chokes	36,5/57,5	RH-LH	MicroCore
686 Silver Pigeon I	28	70	67-71-76	6x6	MC	5 Chokes	36,5/57,5	RH-LH	MicroCore
686 Silver Pigeon I	410	76	67-71-76	6x6	MC	5 Chokes	36,5/57,5	RH-LH	MicroCore
686 Silver Pigeon I	20/28	76/70	71	6x6	MC	5 Chokes	36,5/57,5	RH-LH	MicroCore
686 Silver Pigeon I	28/410	70/76	71	6x6	MC	5 Chokes	36,5/57,5	RH-LH	MicroCore

Ultralight



Ultralight Classic



Ultralight Gold

Fully featured 12 ga shotguns weighing in at less than a typical 20 ga. The Ultralight's receiver is machined from a single block of remarkably strong aircraft quality aluminum alloy, specially heat treated to deliver the strength and durability of steel, but with 65% of the weight.

Model	Gauge	Chamber (mm)	Barrel (cm)	Rib (type)	Chokes (type)	Accessories	Drop (mm/mm)	Cast	Pad
Ultralight Classic	12	70	62-67-71	6x6	MC, FX (****/**)	5 Chokes	35/55-38/60	RH-LH	Plastic
Ultralight Classic	12	70	62	-	Rifled/MC	5 Chokes	35/55-38/60	RH-LH	Rubber
Ultralight Gold	12	70	62-67-71	6x6	MC, FX (****/**)	5 Chokes	35/55-38/60	RH-LH	Rubber

691



The 691 is an elegant, smooth shooting boxlock shotgun. Beautifully finished, the stock is manufactured from specially selected 2.5 grade walnut, which has been further enriched by Beretta's enhanced oil finishing process. Additionally, the receiver features a unique, floral scroll engraving creating a really handsome gun.

Model	Gauge	Chamber (mm)	Barrel (cm)	Rib (type)	Chokes (type)	Accessories	Drop (mm/mm)	Cast	Pad
691	12	76	66-71-76	6x6	OCHP	5 Chokes	35/55-38/60	RH-LH	MicroCore
691	20	76	66-71-76	6x6	OCHP	5 Chokes	35/55-38/60	RH-LH	MicroCore
691	28	76	66-71-76	6x6	OCHP	5 Chokes	35/55-38/60	RH-LH	MicroCore
691	410	76	66-71-76	6x6	MC	5 Chokes	35/55-38/60	RH-LH	MicroCore

693



693

The traditional Beretta over and under has been combined with the highest technology to create this well balanced, elegant shotgun. The stock is manufactured from specially selected high grade walnut and is oil finished. The action is a modernised development of the tried and tested 680 series. Additionally, the receiver is Nistan finished with exquisite, game scene engraving. Re-engineered Steelium barrels guarantee absolute precision while minimising weight and felt recoil, creating a jewel of a gun.

Model	Gauge	Chamber (mm)	Barrel (cm)	Rib (type)	Chokes (type)	Accessories	Drop (mm/mm)	Cast	Pad
693	12	76	66-71-76	6x6	OCHP	5 Chokes	35/55-38/60	RH-LH	MicroCore
693	20	76	66-71-76	6x6	OCHP	5 Chokes	35/55-38/60	RH-LH	MicroCore
693	12	76	66-71-76	6x6	FX (****/****)	-	35/55-38/60	RH-LH	MicroCore

691 Vittoria

693 Vittoria

The Vittoria series is the first Beretta's shotgun range specifically designed for women. Based on the 690 platform, Vittoria shotguns feature a dedicated ergonomics, suited to those with a shorter stature, youth and ladies, to ensure a smooth, comfortable and precise handling. These guns are fitted with a shortened, semi-Montecarlo style stock, have a reduced pistol grip and additionally are completed by a 1 mm checkering, derived from the premium guns, beneficial for smaller hands.

Model	Gauge	Chamber (mm)	Barrel (cm)	Rib (type)	Chokes (type)	Accessories	Drop (mm/mm)	Cast	Pad
691 Vittoria	12	76	66-71-76	6X6	OCHP	5 Chokes	35/45/55	RH-LH	MicroCore
691 Vittoria	20	76	66-71-76	6X6	OCHP	5 Chokes	35/45/55	RH-LH	MicroCore
693 Vittoria	12	76	66-71-76	6X6	OCHP	5 Chokes	35/45/55	RH-LH	MicroCore
693 Vittoria	20	76	66-71-76	6X6	OCHP	5 Chokes	35/45/55	RH-LH	MicroCore
693 Vittoria	12	76	66-71-76	6x6	FX (****/****)	-	35/45/55	RH-LH	MicroCore



695



Model	Gauge	Chamber (mm)	Barrel (cm)	Rib (type)	Chokes (type)	Accessories	Drop (mm/mm)	Cast	Pad
695	12	76	66-71-76	6x6	OCHP	5 Chokes	35/55-38/60	RH-LH	Wood matched
695	12	76	66-71-76	6x6	FX (****/****)	-	35/55-38/60	RH-LH	Wood matched
695	20	76	66-71-76	6x6	OCHP	5 Chokes	35/55-38/60	RH-LH	Wood matched



695

Polished Optima Bore HP
Steelium barrels

The new 695 is a timeless end elegant field gun, and it is the top of the range in the 690 platform. The engraving on this model is a particularly fine, deep relief scroll made with the most advanced 5 axis premium laser engraving technology, giving the gun a sumptuous feel. With its premium grade three walnut and exquisite engraving on the action, this stunning boxlock shotgun is likely to be highly sought after.

687 EELL Diamond Pigeon



687 EELL Diamond Pigeon Game scene

687 EELL Diamond Pigeon Scroll

The exceptionally strong, low-profile receiver is elegantly adorned with exquisite game scene and intricate scroll engravings, made with the best in class premium laser engraving technology. The stock and fore-end are superior quality walnut embellished with hand cut checkering, demonstrating how improved performance and refined beauty can be perfectly matched.

Model	Gauge	Chamber (mm)	Barrel (cm)	Rib (type)	Chokes (type)	Accessories	Drop (mm/mm)	Cast	Pad
687 EELL Diamond Pigeon	12	76	67-71-76	6x6	MC, FX (****/****)	5 Chokes	35/55-38/60	RH-LH	Wood
687 EELL Diamond Pigeon	20	76	67-71-76	6x6	MC, FX (****/****)	5 Chokes	35/55-38/60	RH-LH	Wood
687 EELL Diamond Pigeon	28	70	67-71-76	6x6	MC	5 Chokes	35/55-38/60	RH	Wood
687 EELL Diamond Pigeon	410	76	67-71	6x6	MC	5 Chokes	35/55-38/60	RH	Wood
687 EELL Diamond Pigeon	20/28	76/70	67-71	6x6	MC	5x2 Chokes	35/55-38/60	RH	Wood
687 EELL Diamond Pigeon	28/410	70/76	67-71	6x6	MC	5x2 Chokes	35/55-38/60	RH	Wood

486 *Parallelo*



Built with a beautifully proportioned, scroll engraved, round body receiver, the 486 is a modern classic in the making. Using a modified demi-block design, Beretta's 'Triblock' system allows for a seamless barrel profile in the best English tradition whilst the V spring mechanism ensures fast, crisp trigger pulls.

Model	Gauge	Chamber (mm)	Barrel (cm)	Rib (type)	Chokes (type)	Accessories	Drop (mm/mm)	Cast	Pad
486 Parallelo	12	76	66-71-76	10x5,5	OCHP	5 Chokes	37/59	RH	Wood
486 Parallelo	12	76	71	10x5,5	FX (***/*) (****/****)	-	37/59	RH	Wood
486 Parallelo	12	76	76	10x5,5	FX (****/****)	-	37/59	RH	Wood
486 Parallelo	20	76	66-71-76	10x5,5	OCHP	5 Chokes	37/59	RH	Wood
486 Parallelo	28	70	71	10x5,5	OCHP	5 Chokes	37/59	RH	Wood
486 Parallelo EL	20	76	66-71-76	10x5,5	OCHP	5 Chokes	37/59	RH	Wood
486 Parallelo EL Color Case	20	76	66-71-76	10x5,5	OCHP	5 Chokes	37/59	RH	Wood



THE 9 REASONS TO CHOOSE THE BERETTA SEMI AUTO TECHNOLOGY

1 PERFECT PATTERNS ON EVERY SHOT.

The ingredients of the stunning accuracy of the Beretta Steellium barrels are: the exclusive tri-alloy Beretta Steel (Ni, Cr, Mo), the deep drilling, the cold hammering process and the vacuum distension. Every OptimaBore HP barrel profile has been specifically designed and tested to provide perfect accuracy with every type of shells: lead, steel and steel High Performance.

4 ALL-LOAD PROVEN RELIABILITY, FROM 24G. TO 64 GR.

Beretta gas-operating system B-Link is world's most reliable system. The closing force is stronger because, when the reloading cycle begins, the energy available to unlock the bolt is significantly higher. Higher energy when opening allows higher closing force, preventing the bolt to unlock when it is not supposed to do it.

7 LOWEST MUZZLE JUMP.

The Beretta semiautomatic shotgun gives you the lowest muzzle jump ever combining the stunning recoil reduction of the Kick-Off devices to the unique ballistic features of the Steellium OptimaBore HP barrels. More control after each shot, better performance for each next one.

2 THE BEST RECOIL REDUCTION.

Kick-Off, Kick-Off³ and Kick-Off Mega ensure you up to 70% recoil reduction giving you more stability, comfort and control for faster target acquisition. More comfort for you, especially when you enjoy shooting hundreds of shots in a single day, and enhanced durability.

5 COMFORT AND EASY TO ASSEMBLE.

The Microcore pad is softer than gel, lighter than rubber and perfectly slipping. It's available in several dimensions to customize your length of pull. The green magazine cap allows a quicker and better safety check on the shotguns magazine. The B-Lok cap, the magazine cap exclusive to Beretta, ensures a perfect and secure closing with just 60 degrees of rotation instead of multiple turns.

8 ERGONOMICS AND EASY TO OPERATE.

The extended bolt handle and bolt release low profile lever allow for easier manipulation during the coldest and rainiest days. An enlarged loading port facilitate an easier and quicker reloading. The new extended lifter avoids thumb bite or glove catch while loading the gun.

3 UNBELIEVABLE RELOADING SPEED (+36%).

The Beretta gas-operated system is fast like an eye's blink. That's why it's called B-Link. The power of the gas-system, combined with the precision of the rotating bolt, ensure you a fast, reliable and smart cycling. You can spend all your magazine's cartridges before the 1st round touches the ground.

6 CLEANER THAN EVER AND EASIER TO CLEAN.

With B-Link, the only weak point of the gas-operating system has been practically reduced to zero. The re-engineering of gas ports and the systematic reduction of all the mechanical frictions the dirt is reduced to the minimum terms. You will experience the lowest maintenance need ever, and a smart, easy, fast and secure cleaning.

9 DESIGNED FOR THE FUTURE, NEVER FORGETTING TRADITION.

The Beretta in-house design team works every day to match design with functionality, giving you original and aesthetically beautiful, simple solutions that optimize the shape, weight and ease of use.

A300 Outlander



A300 Outlander Camo Max5

A300 Outlander Synthetic

A300 Outlander

The A300 Outlander is the latest evolution of Beretta's 300-series gas-operated semiauto shotguns, which have sold by the millions to hunters and sportsmen around the world. And there's a reason for their popularity: unbeatable performance as well as great value out of the box.

Model	Gauge	Chamber (mm)	Barrel (cm)	Rib (type)	Chokes (type)	Accessories	Pad
A300 Outlander Camo MAX-5®	12	76	66-71-76	6x6	MC	I Choke (***)	MicroCore
A300 Outlander Synthetic	12	76	66-71-76	6x6	MC	I Choke (***)	MicroCore
A300 Outlander	12	76	66-71-76	6x6	MC	I Choke (***)	MicroCore



A350 Xtrema Camo Max5



A350 Xtrema Synthetic

Designed for wildfowlers the A350 Xtrema features a 3½" chamber. The proven Beretta gas operating system with self-cleaning piston and cross tube magazine makes this gun super reliable with a wide range of ammo from standard 2¾" target or field loads up to the biggest 3.5" waterfowl magnums. The A350 Xtrema features a cold hammer forged barrel made from Steelium and uses the Optima HP choke system ensuring excellent patterning even with steel shot. Recoil is reduced with a super recoil absorbent, non-stick Micro Core recoil pad and by the built in Kick-Off. Spacers and drop / cast shims are provided.

Model	Gauge	Chamber (mm)	Barrel (cm)	Rib (type)	Chokes (type)	Accessories	Pad
A350 Xtrema Camo MAX-5® KO	12	89	71-76	6x6	OCHP	3 Chokes (*/**/*****)	MicroCore
A350 Xtrema Camo MAX-5®	12	89	71-76	6x6	OCHP	1 Choke (***)	MicroCore
A350 Xtrema Camo Synthetic KO	12	89	71-76	6x6	OCHP	3 Chokes (*/**/*****)	MicroCore
A350 Xtrema Camo Synthetic	12	89	71-76	6x6	OCHP	1 Choke (***)	MicroCore

A400
LITE



A400 Lite Synthetic



A400 Lite Synthetic LH

The Beretta A400 Lite Synthetic is a hunting shotgun that does it all, and that doesn't mind playing hard and getting dirty. It's a 3" semiautomatic shotgun combining the Kick-Off Plus shock absorption with the brand new GunPod 2, the unrivalled Beretta Steelium barrel and a great package of smart, lightweight polymeric solutions.

Fast, versatile, light and low-recoiling, the A400 Lite Synthetic is also self-cleaning, requiring much less maintenance than you can expect. The new A400 Lite Compact is designed to "grow" with the young shooters, featuring a set of spacers and a barrel extension.



A400 Lite Synthetic Max5 - 20 ga.



A400 Lite Compact - 20 ga.

Model	GP2	Gauge	Chamber (mm)	Barrel (cm)	Rib (type)	Chokes (type)	Accessories	Pad
A400 Lite Synthetic	included	12	76	66-71-76	6x6	OCHP	3 Chokes (*/***/*****)	Microcore
A400 Lite Synthetic	-	12	76	66-71-76	6x6	OCHP	3 Chokes (*/***/*****)	Microcore
A400 Lite Synthetic	included	20	76	66-71-76	6x6	OCHP	3 Chokes (*/***/*****)	Microcore
A400 Lite Compact	included	20	76	66-71-76	6x6	OCHP	2 Chokes (****/** Extended)	Microcore
A400 Lite Synthetic Left Handed	-	12	76	66-71-76	6x6	OCHP	3 Chokes (*/***/*****)	Microcore
A400 Lite Synthetic Left Handed	Included	12	76	66-71-76	6x6	OCHP	3 Chokes (*/***/*****)	Microcore
A400 Lite Camo MAX-5®	Included	20	76	66-71-76	6x6	OCHP	3 Chokes (*/***/*****)	Microcore



A400 Xtreme PLUS



Model	Gauge	Chamber (mm)	Barrel (cm)	Rib (type)	Chokes (type)	Accessories	Pad
A400 Xtreme Plus Synthetic	12	89	66-71-76	7x7	OCHP	(*/**/****/****/****) Ext. Black Edition	MicroCore
A400 Xtreme Plus Camo MAX-5	12	89	66-71-76	7x7	OCHP	(*/**/****/****/****) Ext. Black Edition	MicroCore
A400 Xtreme Plus Camo Mossy Oak Bottomland	12	89	66-71-76	7x7	OCHP	(*/**/****/****/****) Ext. Black Edition	MicroCore



Xtreme preparations, Xtreme conditions, Xtreme expectations. The new A400 Xtreme Plus is built to go wherever your hunt takes you. Engineered to be the softest-shooting, most reliable 3.5" waterfowl shotgun out there, and to withstand the toughest waterfowl environments. It has and the best recoil reduction system in the world, combining the Kick-Off Mega and Kick-Off³ together with the new soft comb, which reduces the felt recoil imparted to the shooter's cheek even further. It features the best barrel technology drawing from the Olympic competition world, Beretta's exclusive Steelium Plus barrels, providing the best patterning possible from all hunting loads. An extended charging handle and bolt release from the factory allow for easier manipulation during the coldest and rainiest days.

An enlarged loading port allows for ease of loading. The new A400 Xtreme Plus shoots always, shoots everything and shoots even better!

A400 Xplor ACTION

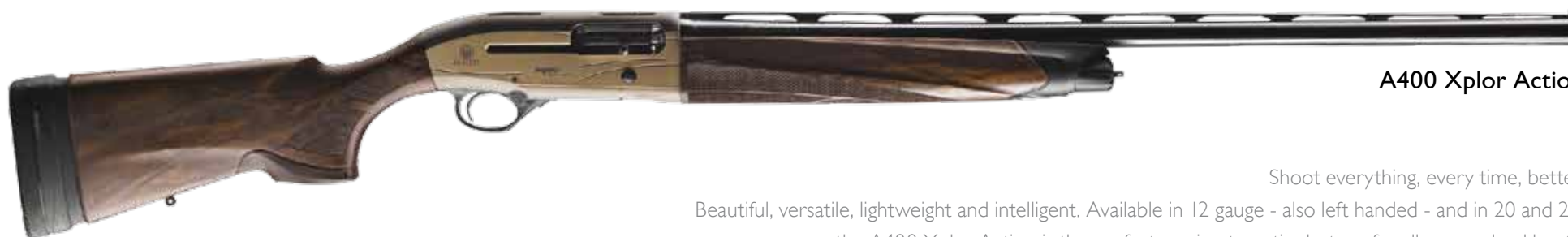

A400 Xplor Action

Shoot everything, every time, better. Beautiful, versatile, lightweight and intelligent. Available in 12 gauge - also left handed - and in 20 and 28, the A400 Xplor Action is the perfect semi-automatic shotgun for all your upland hunts.

Model	GP2	Gauge	Chamber (mm)	Barrel (cm)	Rib (type)	Chokes (type)	Accessories	Pad
A400 Xplor Action	Ready for	12	76	66-71-76	6x6	OCHP	3 Chokes (*/*/*/*/*/*/*/*)	MicroCore
A400 Xplor Action	-	20	76	61-66-71-76	6x6	OCHP	3 Chokes (*/*/*/*/*/*/*/*)	MicroCore
A400 Xplor Action	-	28	70	66-71	5x5	OCHP	3 Chokes (*/*/*/*/*/*/*/*)	MicroCore
A400 Xplor Action	Included	12	76	66-71-76	6x6	OCHP	3 Chokes (*/*/*/*/*/*/*/*)	MicroCore
A400 Xplor Action KO	Ready for	12	76	66-71-76	6x6	OCHP	3 Chokes (*/*/*/*/*/*/*/*)	MicroCore
A400 Xplor Action KO	Included	12	76	66-71-76	6x6	OCHP	3 Chokes (*/*/*/*/*/*/*/*)	MicroCore
A400 Xplor Action Left-Handed	Ready for	12	76	66-71-76	6x6	OCHP	3 Chokes (*/*/*/*/*/*/*/*)	MicroCore
A400 Xplor Action Left-Handed	Included	12	76	66-71-76	6x6	OCHP	3 Chokes (*/*/*/*/*/*/*/*)	MicroCore
A400 Xplor Action Left-Handed KO	Ready for	12	76	66-71-76	6x6	OCHP	3 Chokes (*/*/*/*/*/*/*/*)	MicroCore
A400 Xplor Action Left-Handed KO	Included	12	76	66-71-76	6x6	OCHP	3 Chokes (*/*/*/*/*/*/*/*)	MicroCore
A400 Xplor Action Slug	Ready for	12	76	56-61	-	FX (CL) or (*/*/*/*/*)	-	MicroCore
A400 Xplor Action Slug	Included	12	76	56-61	-	FX (CL) or (*/*/*/*/*)	-	MicroCore
A400 Xplor Action KO Slug	Ready for	12	76	56-61	-	FX (CL) or (*/*/*/*/*)	-	MicroCore
A400 Xplor Action KO Slug	Included	12	76	56-61	-	FX (CL) or (*/*/*/*/*)	-	MicroCore

A400
ultra **LITE**



A400 Ultralite

Much more than light, Ultralite.
The 3" semiautomatic shotgun with full-length carbon-fiber top rib and carbon-fiber pistol grip cap, bringing weight down to 2,7 Kg without shortening the magazine capacity. Black anodized aluminium-alloy receiver with technological laser engraving and super-lightweight woods. Simply amazing.

Model	Gauge	Chamber (mm)	Barrel (cm)	Rib (type)	Chokes (type)	Accessories	Pad
A400 Ultralite	12	76	61-66-71	6x6 Carbon fiber	OCHP	3 Chokes (*/**/*****)	MicroCore

A400
Upland



Wood Kick-Off Plus

3" Chamber

Game scene
Nickel Finish Receiver

New design of pistol
grip with improved
checkering

Model	Gauge	Chamber (mm)	Barrel (cm)	Rib (type)	Chokes (type)	Accessories	Pad
A400 Upland	12	76	66-71-76	6x6	OCHP	3 Chokes (*/***/*****)	MicroCore

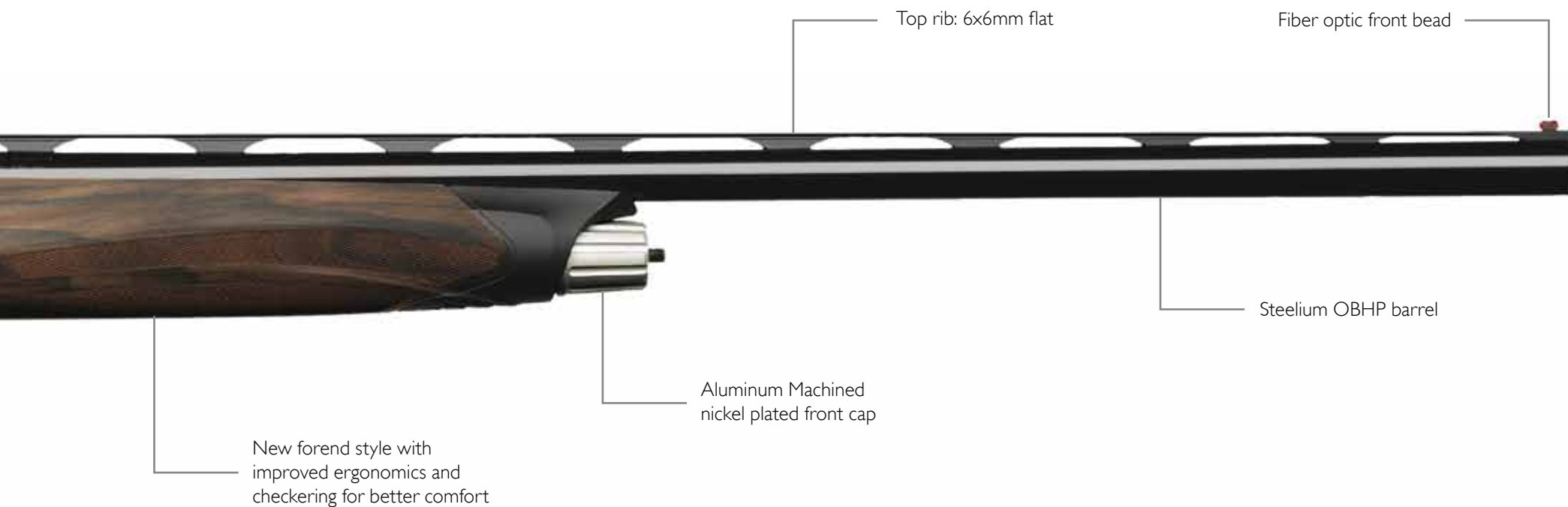

The A400 Upland is the very first Beretta shotgun featuring an innovative wood stock with the Kick-Off Plus technology, that reduces recoil up to 50%. The nickel plated receiver is completed by an exquisite game scene engraving. The new design of the pistol grip and forend improves the gun comfort and enhances the overall look and slim new design. The A400 Upland is a great combination of the latest technologies with a classic look, for all the hunters that are looking for the best shooting experience.

EVERY BIG WIN IS MADE OF SMALL VICTORIES

Behind every smashed clay there is a wealth of details that have been studied and developed with the world's no. 1 shooters. So, every detail of your shotgun, clothing, and accessories will really make a difference the next time you step onto the shooting field. Tag your passion for shooting with

#1CHOICEOFCHAMPIONS



**THE N°1 CHOICE
OF CHAMPIONS**



Hand fitting by Beretta Premium Gunsmiths

Factory Balance

Interchangeable Barrel Shoulders

Hand-engraved anti-glare finishing

B-Fast Balance

Protection against the sun reflection

Inner sweatband

High grade selected walnut stock

Perfectly adjustable

Maximum perception during the shoot

Designed on the shooter's movements

Reduced felt recoil

Technical fabric

Microcore® recoil pad

Fast and precise shouldering

Easy customizable

Reduced muzzle rise

Barrell accuracy 100% tested

Steelium Pro barrel

Cold hammer forging

Proprietary tri alloyed steel

Improved pattern distribution

Smoother swing

Modified single base ribs for better heat dissipation

Center-mass low and coaxial

18 inches forcing cone

Vacuum distension

Wide receiver Deep drilling

Detachable trigger group

V-spring trigger group

Adjustable trigger

No itch

Extremely breathable

Protection, perception and freedom

Excellent breathability

Badge chest

Perfect fit

Earmuff/towel binding on both sides

686 Silver Pigeon I Sporting



686 Silver Pigeon I Sporting

Built to the usual Beretta, high standards, for a price that seems unreal. Available with an attractive floral scroll engraving and matt oil finished walnut stock and forend. The tried and tested 680 series action is combined with chrome lined, cold hammer forged barrels, to give you a really reliable gun. The Optima HP Steelium barrels and chokes throw superb patterns with reduced recoil. The 2 grade walnut stock is also fitted with a micro core pad as standard. A feature rich, competition shotgun.

Model	Gauge	Chamber (mm)	Barrel (cm)	Rib (type)	Chokes (type)	Accessories	Drop (mm/mm)	Cast	Forend
686 Silver Pigeon I Sporting	12	76	71-76-81	10x8	OCHP	5 Chokes	36,5/57,5	RH-LH	Schnabel
686 Silver Pigeon I Sporting (B-Fast)	20	76	76	8x8	MC	5 Chokes	38/60	RH-LH	Schnabel
686 Silver Pigeon I Sporting (B-Fast)	28	70	76	8x8	MC	5 Chokes	38/60	RH-LH	Half Beavertail
686 Silver Pigeon I Sporting (B-Fast)	410	76	76	8x8	MC	5 Chokes	38/60	RH-LH	Half Beavertail

687 EELL Diamond Pigeon Sporting



687 EELL Diamond Pigeon Sporting

The exceptionally strong, low-profile receiver is elegantly adorned with exquisite game scene or intricate scroll engravings made with the best in class premium laser engraving technology. The stock and fore-end are superior quality walnut embellished with hand cut checkering, demonstrating how improved performance and refined beauty can be perfectly matched.

Model	Gauge	Chamber (mm)	Barrel (cm)	Rib (type)	Chokes (type)	Accessories	Drop (mm/mm)	Cast	Forend
687 EELL Diamond Pigeon Sporting	12	76	76-81	10x8	MC	5 Chokes	35/55 - 38/60	RH-LH	Schnabel

691 | VITTORIA



691 Sporting



691 Sporting Vittoria

The 691 is an elegant, smooth shooting boxlock shotgun. Beautifully finished, the stock is manufactured from specially selected 2.5 grade walnut, which has been further enriched by Beretta's enhanced oil finishing process.

Additionally, the receiver features a unique, floral scroll engraving creating a really handsome gun.

The shotgun is available also in the Vittoria version, featuring a dedicated ergonomics, suited to those with a shorter stature, youth and ladies, to ensure a smooth, comfortable and precise handling.

Model	Gauge	Chamber (mm)	Barrel (cm)	Rib (type)	Chokes (type)	Accessories	Drop (mm/mm)	Cast	Forend
691 Sporting	12	76	71-76-81	10x8	OCHP	5 Chokes	35/55	RH-LH	Schnabel-Rounded
691 Sporting Vittoria	12	76	71-76-81	10x8	OCHP	5 Chokes	35/45/55	RH-LH	Schnabel

693 Sporting

693 Sporting Vittoria

The traditional Beretta over and under has been combined with the highest technology to create this well balanced, elegant shotgun. The stock is manufactured from specially selected high grade walnut and is oil finished. The action is a modernised development of the tried and tested 680 series. Additionally, the receiver is Nistan finished with exquisite, gamescene engraving. Re-engineered Steelium barrels guarantee absolute precision while minimising weight and felt recoil, creating a jewel of a gun.

The shotgun is available also in the Vittoria version, featuring a dedicated ergonomics, suited to those with a shorter stature, youth and ladies, to ensure a smooth, comfortable and precise handling.

Model	Gauge	Chamber (mm)	Barrel (cm)	Rib (type)	Chokes (type)	Accessories	Drop (mm/mm)	Cast	Forend
693 Sporting	12	76	71-76-81	OCHP	5 Chokes	10x8	35/55	RH-LH	Schnabel-Rounded
693 Sporting Vittoria	12	76	71-76-81	OCHP	5 Chokes	10x8	35/45/55	RH-LH	Rounded

690



690 Black Edition Sporting

690 Sporting and Trap are the competition over and unders to make your quantum leap in shooting performance.

Thanks to the Steelium barrel and to the outstanding balance, the 690 competition shotguns provide accuracy, ease of handling and perfect control. Exactly what you need when you start aiming to your first 25.

Model	Gauge	Chamber (mm)	Barrel (cm)	Rib (type)	Chokes (type)	Accessories	Drop (mm/mm)	Cast	Forend
690 Black Edition Sporting	12	76	71-76-81	10x8	OCHP	5 Chokes, Extended	35/55-38/60	RH-LH	Schnabel-Rounded
690 Black Edition Sporting (B-Fast)	12	76	71-76-81	10x8	OCHP	5 Chokes, Extended	-	RH-LH	Schnabel-Rounded
690 Black Edition Trap	12	70	76-81	10x10	FX (**/*)	-	29/39-32/42-35/45	RH-LH	Schnabel-Rounded
690 Black Edition Trap (B-Fast)	12	70	76-81	10x10	FX (**/*)	-	-	RH-LH	Schnabel-Rounded

692



692 Trap B-Fast



692 Black Edition Sporting

The 692 offers you the highest level of performance to shoot like a star. Perfect pattern distribution and reduced muzzle raise thanks to the new Steelium Plus barrel, smooth and precise handling thanks to the wider receiver and to the new B-Fast balance system.

Model	Gauge	Chamber (mm)	Barrel (cm)	Rib (type)	Chokes (type)	Accessories	Drop (mm/mm)	Cast	Forend
692 Skeet	12	76	73	10x8	OCHP	5 Chokes	35/55-38/60	DX-SX	Rounded
692 Skeet (B-Fast)	12	76	73	10x8	OCHP	5 Chokes	-	DX-SX	Rounded
692 Sporting	12	76	71-76-81	10x8	OCHP	5 Chokes, Extended	35/55-38/60	DX-SX	Schnabel-Rounded
692 Sporting (B-Fast)	12	76	71-76-81	10x8	OCHP	5 Chokes, Extended	-	DX-SX	Schnabel-Rounded
692 Black Edition Sporting	12	76	71-76-81	10x10 Carbon fiber	OCHP	5 Chokes, Extended	35/55-38/60	DX-SX	Schnabel-Rounded
692 Black Edition Sporting (B-Fast)	12	76	71-76-81	10x10 Carbon fiber	OCHP	5 Chokes, Extended	-	DX-SX	Schnabel-Rounded
692 Trap	12	70	76-81	10x10	FX (**/*)	-	29/39-32/42-35/45	DX-SX	Schnabel-Rounded
692 Trap (B-Fast)	12	70	76-81	10x10	FX (**/*)	-	-	DX-SX	Schnabel-Rounded
692 Black Edition Trap	12	70	76-81	10x10 Carbon fiber	FX (**/*)	-	29/39-32/42-35/45	DX-SX	Schnabel-Rounded
692 Black Edition Trap (B-Fast)	12	70	76-81	10x10 Carbon fiber	FX (**/*)	-	-	DX-SX	Schnabel-Rounded

DT11

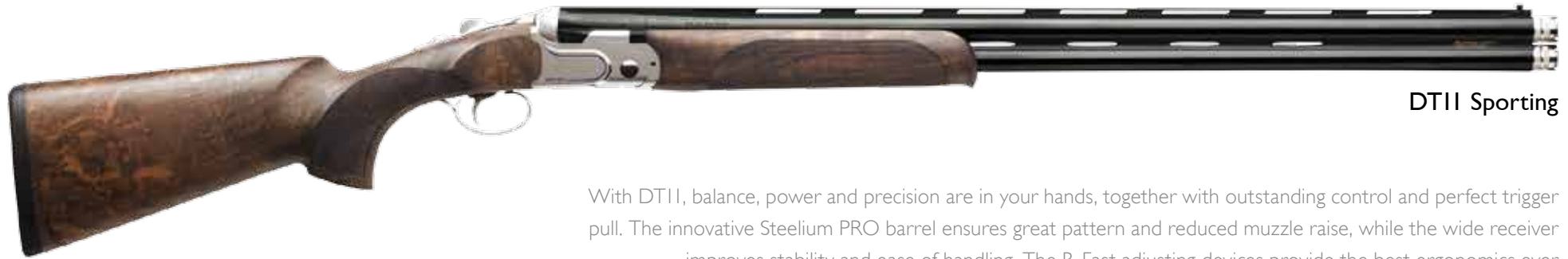

DT11 Sporting

With DT11, balance, power and precision are in your hands, together with outstanding control and perfect trigger pull. The innovative Steelium PRO barrel ensures great pattern and reduced muzzle raise, while the wide receiver improves stability and ease of handling. The B-Fast adjusting devices provide the best ergonomics ever to assist you in hitting every time a target more.

Model	Gauge	Chamber (mm)	Barrel (cm)	Rib (type)	Chokes (type)	Accessories	Drop (mm/mm)	Cast	Forend
DT11 Sporting	12	76	71-76-81	10x8	OCHP	5 Chokes	35/56-38/60-Headed	RH-LH	Schnabel-Rounded
DT11 Sporting (B-Fast)	12	76	71-76-81	10x8	OCHP	5 Chokes	-	RH-LH	Schnabel-Rounded
DT11 Skeet	12	70	71-73	10x8	OCHP	5 Chokes	35/56-38/60	RH-LH	Schnabel-Rounded
DT11 Skeet (B-Fast)	12	70	73	10x8	OCHP	5 Chokes	-	RH-LH	Schnabel-Rounded
DT11 Trap	12	70	75-76	10x10	**/*	5 Chokes	29/39-32/42-34/44-Headed	RH-LH	Beavertail-Rounded
DT11 Trap (B-Fast)	12	70	75-76	10x10	**/*	5 Chokes	-	RH-LH	Beavertail-Rounded
DT11 ACS (B-Fast)	12	76	76-81	10x8 Adjustable	OCHP	5 Chokes	Montecarlo Ad.	RH-LH	Schnabel-Rounded
DT11 XTrap (B-Fast)	12	76	76-81	Adjustable	OCHP	5 Chokes	Montecarlo Ad.	RH-LH	Beavertail-Rounded
DT11 L Sporting Floral	12	76	71-76-81	10x8	OCHP	5 Chokes	35/56-38/60-Headed	RH-LH	Schnabel-Rounded
DT11 L Sporting Floral (B-Fast)	12	76	71-76-81	10x8	OCHP	5 Chokes	-	RH-LH	Schnabel-Rounded
DT11 L Sporting Game scene	12	76	71-76-81	10x8	OCHP	5 Chokes	35/56-38/60-Headed	RH-LH	Schnabel-Rounded
DT11 L Sporting Game scene (B-Fast)	12	76	71-76-81	10x8	OCHP	5 Chokes	-	RH-LH	Schnabel-Rounded
DT11 LTrap Floral	12	70	75-76	10x10	**/*	-	29/39-32/42-34/44-Headed	RH-LH	Beavertail-Rounded
DT11 LTrap Floral (B-Fast)	12	70	75-76	10x10	**/*	-	-	RH-LH	Beavertail-Rounded
DT11 EELL Sporting	12	76	71-76-81	10x8	OCHP	5 Chokes	35/56-Headed	RH-LH	Rounded
DT11 EELL Sporting (B-Fast)	12	76	71-76-81	10x8	OCHP	5 Chokes	-	RH-LH	Rounded
DT11 EELL Trap	12	70	75-76	10x10	**/*	-	29/39-32/42-Headed	RH-LH	Rounded
DT11 EELL Trap (B-Fast)	12	70	75-76	10x10	**/*	-	-	RH-LH	Rounded





DT11 Black Edition Sporting



DT11 Black Edition Skeet

DT11 Black. The highest expression of the Beretta competition over and under, now in a black and hyper-technological edition. Carbon fibre top rib, carbon fibre trigger plate and the most complete B-Fast ever, now featuring both stock and barrel balancing system. The choice of the champions, now in Black Edition.

Model	Gauge	Chamber (mm)	Barrel (cm)	Rib (type)	Chokes (type)	Accessories	Drop (mm/mm)	Cast	Forend
DT11 Black Edition Sporting	12	76	76-81	10x10 Carbon fiber	OCHP	5 Chokes	35/56-38/60-Headed	RH-LH	Schnabel-Rounded
DT11 Black Edition Sporting (B-Fast)	12	76	76-81	10x10 Carbon fiber	OCHP	5 Chokes	-	RH-LH	Schnabel-Rounded
DT11 Black Edition Trap	12	70	76-81	10x10 Carbon fiber	**/*	-	32/42-Headed	RH-LH	Rounded
DT11 Black Edition Trap (B-Fast)	12	70	76-81	10x10 Carbon fiber	**/*	-	-	RH-LH	Rounded
DT11 Black Edition Skeet	12	70	76	10x10 Carbon fiber	OCHP	5 Chokes	Headed	RH-LH	Rounded
DT11 Black Edition Skeet (B-Fast)	12	70	76	10x10 Carbon fiber	OCHP	5 Chokes	-	RH-LH	Rounded

DT 11 BLACKPRO



Model	Gauge	Chamber (mm)	Barrel (cm)	Rib (type)	Chokes (type)	Accessories	Drop (mm/mm)	Cast	Forend
DT 11 Black Pro Trap	12	70	76	10x10 Carbon fiber	**/**	-	-	RH-LH, Size L	Rounded
DT 11 Black Pro Skeet	12	70	76	10x10 Carbon fiber	OCHP	5 Chokes	-	RH-LH, Size L	Rounded
DT 11 Black Pro Sporting	12	76	81	10x10 Carbon fiber	OCHP	5 Chokes	-	RH-LH, Size L	Rounded

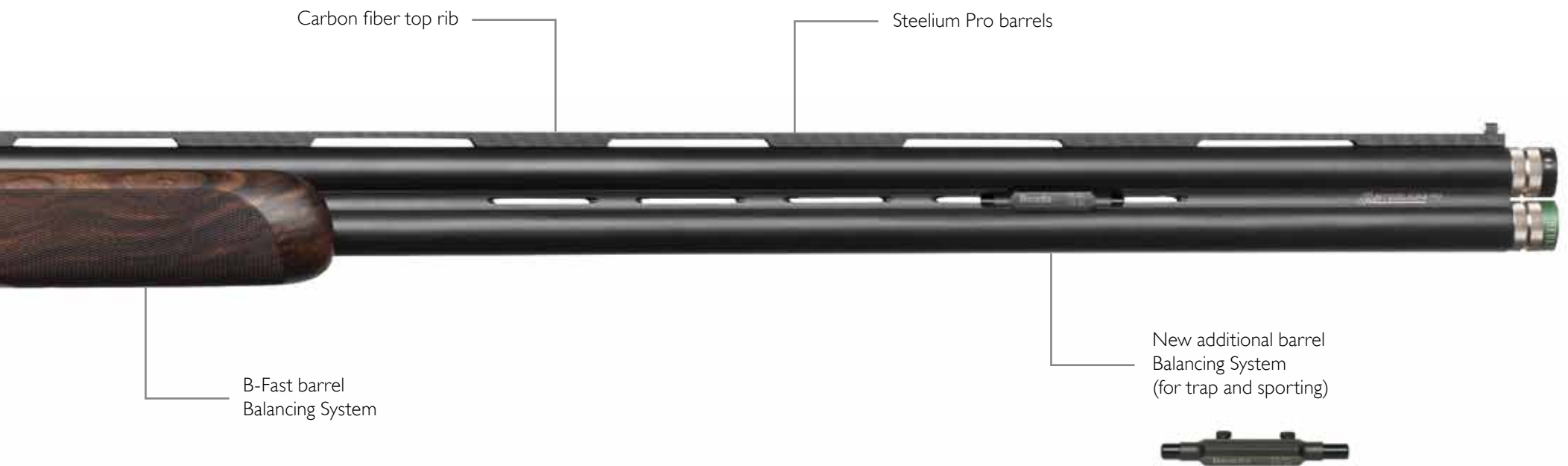

The DT11 Black Pro stems from the collaboration with the Beretta Shooting Team champions to offer all shooters the maximum possibility of customizing the balancing and the fitting of the stock. The DT11 Black Pro keeps all the features which made the DT11 black an outstanding success since its introduction on the market, with the addition of two removable weights for the muzzle and the new fully adjustable stock for trap, skeet and sporting that Beretta has developed with TSK®. The Beretta by TSK® stock perfectly fits the anatomy of every shooter and helps him finding the best set up by adjusting the comb, the cast, the length of pull, and the pitch in an extremely simple, immediate and always reversible way.

A400 Xcel



A400 Xcel Sporting Black



A400 Xcel Multitarget

The purest shooting passion, powered by technological precision. The A400 Xcel is the most advanced competition semiautomatic shotgun by Beretta, featuring B-link, Kick-Off, MicroCore, Steelium, Optimabore HP, and a balance cap.

Model	Gauge	Chamber (mm)	Barrel (cm)	Rib (type)	Chokes (type)	Accessories	Cast	Pad
A400 Xcel Multitarget (B-Fast)	12	76	71-76-81	Adjustable	OCHP	3 Chokes (**/**/**)	RH-LH	Microcore
A400 Xcel Multitarget Kick-Off (B-Fast)	12	76	71-76-81	Adjustable	OCHP	3 Chokes (**/**/**)	RH-LH	Microcore
A400 Xcel Parallel Target	12	76	71-76-81	10x8 with step	OCHP	3 Chokes (**/**/**)	RH-LH	MicroCore
A400 Xcel Sporting (Ready for GunPod)	12	76	71-76-81	10x8	OCHP	3 Chokes (**/**/**)	RH-LH	MicroCore
A400 Xcel Sporting (with GunPod 2)	12	76	71-76-81	10x8	OCHP	3 Chokes (**/**/**)	RH-LH	MicroCore
A400 Xcel Sporting	20	76	71-76-81	10x8	OCHP	3 Chokes (**/**/**)	RH-LH	MicroCore
A400 Xcel Sporting Kick-Off (with GunPod 2)	12	76	71-76-81	10x8	OCHP	3 Chokes (**/**/**)	RH-LH	MicroCore
A400 Xcel Sporting Black (Ready for GunPod)	12	76	71-76-81	10x10 Carbon fiber	OCHP	3 Chokes Black Edition (**/**/**)	RH-LH	MicroCore
A400 Xcel Sporting Black Kick-Off (Ready for GunPod)	12	76	71-76-81	10x10 Carbon fiber	OCHP	3 Chokes Black Edition (**/**/**)	RH-LH	MicroCore

1301 Comp



The I301 Comp is 36% faster than any other semiautomatic shotgun. It provides an outstanding technical package for 3-Gun matches and practical shooting, including extended magazine capacity, new oversized controls and easy ammunition loading. Speed, precision and reliability, specifically designed for practical shooting.

Model	Gauge	Chamber (mm)	Barrel (cm)	Rib (type)	Chokes (type)	Accessories	Cast	Pad
I301 Comp	12	76	53,5	10x8 with step	OCHP	1 Choke (****/IC)	RH-LH	MicroCore
I301 Comp	12	76	61	10x8 with step	OCHP	1 Choke (****/IC)	RH-LH	MicroCore

IN 1915 BERETTA LAUNCHES
ITS FIRST SEMIAUTOMATIC PISTOL.
DIFFERENT GENERATIONS OF BERETTA HANDGUNS
HAVE GONE THROUGH ALL THE GREAT CHALLENGES
OF THE LAST CENTURY.
TODAY, WITH MORE THAN A HUNDRED YEARS
OF EXPERIENCE IN THE FIELD, THE NEW PLATFORMS
ARE BORN WITH A CLEAR AWARENESS
OF THE NEEDS OF TACTICAL AND COMPETITION USERS
AND WITH CONSTANT ATTENTION
TO THE NEW FRONTIERS OF INNOVATION.

BERETTA TACTICAL PRODUCTS ARE
DEVELOPED, TESTED, AND BUILT
FOR THOSE WHO COME PREPARED TO WIN.
TRAIN WITH PASSION TO

#WINTHEFIGHT



TRAIN
— WITH —
PASSION

APX



APX



APX Tactical

Designed specifically for military and law enforcement operators, the APX has been put through extensive testing and evaluation at the professional end user level. The result is a pistol that delivers superior performance in durability and reliability, ergonomics, trigger, and modularity. Utilizing a removable, serialized chassis frame, the APX can be easily modified with replaceable grip frame housings and is simple to disassemble and maintain. Each APX comes with 3 interchangeable back straps so users can best fit their hands and preferences. The APX's aggressive full length slide serrations make slide manipulations easy under any conditions. To accommodate right or left-handed use, the APX's magazine release button can be easily reversed, and the slide stop is ambidextrous. The APX's trigger breaks at 6lbs and has a clear tactile and audible very short reset.

The APX truly is the ultimate striker fired pistol from Beretta. Now available in different colors and in the new RDO and Combat versions



APX RDO



APX Combat

Model	Gauge	Action	Additional Magazines	Magazine Capacity (rounds)	Weight Unloaded (g)	Total Length (mm)	Barrel Length (mm)	Width (mm)	Height (mm)	Safety Position	Grips
APX	9x19	Striker	1	17	800	192	108	33	142	Trigger	Plastic
APX	40 S&W	Striker	1	15	820	192	108	33	142	Trigger	Plastic
APX Tactical	9x19	Striker	1	17	800	192	108	33	142	Trigger	Plastic
APX Combat	9x19	Striker	1	17	820	208	125	33	142	Trigger	Plastic
APX RDO	9x19	Striker	1	17	820	192	108	33	142	Trigger	Plastic

APX CENTURION



The APX Centurion pistol extends the proven APX Series to a mid-size duty or concealed carry size. It features a 15+1 (9mm) or 13+1 (.40 S&W) flush fit magazine. As with all APX pistols, the APX Centurion has been designed specifically for military and law enforcement users who have a need for a smaller pistol with similar handling characteristics to their duty pistols. The APX Centurion features a removable serialized chassis and can be easily modified with replaceable grip frame housings. Controllability and ergonomics are an APX focus: low bore axis, ambidextrous slide catch, reversible magazine release, aggressive slide serrations, and a really smooth trigger with a clear tactile and audible short reset.

Model	Gauge	Action	Additional Magazines	Magazine Capacity (rounds)	Weight Unloaded (g)	Total Length (mm)	Barrel Length (mm)	Width (mm)	Height (mm)	Safety Position	Grips
APX Centurion	9x19	Striker	1	15	765	177	94	33	132	Trigger	Plastic
APX Centurion	.40	Striker	1	13	785	177	94	33	132	Trigger	Plastic



The APX Compact pistol extends the proven APX Series to a concealed carry friendly size. It features a 13+1 (9mm) or 10+1 (.40 S&W) flush fit magazine and can accept the Full/Centurion size APX magazines as well. As with all APX pistols, the Compact has been designed for those who have a need to carry concealed but want similar handling characteristics to their duty pistols. The APX Compact features a removable serialized chassis and it can be easily modified by switching to the Centurion 10 mm higher frame. Replaceable backstraps are also available to further customize your Compact. Controllability and ergonomics are an APX focus: low bore axis, ambidextrous slide catch, reversible magazine release, aggressive slide serrations, and a really smooth trigger with a clear tactile and audible short reset.

Model	Gauge	Action	Additional Magazines	Magazine Capacity (rounds)	Weight Unloaded (g)	Total Length (mm)	Barrel Length (mm)	Width (mm)	Height (mm)	Safety Position	Grips
APX Compact	9x19	Striker	1	13	750	177	94	33	122	Trigger	Plastic
APX Compact	.40	Striker	1	11	770	177	94	33	122	Trigger	Plastic



Px4



Px4 Storm
Inox



Px4 Storm
Special Duty



Px4 Storm
Deluxe



Px4 Storm
Compact



Px4 Storm
Compact Inox



Px4 Storm
SubCompact





Px4 Storm Full size



Absolute durability, reliability, and ergonomics have made it the go-to choice for shooters around the world. Designed to meet the most stringent military standards of durability, the PX4 has been reported to fire well over 150,000 rounds with zero part breakage.

The lines of the pistol are snag-free and make unholstering and reholstering easy and fluid. The pistol may be adapted to different hand sizes and shooting styles thanks to a modular design with interchangeable backstraps. The ambidextrous and reversible controls offer the possibility of easily training or shooting with either hand.

Besides being one of the strongest actions available, the rotary barrel dissipates recoil away from the shooter's hand and greatly reduces muzzle jump, making it an extremely fast and accurate action.

Disassembly is designed to allow for quick field stripping.

Model	Gauge	Action	Additional Magazines	Magazine Capacity (rounds)	Weight Unloaded (g)	Total Length (mm)	Barrel Length (mm)	Width (mm)	High (mm)	Safety Position	Grips
PX4 Storm Type F	9x19	S - D	1	17	785	192	102	36	140	Slide	Int. Backstrap
PX4 Storm Type G	9x19	S - D	1	17	785	192	102	36	140	LAC	Int. Backstrap
PX4 Storm Inox	9x19	S - D	1	17	785	195	102	36	140	Slide	Int. Backstrap
PX4 Storm Deluxe	9x19	S - D	1	17	785	192	102	36	140	Slide	Int. Backstrap
PX4 Storm Compact Type F	9x19	S - D	1	15	770	173	83	36	129	Slide	Int. Backstrap
PX4 Storm Compact Inox	9x19	S - D	1	15	770	173	83	36	129	Slide	Int. Backstrap
PX4 Storm SubCompact Type F	9x19	S - D	1	13	740	158	76	36	122	Slide	Int. Backstrap
PX4 Storm Type F	.40 S&W	S - D	1	14	810	192	102	36	140	Slide	Int. Backstrap
PX4 Storm Type G	.40 S&W	S - D	1	14	810	192	102	36	140	LAC	Int. Backstrap
PX4 Storm Inox	.40 S&W	S - D	1	14	785	192	102	36	140	Slide	Int. Backstrap
PX4 Storm Compact Type F	.40 S&W	S - D	1	12	770	173	83	36	129	Slide	Int. Backstrap
PX4 Storm Type F	45 ACP	S - D	1	9-10	800	195	102	36	140	Slide	Int. Backstrap
PX4 Storm Special Duty *	45 ACP	S - D	2	9-10	820	210	115	36	145	Slide	Int. Backstrap



M9A3



Model	Gauge	Action	Additional Magazines	Magazine Capacity (rounds)	Weight Unloaded (g)	Total Length (mm)	Barrel Length (mm)	Width (mm)	Height (mm)	Safety Position	Grips
M9A3	9x19	S - D	1	17	944	220	129,5	38	137	Slide	Plastic
M9A3 Black	9x19	S - D	1	17	944	220	129,5	38	137	Slide	Plastic

M9A3



M9A3

With the M9A3 semiauto pistol series, Beretta has created a coming-together of all the tactical and functional features that today's combat professionals may require. From Vertec-style thin grip for instinctive pointability, to universal slide design convertible from safety-decocker to decocker-only, from a bevelled magazine well to oversize mag-release button, from a 3-slot built-in Picatinny rail to high-capacity capability for maximum firepower. These combat pistols were designed to be perfect for any tactical use, including home and personal defence, tactical competitions as well as duty carry in any condition.

M9A1



Model	Gauge	Action	Additional Magazines	Magazine Capacity (rounds)	Weight Unloaded (g)	Total Length (mm)	Barrel Length (mm)	Width (mm)	Height (mm)	Safety Position	Grips
M9A1	9x19	S - D	1	17	945	217	125	38	143	Slide	Plastic
M9A1 Compact Inox	9x19	S - D	1	13	895	197	125	38	133	Slide	Plastic
M9A1 Compact Black	9x19	S - D	1	13	895	197	125	38	133	Slide	Plastic

M9A1



M9A1
Compact Inox



M9A1
Compact Black

Developed to meet the demanding requirements of the US Corps, the M9A1 incorporates the established reliability and performance of the M9, with added features needed for the ever-changing missions of peacekeeping forces. Thanks to its accuracy, durability and versatility, it also makes a superb choice for personal or home defense as well as concealed carry.

The M9A1 is built to be ultra-tough and always dependable. Besides the superior steels of which it is constructed, it also features a unique sand-resistant magazine and a special PVD coating. At the range, the M9A1 will impress you for its low recoil, as well as its accuracy.

90 Series



92 FS

The Beretta 92FS has been setting the standards for best military, police and tactical pistol for over a quarter century.

The reason is that it was designed, and has kept evolving to be and remain the most accurate, durable and reliable semiauto handgun on the market. Easy to use, absolutely safe and delivering impressive firepower, it remains the sidearm of allied forces the world over, as well as of countless police and law-enforcement agencies.

Model	Gauge	Action	Additional Magazines	Magazine Capacity (rounds)	Weight Unloaded (g)	Total Length (mm)	Barrel Length (mm)	Width (mm)	Height (mm)	Safety Position	Grips
92 FS	9x19	S - D	1	15	945	217	125	38	143	Slide	Plastic
92 FS Inox	9x19	S - D	1	15	945	217	125	38	143	Slide	Rubber
92 FS Centennial	9x19	S	1	15	1.350	217	125	38	143	Frame	Wood
92 AI	9x19	S - D	1	17	945	217	125	38	143	Slide	Plastic
92 FS 22LR	22 LR	S - D	-	15	740	217	135	38.6	140	Slide	Plastic

90 Series



92 FS Inox



92 FS
Centennial



92 AI



92 FS 22LR

1301 TACTICAL



1301 Tactical

The 1301 is Beretta's new gas operated semi-automatic shotgun engineered to be ultra-reliable and easy to use. Thanks to its compact size, it is ideal for negotiating tight spaces. It has all the features that a modern tactical shotgun should offer and it is easily adaptable to most users' needs, body type and shooting posture. Right out of the box, the 1301 Tactical features an oversized charging handle, large textured bolt release and an oversized reversible safety button. Although perfect out of the box, this tactical shotgun The integrated B-LINK gas operating system, featuring a cross tube gas piston, allows the 1301 Tactical to cycle 36% faster than any other shotgun on the market. This also makes it ideal for three-gun competitions.

Model	Gauge	Chamber (mm)	Barrel (cm)	Sights (mm)	Chokes (type)	Accessories	Pad
1301 Tactical	12	76	47,5	Ghost Ring	OCHP or FX (CL/*****)	Stock spacers	Rubber
1301 Tactical FDE	12	76	47,5	Ghost Ring	OCHP or FX (CL/*****)	Stock spacers	Rubber
1301 Tactical OD Green	12	76	47,5	Ghost Ring	OCHP or FX (CL/*****)	Stock spacers	Rubber
1301 Tactical Inox / Marine	12	76	47,5	Ghost Ring	OCHP or FX (CL/*****)	Stock spacers	Rubber



ARX 100



ARX 160



The ARX platform takes the concept of a modular rifle to futuristic levels, while maintaining an absolutely simple operation that make it ultra-reliable. With ambidextrous controls, easily-replaceable barrel and virtually endless possibilities for customization and accessorizing, the ARX100 is adaptable to any firing scenario and is perfect for today's most demanding tactical shooter. The ARX160 is a .22 LR tactical training rifle that looks, feels and handles like its full-size counterpart.

Model	Gauge	Action	Additional Magazines	Magazine Capacity (rounds)	Weight Unloaded (g)	Total Length (mm)	Barrel Length (mm)	Width (mm)	Height (mm)	Safety Position
ARX 100	.223 Rem	-	1	29	3084	673	16"	70	216	Receiver
ARX 160	.22 L.R.	S	1	5	3000	624	380	80	290	Receiver
ARX 160 with pistol stock	.22 L.R.	S	1	5	1700	480	211	80	290	Receiver



BERETTA CHOKES CONSTRUCTION CHART

AVERAGE % OF PELLETS AND CHOKE CONSTRUCTION BASED ON DISTANCE

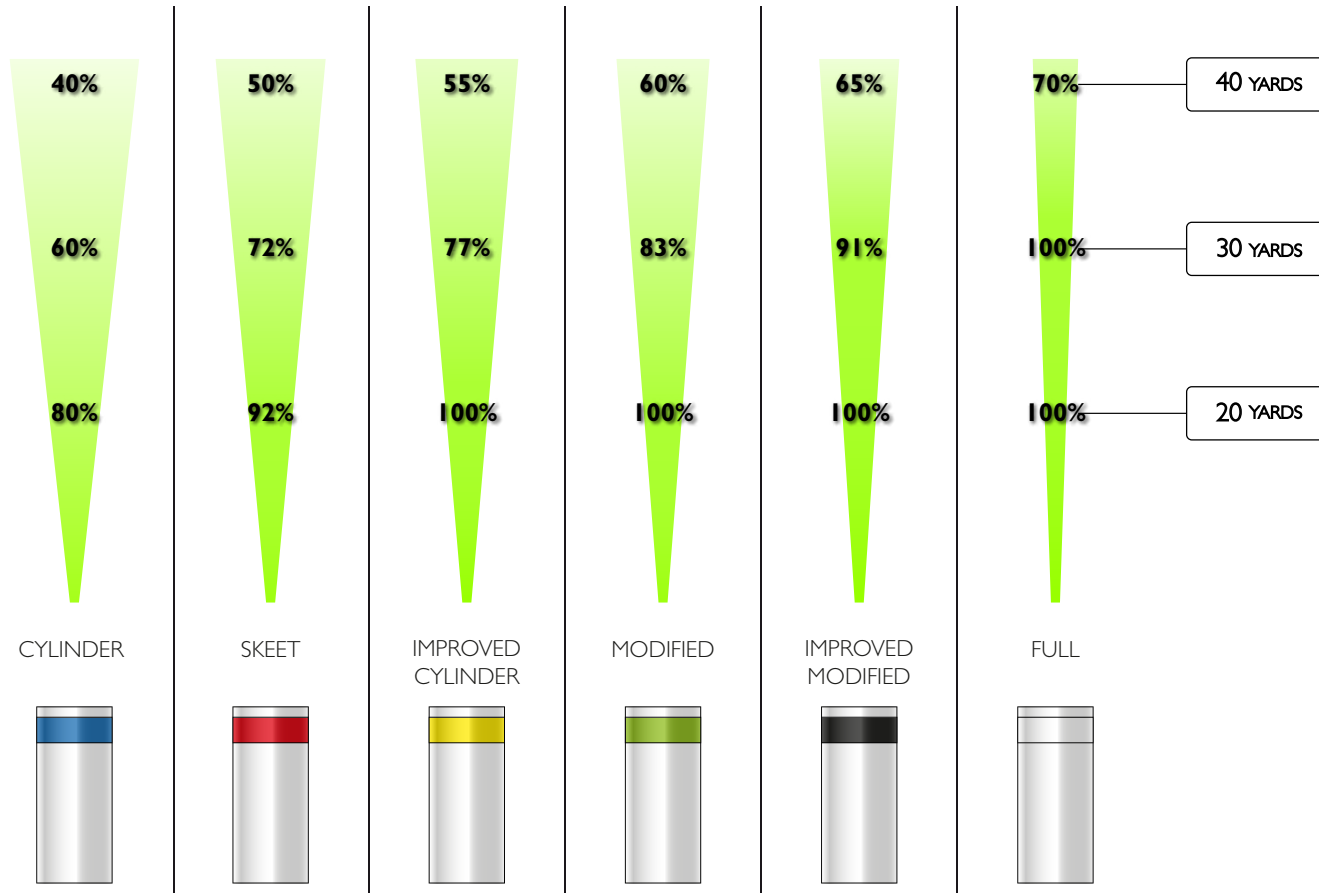

PERFECT BALLISTICS

With a production begun in 1526, now accounting for more than 500.000 barrels a year, Beretta is a world leader in technological research applied to ballistics. The Optimabore HP technology, combined with Steelium, provides excellent accuracy and pattern quality with both lead and Steel HP shots.



36% FASTER AND CLEANER

Blink is the engine of every A400 shotgun, providing exceptional reloading speed combined with power and cleanness at the top of the category. Being the fastest to fire the next shot means increasing the chance of hitting the target.



SOFTER & LIGHTER THAN RUBBER

Microcore is an innovative recoil pad developed by Beretta thanks to its experience in decades of competitions around the world. Thanks to the open cell technopolymer - softer, lighter and more slippery than rubber - Microcore expands gradually and instantly, increasing its surface area on the shoulder and giving the shotgun secure and precise support.



YOUR DIGITAL HUNTING DIARY, INTUITIVE AND EASY TO USE

Stop wondering how many rounds you shot last month or how many miles you walked with your dog: GunPod 2 will hold these statistics for you! The highlights of your hunting sessions, along with photos and videos, finally collected in a handy digital archive. And if you want to share on social networks? With GunPod 2 you can.



100% PROTECTION FROM CORROSION

In models equipped with AQUA technologies, all the internal parts are protected against rust and corrosion, while bolt, carrier and trigger are antireflective-treated. The barrel is internally chromed and externally coated to offer the best protection even in the worst conditions.



FAST LOCKING

B-Lok allows secure and fast forend's cap closing in fractions of a second and with just a 60 degrees rotation. The design of the cap makes the handling easy even with gloves on.



WORLD'S BEST RECOIL AND MUZZLE RAISE REDUCTION

Kick-Off is the only recoil reduction system in the world using technologies similar to the automotive ones, to provide up to 70% shock absorption. In its PLUS and MEGA versions, the Kick-Off system provides even more benefits, specifically tailored on the needs particular types of hunting.



Steelium Technology Evolution.

STEELIUM PRO



CONICAL PART



STEELIUM PLUS



CONICAL PART



STEELIUM



CONICAL PART



STEELIUM - THE ULTIMATE BARRELL TECHNOLOGY.

The ingredients of the stunning accuracy of the Beretta Steelium Plus barrels are: the exclusive tri-alloy Beretta Steel (Ni, Cr, Mo), the deep drilling, the cold hammering forging process, the vacuum distension and the extended forcing cone, 5,5 times longer than in standard barrels. Every OptimaBore HP barrel profile has been specifically designed and tested to provide perfect accuracy with every type of shells: lead, steel and steel High Performance.

This results in perfect patterns on every shot.

At the beginning of the Steelium era, all the barrels had a similar profile with the forcing cone length of 65 mm (on a 76 cm barrel).

Steelium Plus defined a new standard, lengthening the conical part to 360 mm (on a 76 cm barrel).

Steelium Pro barrel furtherly improved the inner profile of the forcing cone extending it to 480 mm (on a 76 cm barrel).

This important and progressive evolution provides smoother shot with reduced muzzle rise and consistent patterns with every type of shell.

TRI-ALLOY STEEL



DEEP DRILLING



COLD HAMMER FORGING



VACUUM DISTENSION





BERETTA GALLERY

LONDON

36 St. James's Street
London, SW1A 1JD, U.K.
Tel. +44 207 408 4411

PARIS

57, Rue Pierre Charron
75008 Paris, France
Tel. +33 1 56 88 59 59

MADRID

Beretta at EL CORTE INGLÉS
Raimundo Fernández de Villaverde, 79
28003 Madrid, España
Tel. +34 914 18 88 00

NEW YORK

718 Madison Avenue
New York, NY 10065, U.S.A.
Tel. +1 212 319 3235

MEMPHIS

Beretta at BASS PRO SHOPS
1 Bass Pro Drive
Memphis Pyramid, TN 38105, U.S.A.
Tel. 901-291-8200

Beretta at HARRODS

87-135 Brompton Road
London, SW1X 7XL, U.K.
Tel. +44 207 730 1234
ext. 2092

MILANO

Beretta at RAVIZZA
Via Hoepli, 3
20122 Milano, Italia
Tel. + 39 02 7602 8325

MOSCOW

Beretta at KOLCHUGA
Varvarka str. 3,
109012, Moscow, Russia
Tel. +8 495 234 34 43

DALLAS

41 Highland Park Village
Dallas, TX 75205, U.S.A.
Tel. +1 214 559 9800

BUENOS AIRES

Arenales 1654/56
1061 Capital Federal
Buenos Aires, Argentina
Tel. +54 114 8139 258