

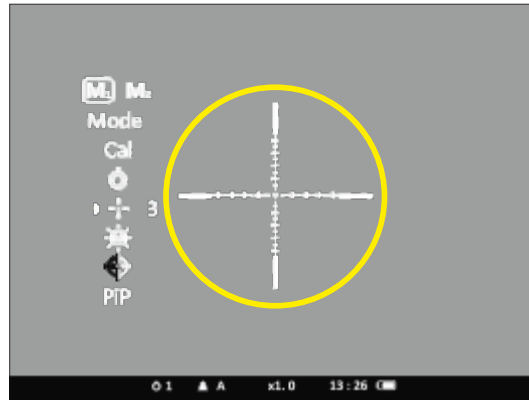

**APEX XD75 / LD75 THERMAL SIGHTS
RETICLE CATALOGUE**

NOTICE:

1. Reticles' configuration indicated in the pictures imitating the image from the rifle scope can differ from the real one and is provided for the evaluation of size and position of the reticle in the field of view.



2. The values of the reticles indicated in this catalogue are correct in the following cases:

- when the magnification of the scope is set to minimum



- when "picture in picture" is activated



RETICLE NAME: H50

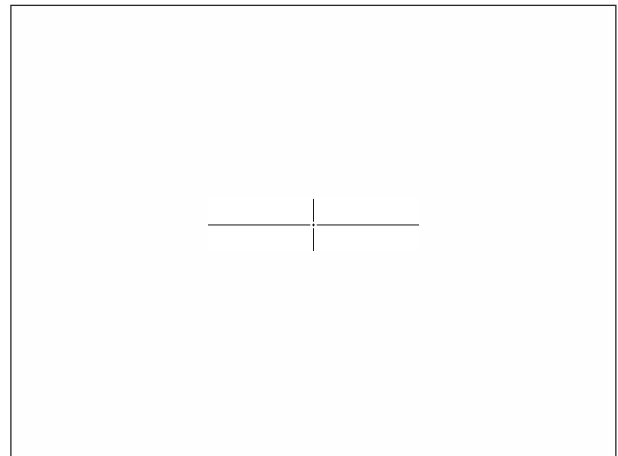
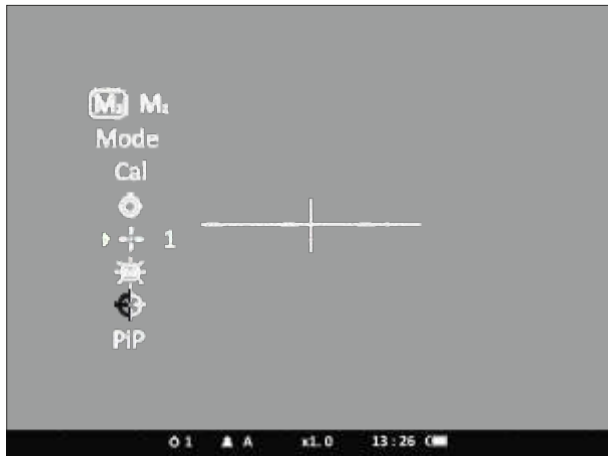

Reticle parameters in **Pixels / cm @ 100 m / MOA**:

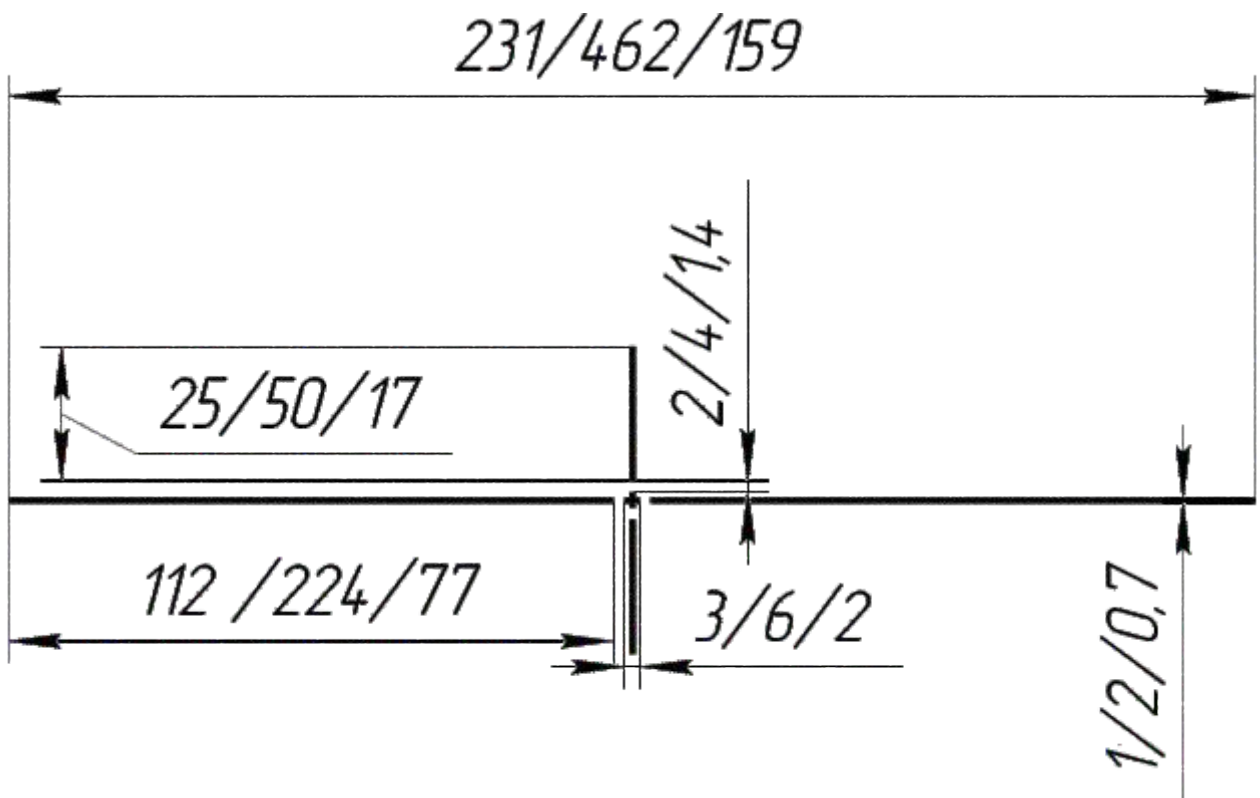

RETICLE NAME: M50

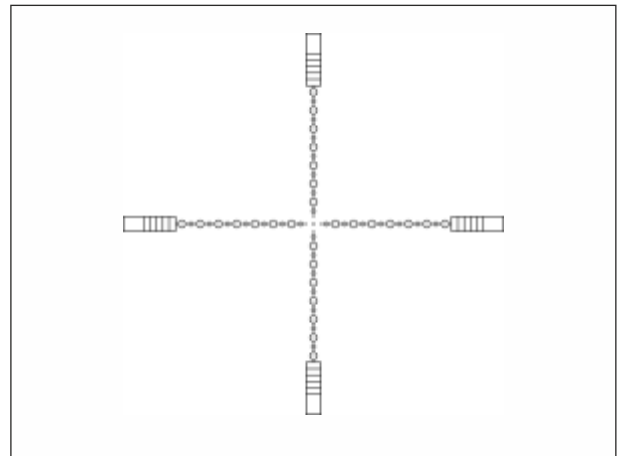
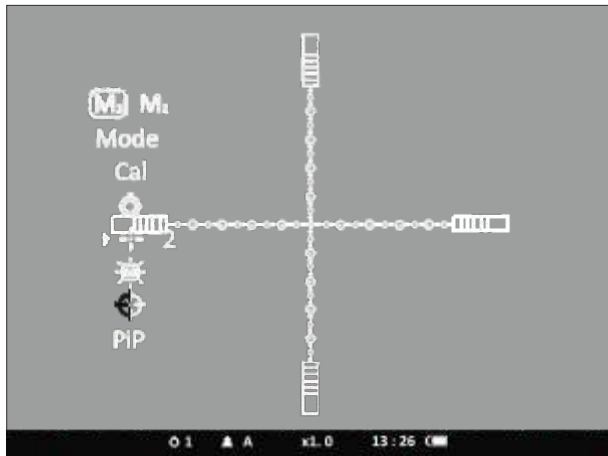

Reticle parameters in Pixels / cm @ 100 m / MOA:

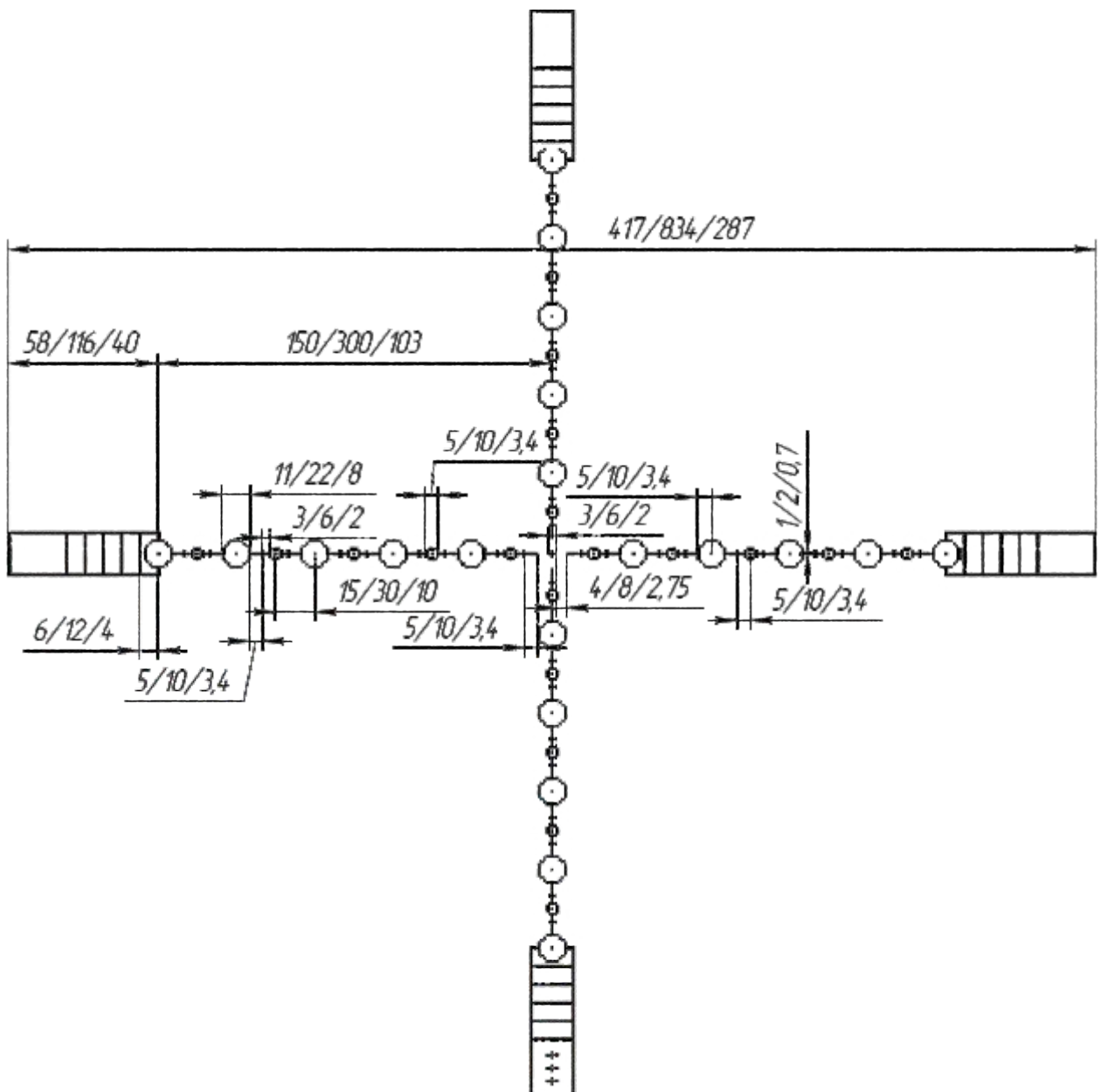

RETICLE NAME: **M52**

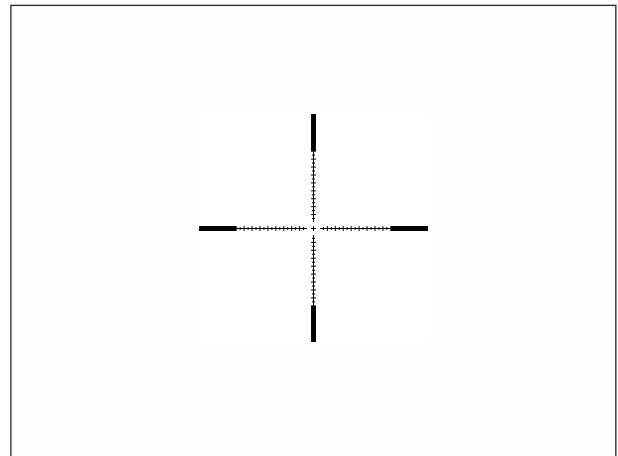
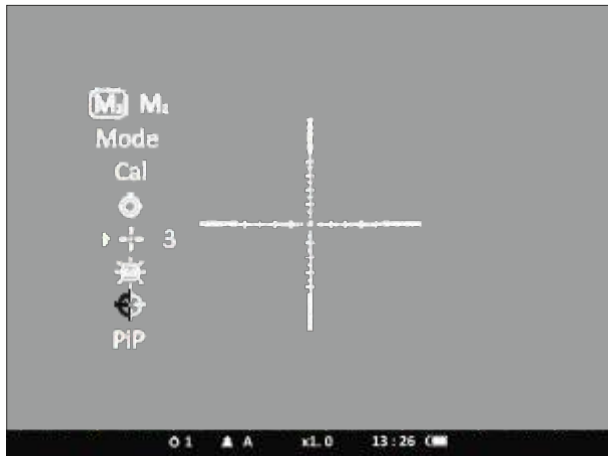

Reticle parameters in **Pixels / cm @ 100 m / MOA:**

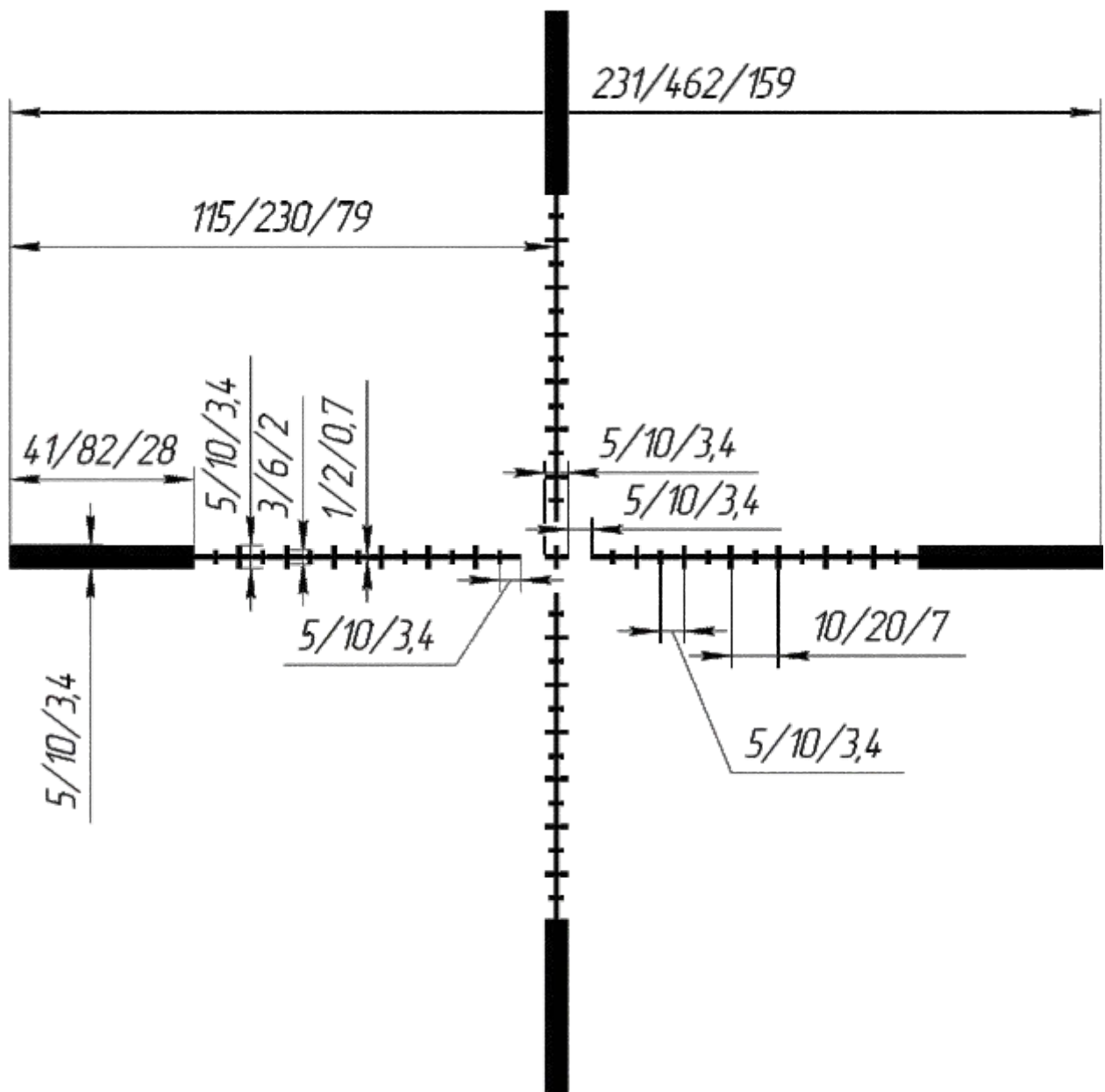

RETICLE NAME: **M54**

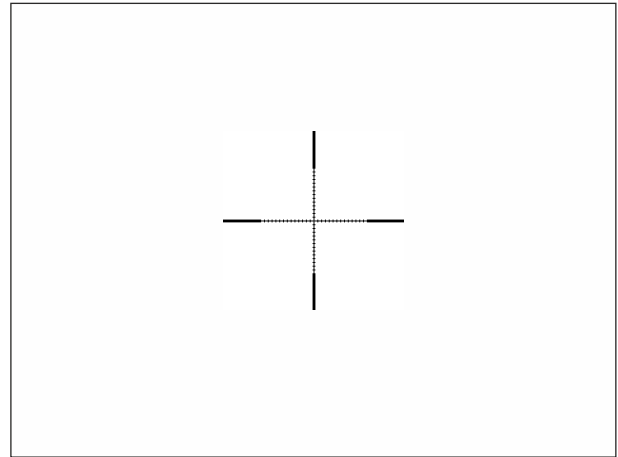
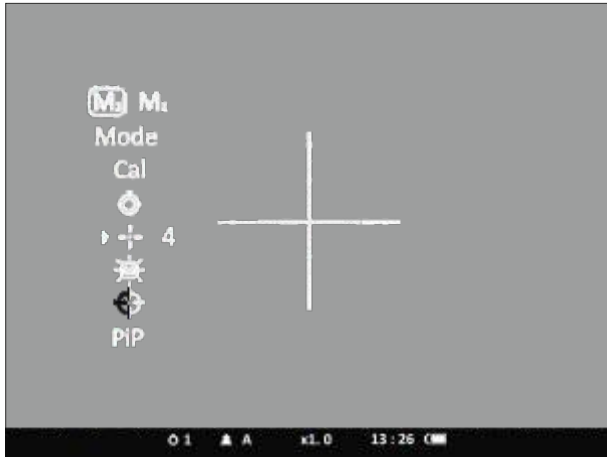

Reticle parameters in **Pixels / cm @ 100 m / MOA**:

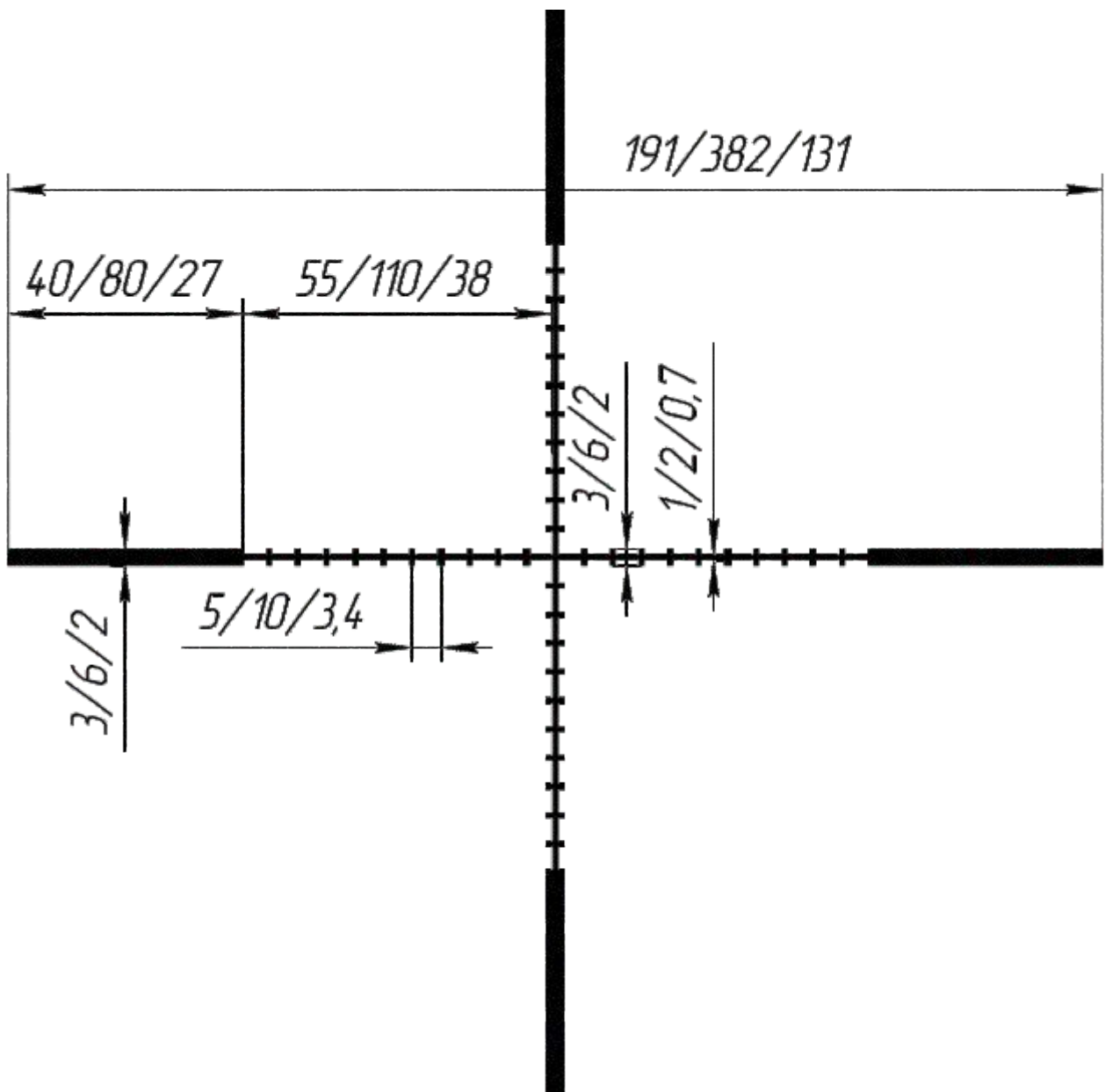

RETICLE NAME: X53

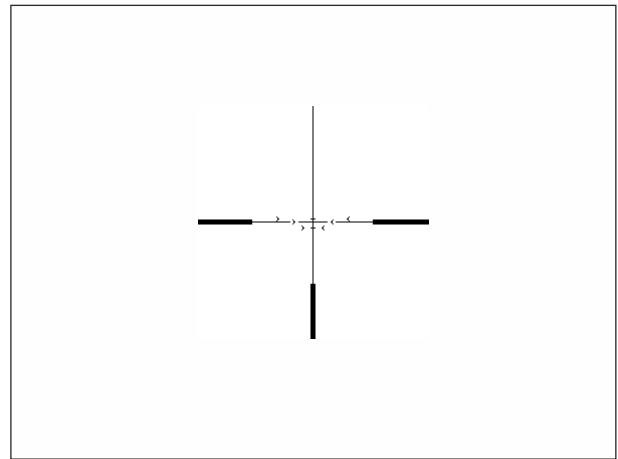
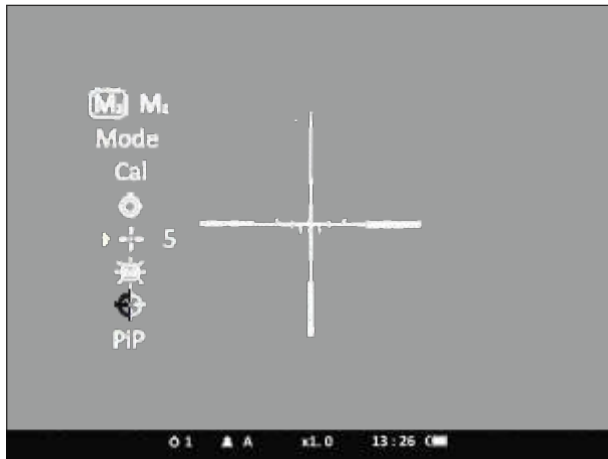

Reticle parameters in Pixels / cm @ 100 m / MOA:

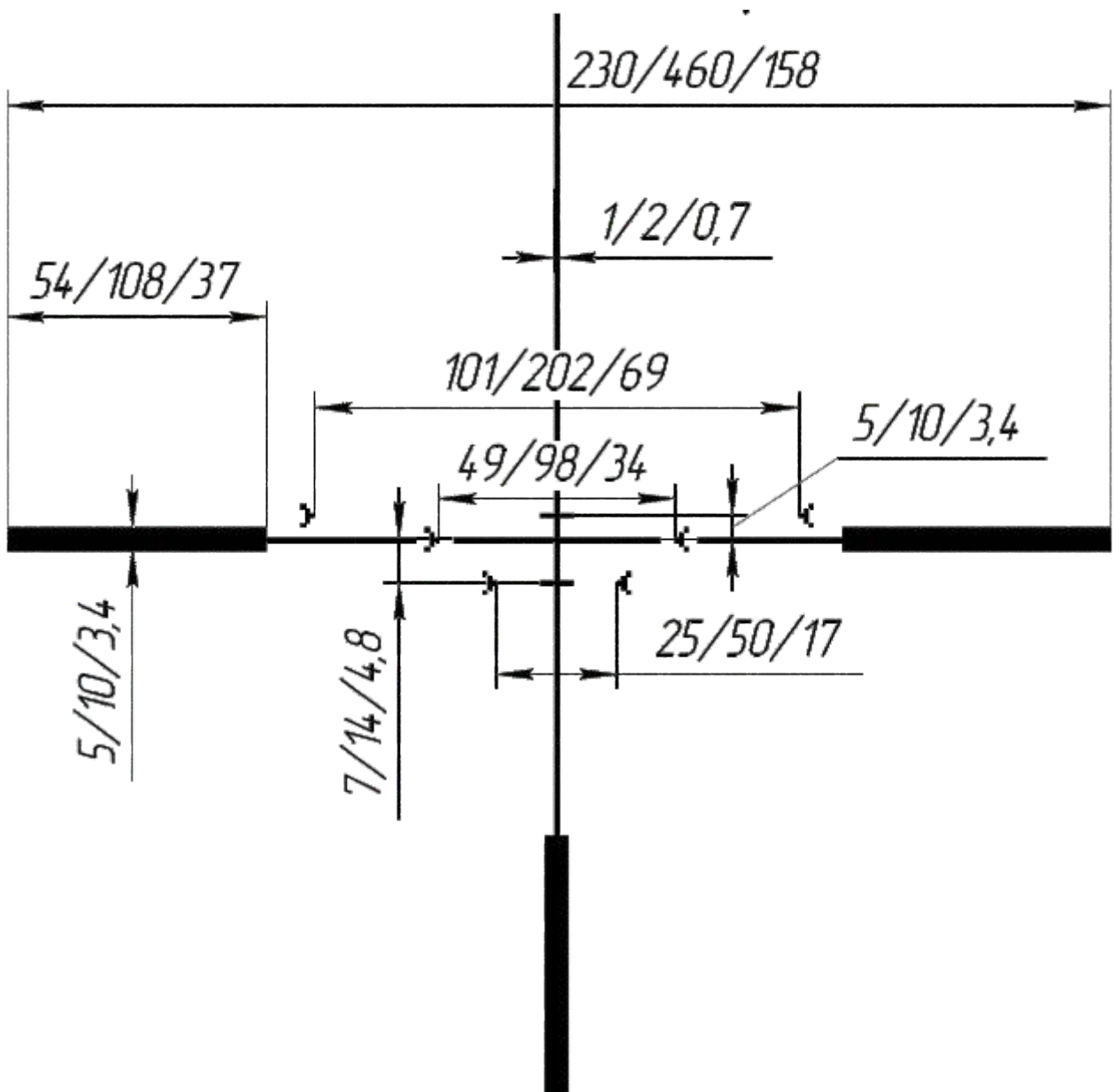

RETICLE NAME: T50

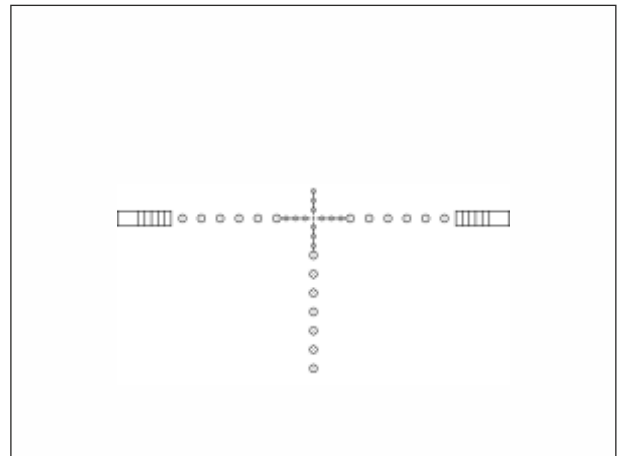
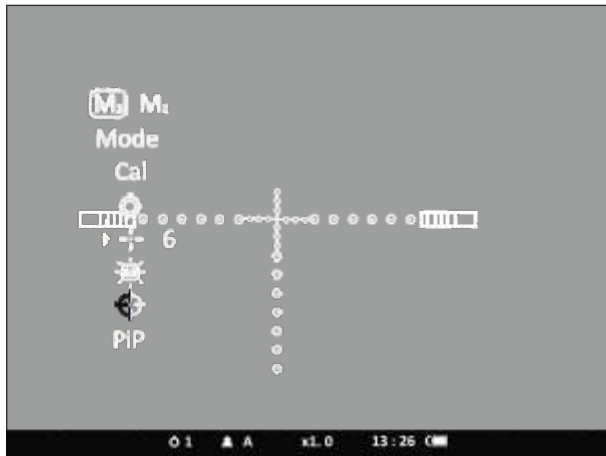

Reticle parameters in Pixels / cm @ 100 m / MOA:

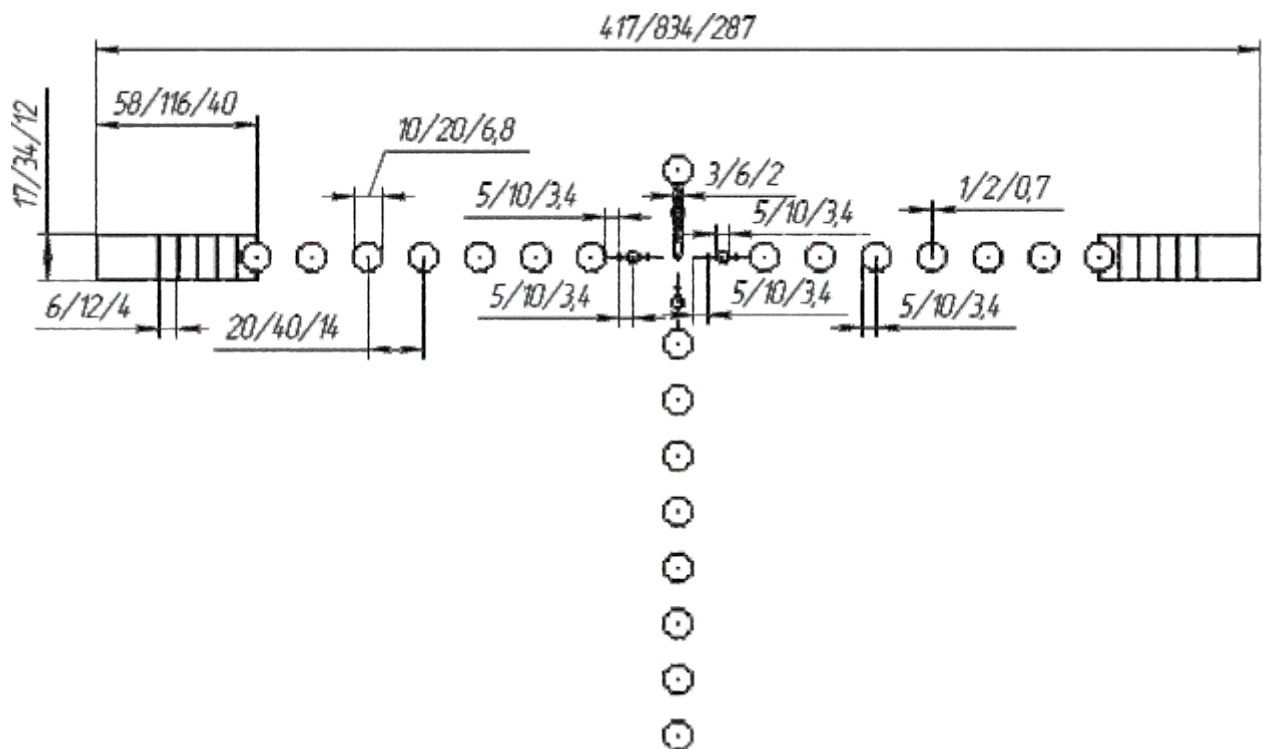

RETICLE NAME: T51

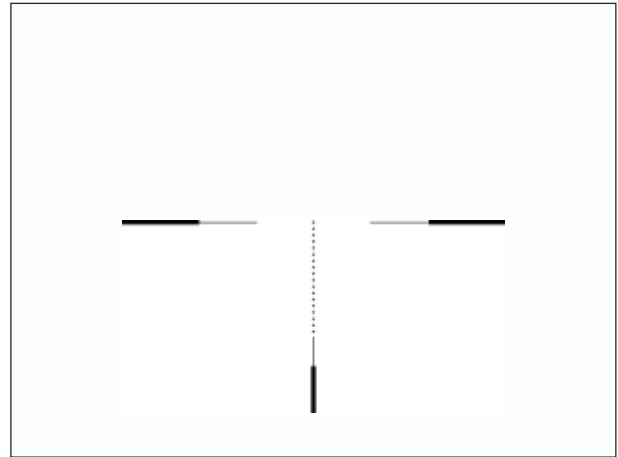
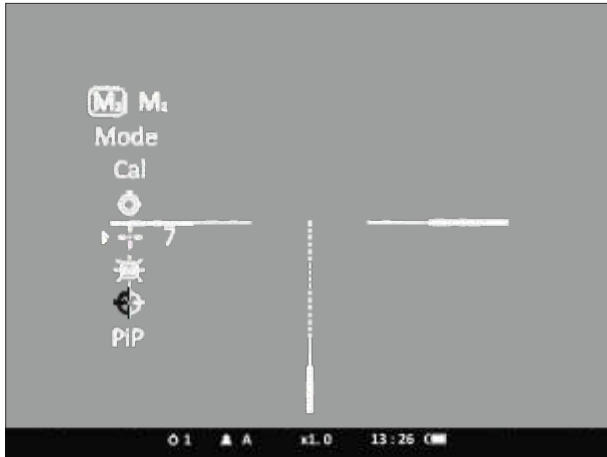

Reticle parameters in Pixels / cm @ 100 m / MOA:

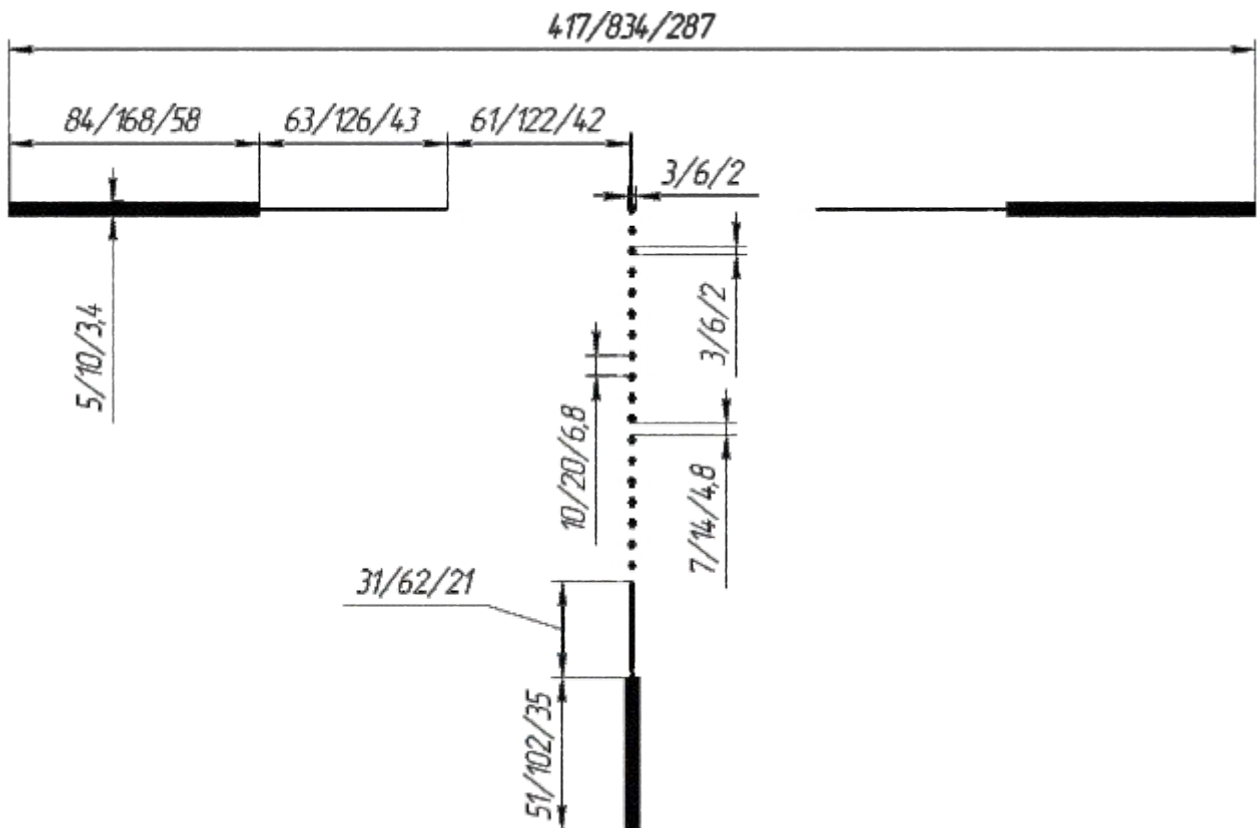

RETICLE NAME: T52

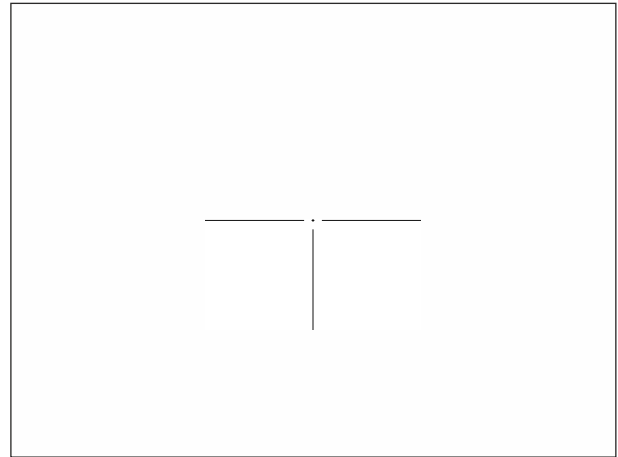
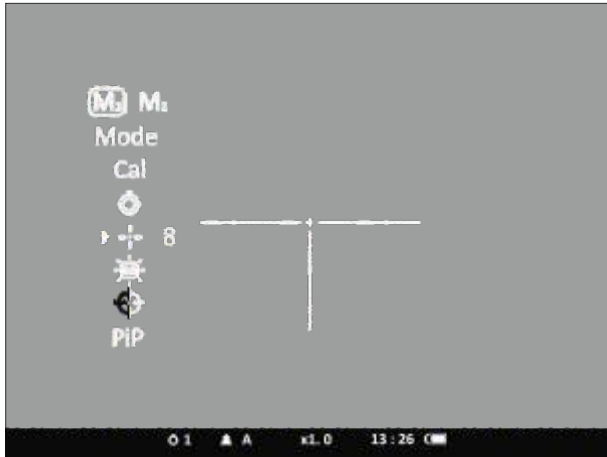

Reticle parameters in **Pixels / cm @ 100 m / MOA**:

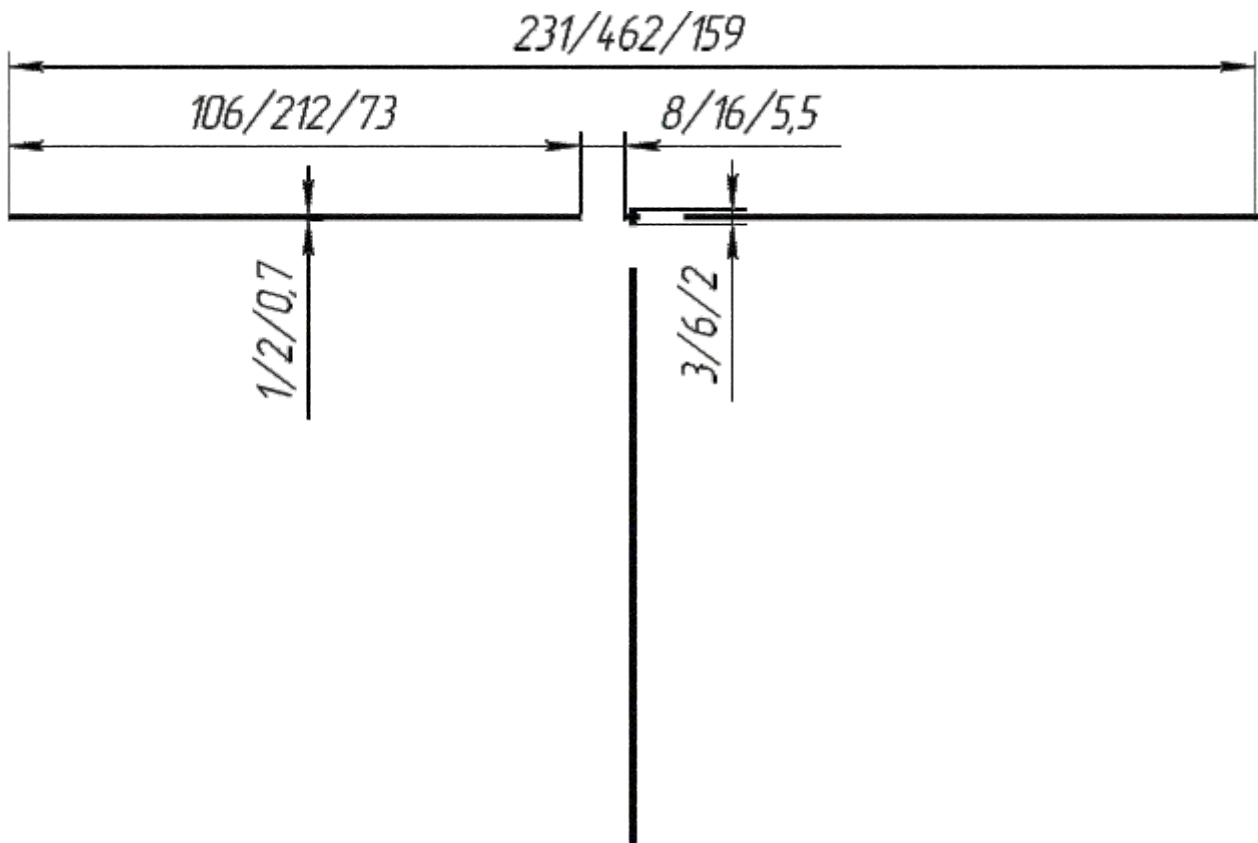

RETICLE NAME: X51

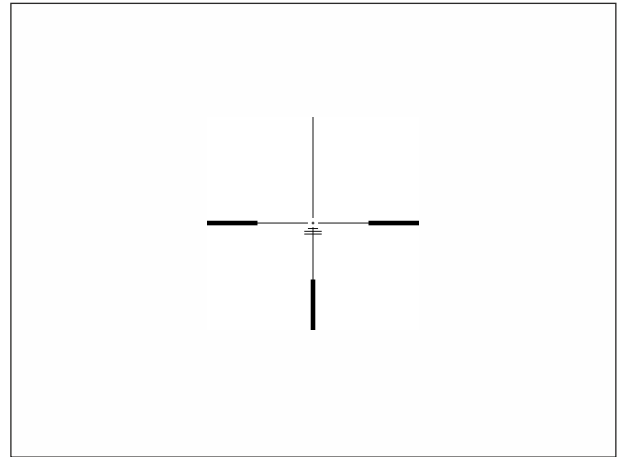
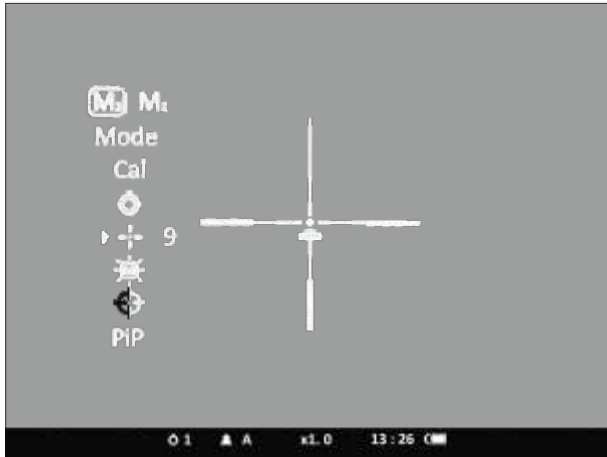

Reticle parameters in Pixels / cm @ 100 m / MOA:

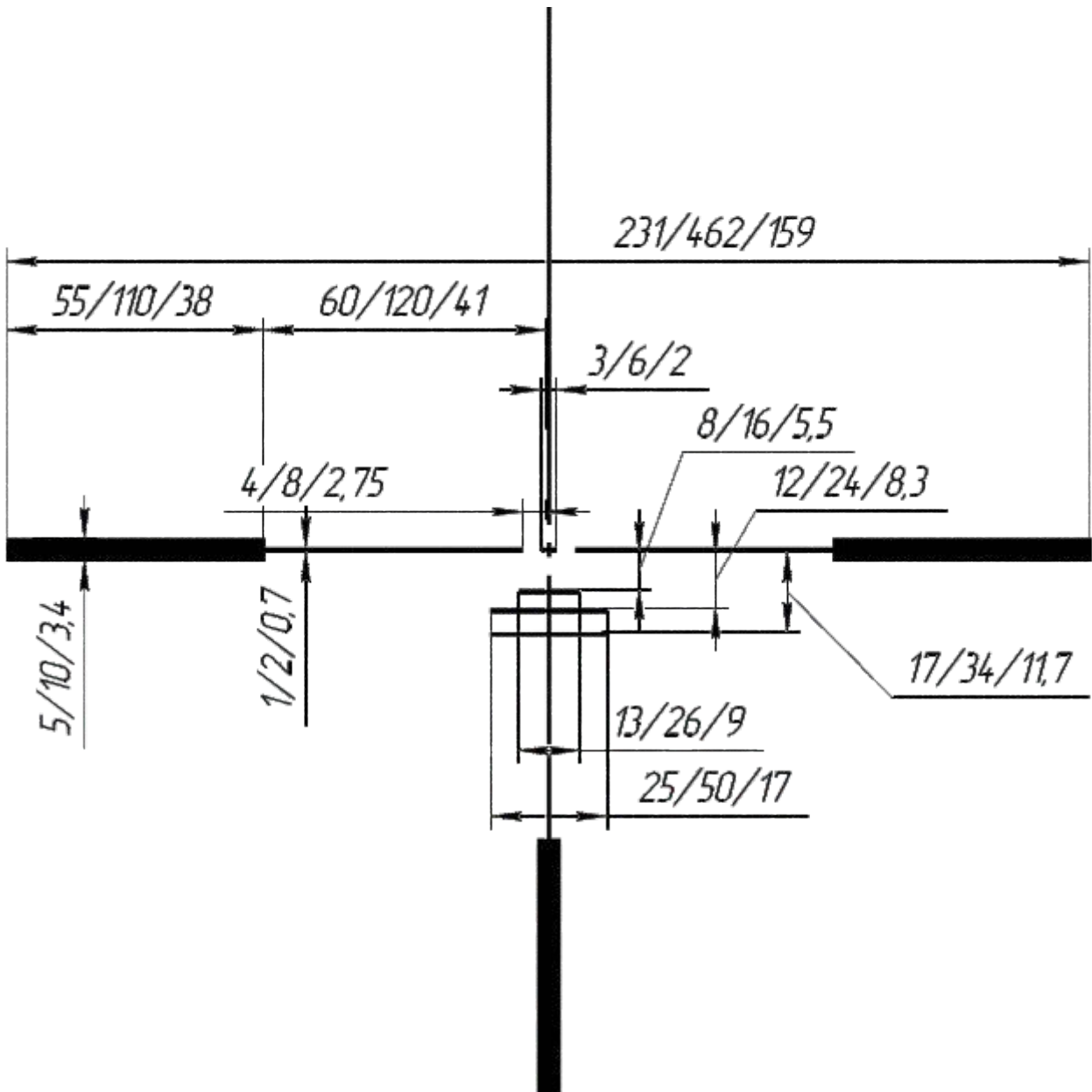

RETICLE NAME: X54

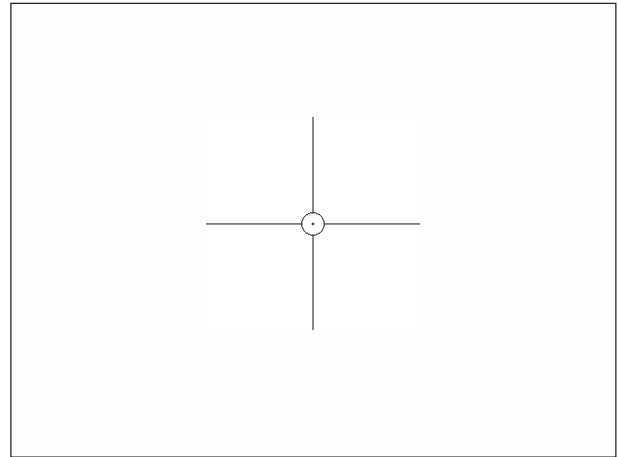
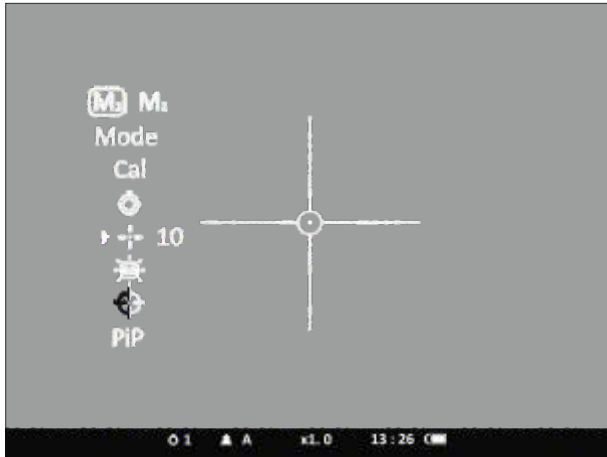

Reticle parameters in Pixels / cm @ 100 m / MOA:

