

Kimber®

2018





MADE IN AMERICA

UNEQUALED QUALITY.

EVEN BEFORE THE FIRST KIMBER® rifle was completed some 39 years ago, manufacturing firearms of unequalled quality was already Kimber's singular goal. Do this, it was reasoned, and everything else will fall in line. On the strength of that commitment, Kimber has become the world's largest producer of 1911 pistols and the market leader in classic hunting rifles. Recent introductions of dynamic platforms like the Micro 9 and K6s handguns,



WHAT ALL GUNS SHOULD BE™

along with PepperBlaster® less-lethal products, have established Kimber® as an innovator as well; a position that will continue to solidify as new firearms and accessories are launched. Quality is the true measure of value. Whether it means accuracy or dependability, the beauty of a finish or the precise fit of wood to metal, quality is an integral part of every Kimber.

kimberamerica.com

Kimber

NEW PRODUCTS

KIMBER'S EVER-EVOLVING QUEST to build premier U.S. manufactured firearms drives us to apply our signature quality, performance and reliability into new lines of handguns and rifles, along with the expansion of existing platforms. From concealed

carry and personal defense to target shooting and game hunting, our constant pursuit of perfection pushes us—being the best is not good enough. That is why Kimber is What All Guns Should Be™.

MICRO & MICRO 9

2018 BRINGS SOME of our most popular family stylings to our Micro and Micro 9 models. The Micro and Micro 9 TLE wear black and grips in the same colorway as their 1911 cousins. The Micro and Micro 9 Coverts are finished in KimPro® II gray with urban camo Crimson Trace Lasergrips. Eclipse fit and finish now has a home in the Micro and Micro 9 platform, and 5 new models carrying Hogue® Wrap Around Grips and TRUGLO® TFX™ Pro Day/Night sights have joined the platform.



MICRO TLE

See page 35



MICRO 9 COVERT

See page 39



HERO CUSTOM

See page 26



AEGIS ELITE CUSTOM (01)

See page 23

AEGIS ELITE

FOUNDED ON THE idea that custom work does not have to take custom time, Kimber again takes what would be a long process and brings it to a dealer near you—mini red dot sight (MRDS) mounted 1911s.

HERO CUSTOM

THE BOOT CAMPAIGN stands for serving those who have given so much for our country, and we couldn't be more proud to stand with them on this special edition 1911. We could not find a more fitting name for this model than Hero.

HANDGUN SELECTION GUIDE	6
1911 PISTOLS	8
TWO-TONE II	10
STAINLESS™ II	11
TLE™ II	12
ECLIPSE™	14
WARRIOR®	15
CDP™	16
SUPER CARRY™	17
CRIMSON CARRY™ II	18

RAPTOR™ II	19
MASTER CARRY™	20
COVERT™	21
KHX	22
AEGIS ELITE	23
GOLD MATCH™ II	24
RIMFIRE CONVERSION KITS	25
SPECIAL EDITIONS	26
CUSTOM SHOP	28
MICRO PISTOLS	32



MADE IN AMERICA



KHX CUSTOM

See page 22



KHX PRO (OR)

See page 22

KHX

KHX MODELS SET a new standard for today's 1911. Hexagonal stair-stepped serrations for a positive grip surface no matter the conditions, bright fiber optics and Hogue's Enhanced MagGrip G10 grips give you all the advantages asked for but in an innovative format. The Optics Ready (OR) models come pre-milled for plates that mount a variety of red dot sights to create your ideal MRDS 1911.



K6s STAINLESS 3"

See page 46

K6s ADDITIONS

THE WILDLY POPULAR K6s revolver family has gotten three new editions: K6s CDP; K6s DC; and K6s Stainless 3". After hearing our customers call for a longer barreled version, we're happy to introduce this model in our 2018 lineup.

HUNTER, OPEN COUNTRY, ADVANCED TACTICAL SOC II

Expanding our popular Hunter platform to include two new patterns, a low-visibility black barrel and action, and a limited Boot Campaign edition, our Hunter rifle will truly have a model for every hunter. Our Advanced Tactical SOC II is updated with a McCree stock in Sniper Gray and FDE, built for Law Enforcement and long-range precision competitors. Open Country expands to the .308 Win. and the new Granite stock with KimPro® II black barrel and action.



See page 54



See page 62



See page 66

MICRO™	34
MICRO 9™	38
K6s® REVOLVERS	44
RIFLES	48
RIFLE SELECTION GUIDE	50
TRADITIONAL	52
HUNTER	54
MOUNTAIN	56
DANGEROUS GAME	60
OPEN RANGE	62

VARMINT	64
TACTICAL	66
OPTICS	70
LESS LETHAL	72
ACCESSORIES	73
SPECIFICATIONS	
PISTOLS	74
MICRO	76
REVOLVER	76
RIFLES	77





TRUST IS NOT GIVEN LIGHTLY.
IT'S EARNED IN THE FIELD.



HANDGUN SELECTION GUIDE

MICRO™ .380 ACP pistols include many proven 1911 design elements that make them comfortable to carry, quick and safe to operate, and easy to shoot accurately. With a starting weight of 13.4 ounces and barrel length of 2.75 inches, they are well-suited for concealed carry. Mild .380 ACP recoil, smooth single-action trigger pull and well-designed sights make them a pleasure to shoot. They are also a perfect fit for any size hand.

- Short 2.75-inch barrel and thin profile ensures concealability
- With a starting weight of 13.4 ounces, Micro pistols are easy to carry
- Smaller grip dimensions provide a good fit for all hand sizes



MICRO 9™ pistols bring the 9mm caliber to our popular Micro family. Continuing with the concealable size and comfortable ergonomics of the Micro pistols, the Micro 9 pistols are equally safe and easy to shoot accurately. Only a small step up in size, they have a starting weight of 15.6 ounces and a barrel length of 3.15 inches. Manageable 9mm recoil, a smooth single-action trigger pull, available in a variety of finishes and sights, there is a Micro 9 for every shooter.

- Short 3.15-inch barrel and thin profile ensures concealability
- With a starting weight of 15.6 ounces, Micro 9 pistols are easy to carry
- Smaller grip dimensions provide a good fit for all hand sizes



ULTRA+™ models combine the 3-inch barrel and light weight of Ultra models with a full-length grip for improved recoil control. They are a better fit for shooters with large hands and accept full-length magazines with additional capacity. Weighing just 27 ounces (2 ounces more than an Ultra) the increased control provided by the full-length grip is a significant advantage for many shooters, improving accuracy and reducing time between shots.

- Barrel is just 3 inches long for easy concealment
- Full-length grip fits shooters with larger hands
- Weighing just 27 ounces, Ultra+ pistols are easy to carry
- Available in .45 ACP



PRO™ models may be the best all-around 1911 configuration, combining a 4-inch barrel with a full-length grip. It is certain to be an ideal choice for concealed carry, personal defense or general use. Some have lightweight aluminum frames while others have heavier steel frames, and two models include the Kimber Tactical Rail™ for mounting lights and accessories. All have a near-perfect balance that makes shooting them easy, accurate and fun.

- Barrel is 4 inches long to optimize balance and concealability
- Full-length grip fits shooters with larger hands
- Frame options permit a model selection that meets multiple needs
- Available in 2 calibers



SUGGESTED USE ICONS

Below and on the following pages you will find a suggested use based on the size and features of each gun. This icon does not necessarily mean a certain firearm is not suitable for other uses. Visit our website or call our customer service staff for questions.



CARRY

The features and size of these firearms are well-suited for personal defense situations.



HOME DEFENSE

The features and size of these firearms are well-suited for in-home defense.



MULTIPLE USE

These firearms are suitable for use in a variety of spaces, in and outside of the home.



TARGET

Topped with adjustable sights, these 1911s are well-suited for competition or a day at the range.



LE

The features on these firearms make them an excellent choice for duty carry.



HUNT

These models are well-suited for backcountry camp protection and handgun hunting.

K6s[®] models have a 6-round capacity, compact frame and cylinder, and a 2- or 3-inch barrel. There is an internal hammer, and edges are rounded and blended so they are less likely to hang up on clothing. For those that require power in a small package with mild recoil, the K6s fits the bill as it is designed to handle both .357 Magnum and .38 Special +P ammunition. This makes them well-suited for backup or concealed carry.

- Compact 6-round capacity cylinder
- 2- or 3-inch barrel
- Ergonomic grip design for easy recoil control
- Available .357 Magnum/.38 Special

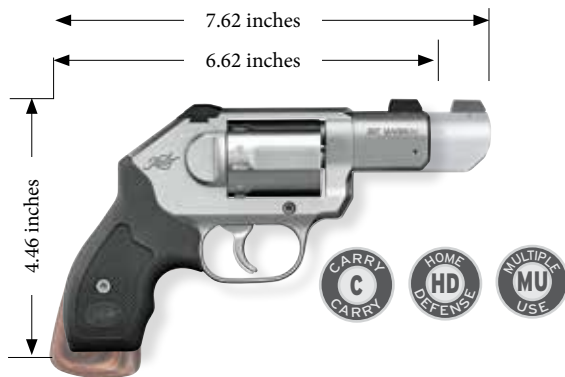

ULTRA[™] models are easy to conceal and comfortable to carry with their 3-inch bull barrels and short grips. Most frames are made from aluminum rather than steel to reduce weight. While light pistols do have a slight increase in felt recoil, this is minimized by Kimber's recoil system and unequaled 1911 ergonomics. Ultra pistols are the smallest and lightest 1911 pistols offered today, but Kimber quality helps ensure this does not compromise either dependability or accuracy.

- Barrel is just 3 inches long for easy concealment
- Short grip for concealability and comfortable carry
- Most Ultra models weigh just 25 ounces
- Available in 2 calibers



CUSTOM[™] models are full-size 1911 pistols featuring a 5-inch barrel and full-length grip. The most popular configuration, they are favored by law enforcement professionals and competition shooters. Slightly heavier and with a greater distance between sights, they are easier to shoot accurately and have reduced felt recoil. The slim profile and outstanding 1911 ergonomics make them well-suited for duty, personal defense and general use.

- Full-length grip fits shooters with larger hands
- Barrel is 5 inches long for optimal velocity and accuracy
- Wide selection of models for any application
- Available in 4 calibers



LS models are full-size 1911 pistols featuring a 6-inch barrel and full-length grip. An ideal configuration for competition or as a hunting side-arm, the Long Slide 1911s are a popular platform at the range and in the field because of their inherent accuracy and recoil reducing weight.

- Full-length grip fits shooters with larger hands
- Barrel is 6 inches long for optimal velocity and accuracy
- Porting, optics installed, adjustable sights, rounded heel frame are among features on these models
- Available in 2 calibers



Each of these pistols overlays the image of a custom-size 1911 for comparison.



MADE IN AMERICA



ACCURACY, DEPENDABILITY and meaningful features determine the true quality of a pistol. On the strength of quality, Kimber® has become the world's largest pro-

ducer of 1911 pistols. Compare a Kimber 1911 with any other brand—or any other type of semi-automatic—and see why Kimber is What All Guns Should Be™.

DETAILS AND CRAFTSMANSHIP OTHERS CONSIDER EXTRA WE CALL STANDARD ON EVERY KIMBER 1911:

Fixed or adjustable sights (depending on model) securely mounted in dovetails for maximum integrity

Commander-style hammer will not cut or snag

With a pull of 4-5 pounds, Kimber's match grade trigger breaks crisp and clean, increasing both confidence and accuracy

Beveled magazine well aids fast reloading by guiding the magazine into the frame

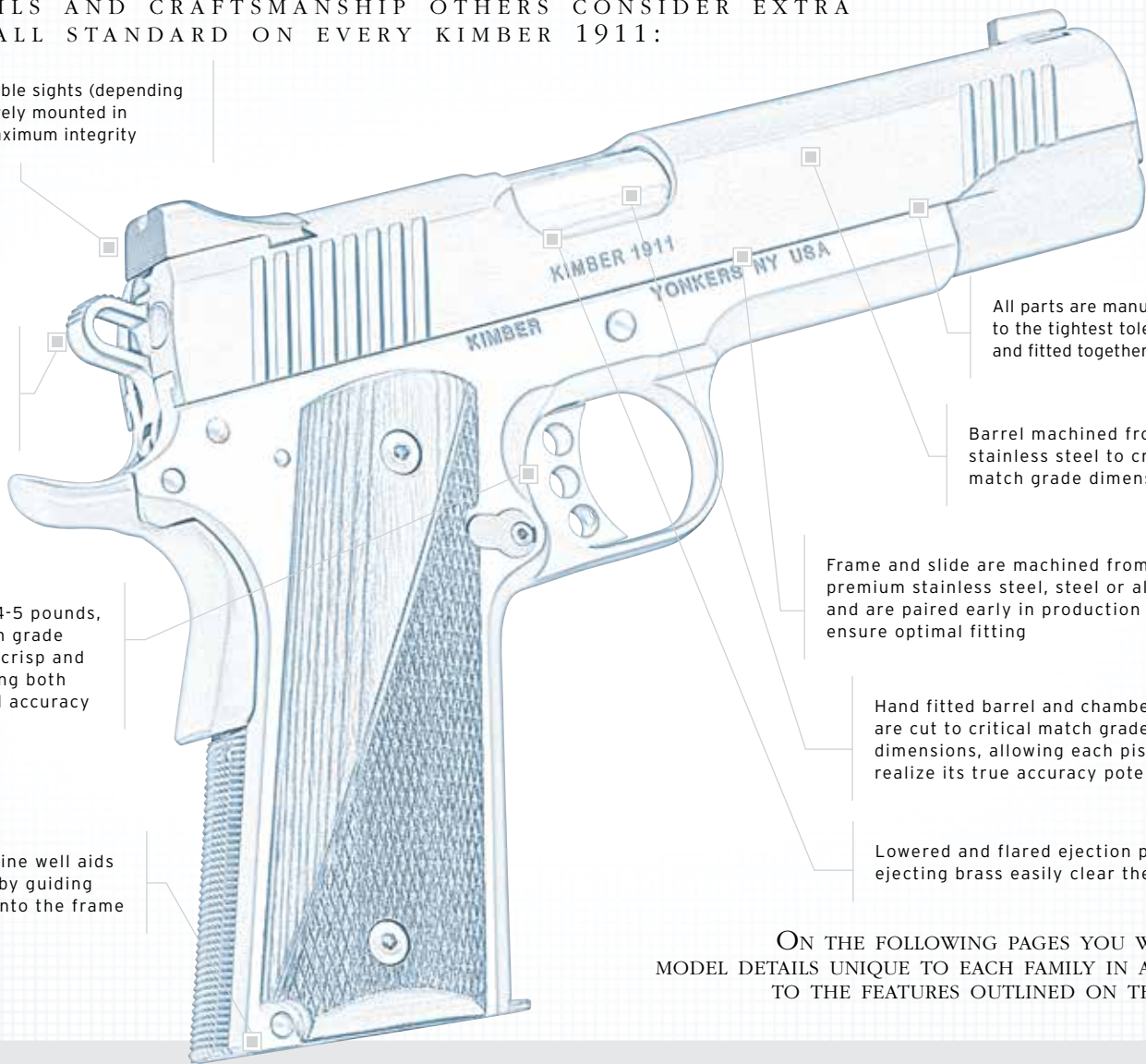

All parts are manufactured to the tightest tolerances and fitted together by hand

Barrel machined from solid stainless steel to critical match grade dimensions

Frame and slide are machined from premium stainless steel, steel or aluminum and are paired early in production to help ensure optimal fitting

Hand fitted barrel and chamber are cut to critical match grade dimensions, allowing each pistol to realize its true accuracy potential

Lowered and flared ejection port lets ejecting brass easily clear the slide

ON THE FOLLOWING PAGES YOU WILL FIND MODEL DETAILS UNIQUE TO EACH FAMILY IN ADDITION TO THE FEATURES OUTLINED ON THIS PAGE.

Kimber® builds the world's finest 1911 pistols to the tightest tolerances right here in America. Moreover, each critical component is manufactured inside the Kimber factories; getting it right means doing it yourself. The finest raw materials form the foundation and Kimber does the rest, ensuring every part meets unequal standards. America's best shooters, including legendary SWAT units and United States Marines assigned

to the U.S. Special Operations Command, have chosen Kimber for its quality, dependability and accuracy. So should you. Descriptions of each Kimber 1911 family of pistols are presented throughout the following pages. To locate your nearest Kimber Master Dealer or find complete descriptions of each model pictured in this catalog, visit kimberamerica.com.

1911 PISTOLS

MORE THAN A COLLECTION OF PARTS.
A STATEMENT OF PRINCIPLE.



Kimber

TWO-TONE II

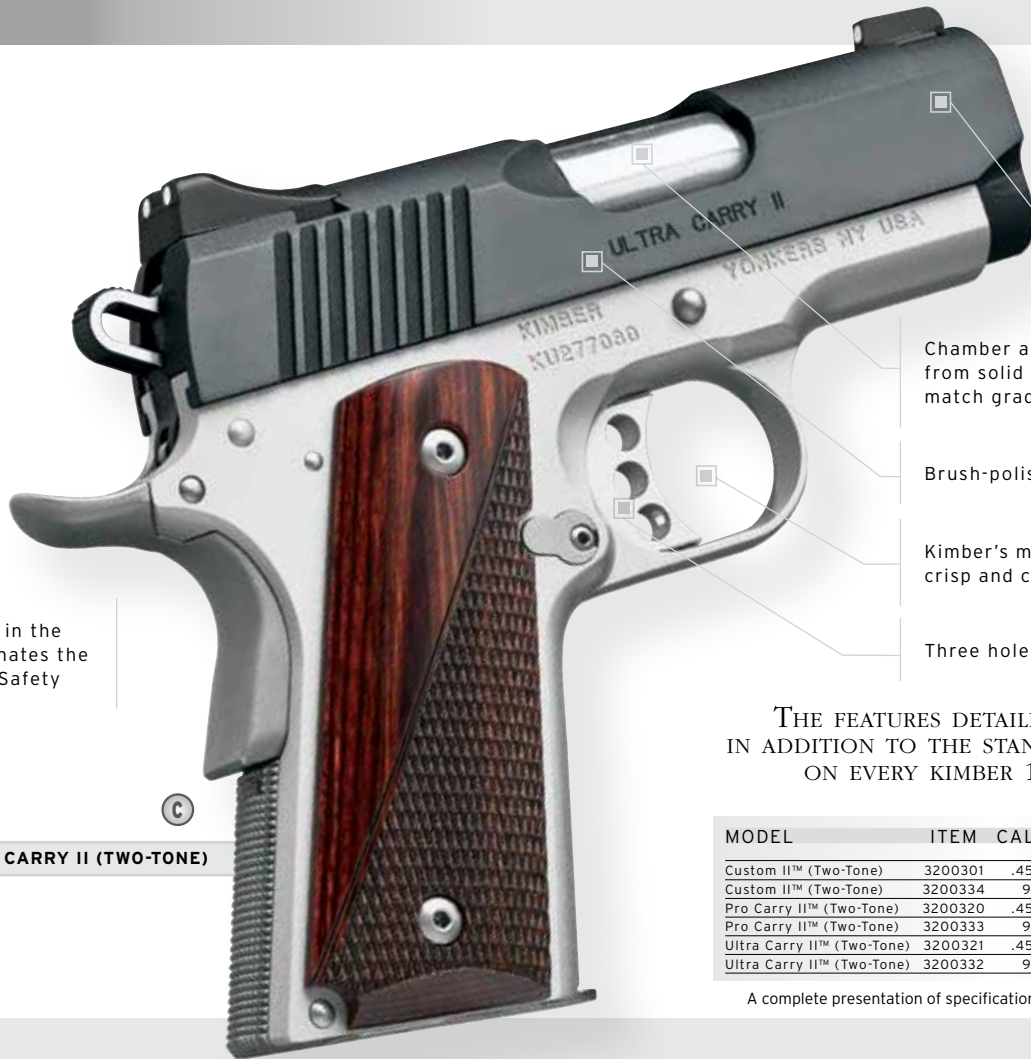

Please note: a "II" in the model name designates the Kimber Firing Pin Safety

Two-tone slide and frame finish

Chamber and barrel are machined from solid stainless steel to critical match grade dimensions

Brush-polished slide flats

Kimber's match grade trigger breaks crisp and clean at 4-5 pounds

Three hole trigger

ULTRA CARRY II (TWO-TONE)

THE FEATURES DETAILED ABOVE ARE OFFERED IN ADDITION TO THE STANDARD FEATURES FOUND ON EVERY KIMBER 1911 LISTED ON PAGE 8.

MODEL	ITEM	CALIBER	BARREL (Inches)	WEIGHT (Ounces)
Custom II™ (Two-Tone)	3200301	.45 ACP	5	38
Custom II™ (Two-Tone)	3200334	9mm	5	38
Pro Carry II™ (Two-Tone)	3200320	.45 ACP	4	28
Pro Carry II™ (Two-Tone)	3200333	9mm	4	28
Ultra Carry II™ (Two-Tone)	3200321	.45 ACP	3	25
Ultra Carry II™ (Two-Tone)	3200332	9mm	3	25

A complete presentation of specifications and features begins on page 74.

GETTING BACK TO BASICS has never looked so good. The Kimber Two-Tone family has no-nonsense features that promote intuitive operation and dependability, including lowered and flared ejection ports, machined dovetail mounted sights and edges that are rounded and blended for comfortable

carry. The classic two-tone slide and frame finish is accented by rosewood grips. Offering two caliber options in all three sizes, this Kimber 1911 is a perfect choice for concealed carry or personal defense.



ULTRA CARRY II (TWO-TONE)



PRO CARRY II (TWO-TONE)

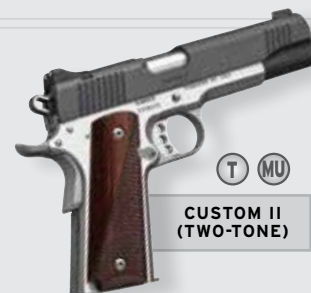

CUSTOM II (TWO-TONE)

STAINLESS II



Rosewood grips feature the Kimber logo

Fiber optic sight for faster sight acquisition

6-inch barrel for increased inherent accuracy

Chamber and barrel are machined from solid stainless steel to critical match grade dimensions

Kimber's match grade trigger breaks crisp and clean at 4-5 pounds

THE FEATURES DETAILED ABOVE ARE OFFERED IN ADDITION TO THE STANDARD FEATURES FOUND ON EVERY KIMBER 1911 LISTED ON PAGE 8.

MODEL	ITEM	CALIBER	BARREL (Inches)	WEIGHT (Ounces)
Stainless™ II	3200328	.45 ACP	5	38
Stainless™ II	3200327	9mm	5	38
Stainless Target™ II	3200325	.45 ACP	5	38
Stainless Target™ II	3200326	9mm	5	38
NEW Stainless Target (LS)	3000373	.45 ACP	6	42
NEW Stainless Target (LS)	3000372	10 mm	6	42
Stainless Pro Carry™ II	3200324	.45 ACP	4	28
Stainless Pro Carry™ II	3200323	9mm	4	28
Stainless Ultra Carry™ II	3200330	.45 ACP	3	25
Stainless Ultra Carry™ II	3200329	9mm	3	25

A complete presentation of specifications and features begins on page 74.

THE ACCURACY, dependability and renowned Kimber features of this family set the standard against which all other 1911 brands and models are measured. Their legendary performance has made Kimber the world's largest producer of 1911 pistols. The Stainless II is built entirely from stainless steel while the Pro and

Ultra models have stainless steel slides and lightweight aluminum frames. The Stainless Target (LS), new for 2018, brings the 6-inch barrel length and series I configuration to this benchmark family. Combine these foundations with the slim nature of the 1911 and you have the cornerstone in carry and concealability.

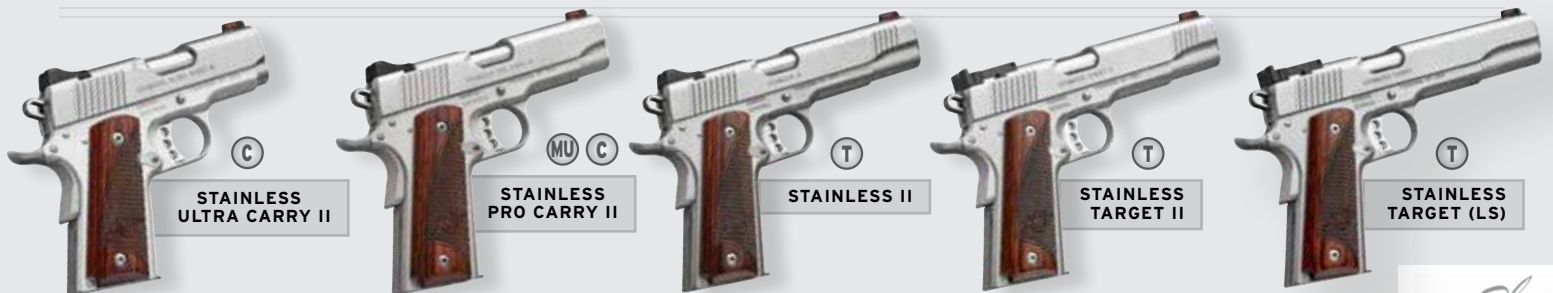

TLE II

Low-profile 3-dot tritium night sights

Flat top slide

Optional Kimber Tactical Rail and TFS (Threaded for Suppression) barrel

Kimber's match grade trigger breaks crisp and clean at 4-5 pounds

Aggressively textured G-10 grips

30 lines-per-inch front strap checkering

MU LE HD

CUSTOM TLE/RL II (EM)

Extended magwell

THE FEATURES DETAILED ABOVE ARE OFFERED IN ADDITION TO THE STANDARD FEATURES FOUND ON EVERY KIMBER 1911 LISTED ON PAGE 8.

THE TLE (Tactical Law Enforcement) family of pistols is well-suited for duty carry, tactical applications and personal protection. This group of 1911s features an integrated mainspring lanyard slot, aggressive G-10 grips and a flat top slide. Created for and in cooperation with law enforcement and military experts, TLE models are professional tools

outfitted with performance-enhancing features that also meet the defensive pistol needs of civilians. Available with barrels threaded for suppression, extended magwell (EM) options and a variety of rail and caliber options, the TLE family offers a configuration that meets almost any requirement. When you carry a Kimber, you carry with absolute confidence.

1911 PISTOLS



C LE
**STAINLESS ULTRA
 TLE II**
ULTRA TLE II



C MU LE
**STAINLESS PRO
 TLE/RL II**
PRO TLE/RL II



C MU LE
STAINLESS PRO TLE II
PRO TLE II



C MU LE
PRO TLE II (EM)



MU LE HD
CUSTOM TLE II
CUSTOM TLE II (EM)



MU LE HD
CUSTOM TLE/RL II
CUSTOM TLE/RL II (EM)



MU LE HD
CUSTOM TLE/RL II TFS



MU LE HD
STAINLESS TLE/RL II



MU LE HD
STAINLESS TLE II

MODEL	ITEM	CALIBER	BARREL (Inches)	WEIGHT (Ounces)
Ultra TLE™ II	3200341	.45 ACP	3	25
Stainless Ultra TLE™ II	3200348	.45 ACP	3	25
Pro TLE™ II (EM)	3200371	.45 ACP	4	35
Pro TLE™ II	3200340	.45 ACP	4	35
Pro TLE/RL™ II	3200361	.45 ACP	4	36
Stainless Pro TLE™ II	3200345	.45 ACP	4	35
Stainless Pro TLE/RL™ II	3200344	.45 ACP	4	36
Custom TLE™ II (EM)	3200369	.45 ACP	5	38
Custom TLE™ II	3200335	.45 ACP	5	38
Custom TLE™ II	3200347	10mm	5	38

MODEL	ITEM	CALIBER	BARREL (Inches)	WEIGHT (Ounces)
Stainless TLE™ II	3200342	.45 ACP	5	38
Custom TLE/RL™ II	3200336	.45 ACP	5	39
Custom TLE/RL™ II (EM)	3200370	.45 ACP	5	39
Custom TLE/RL™ II	3200338	10mm	5	39
Stainless TLE/RL™ II	3200343	.45 ACP	5	39
Custom TLE/RL™ II TFS	3200337	.45 ACP	5	39
Custom TLE/RL™ II TFS	3200339	9mm	5	39

A complete presentation of specifications and features begins on page 74.

ECLIPSE

All models feature tritium night sights

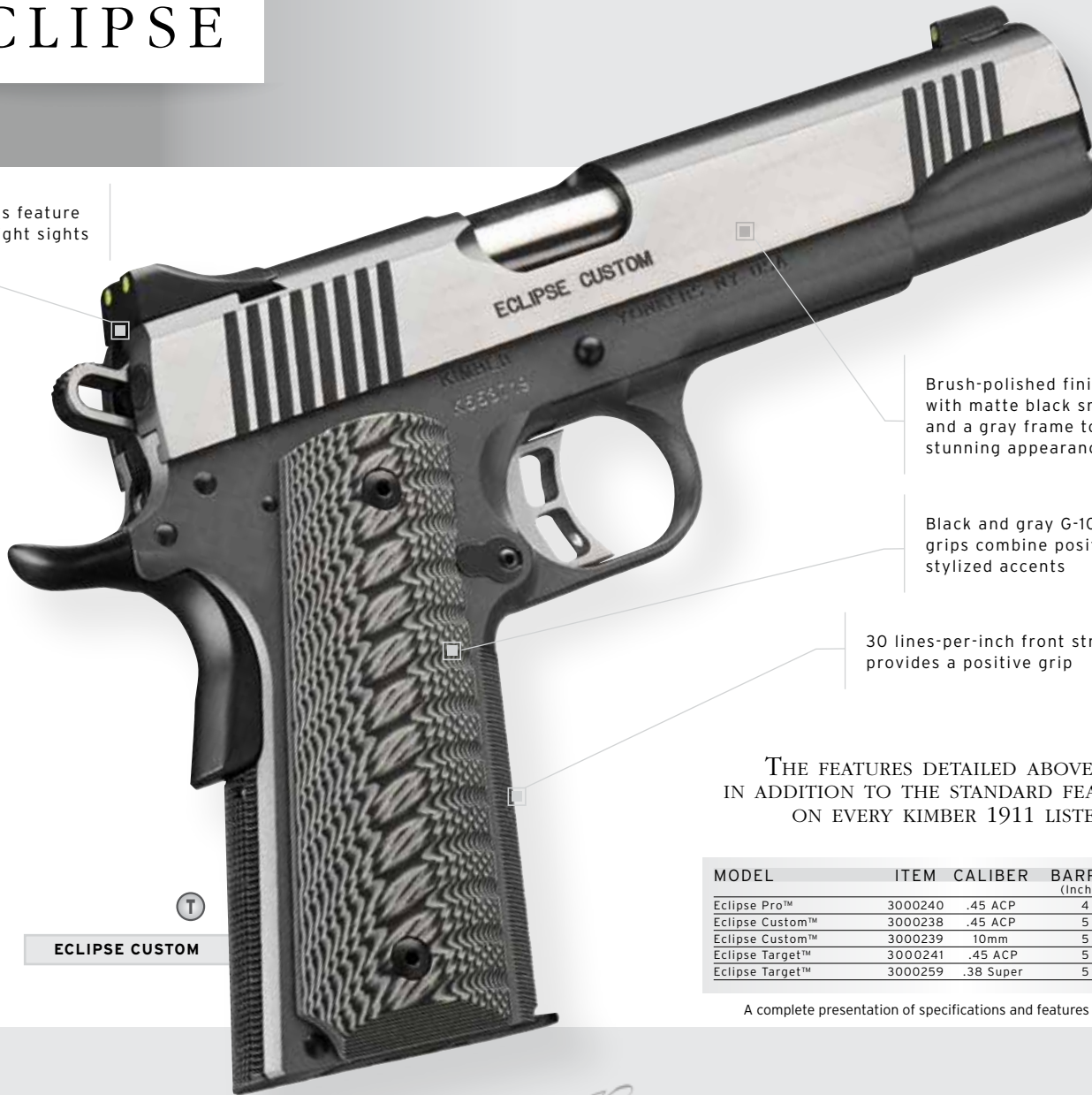

Brush-polished finish combines with matte black small parts and a gray frame to create a stunning appearance

Black and gray G-10 "Cyclone" grips combine positive grip with stylized accents

30 lines-per-inch front strap checkering provides a positive grip

THE FEATURES DETAILED ABOVE ARE OFFERED IN ADDITION TO THE STANDARD FEATURES FOUND ON EVERY KIMBER 1911 LISTED ON PAGE 8.

MODEL	ITEM	CALIBER	BARREL (Inches)	WEIGHT (Ounces)
Eclipse Pro™	3000240	.45 ACP	4	35
Eclipse Custom™	3000238	.45 ACP	5	38
Eclipse Custom™	3000239	10mm	5	38
Eclipse Target™	3000241	.45 ACP	5	38
Eclipse Target™	3000259	.38 Super	5	38

A complete presentation of specifications and features begins on page 74.

T
ECLIPSE CUSTOM

KIMBER ECLIPSE PISTOLS feature all-steel construction with a brush-polished slide over a new charcoal gray frame while matte black small parts provide an appropriate finishing touch. Custom Shop additions include 30 lines-per-inch checkering on the front strap and a Premium Aluminum Trigger™. While the Eclipse

finish is striking, performance is what matters. All models can be chambered in .45 ACP, and the Eclipse Custom is also available in 10mm. The Eclipse Target features adjustable target sights and is available in .38 Super and .45 ACP. All models are completed with G-10 grips. Performance has never looked so good.



C
ECLIPSE PRO



C MU
ECLIPSE CUSTOM

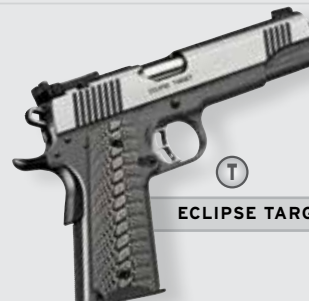

T
ECLIPSE TARGET

WARRIOR



Ambidextrous thumb safety

Lanyard slot and bumped grip safety

G-10 grips and 24 lines-per-inch front strap checkering

Tactical Wedge or suppressor-height night sights (model dependent)

Kimber Tactical Rail permits quick and secure accessory attachment

KimPro® II finish offers outstanding additional resistance to chemicals, moisture, salt and UV light

Barrel threaded for suppression (TFS) (model dependent)

MU LE HD

DESERT WARRIOR (TFS)

THE FEATURES DETAILED ABOVE ARE OFFERED IN ADDITION TO THE STANDARD FEATURES FOUND ON EVERY KIMBER 1911 LISTED ON PAGE 8.

MODEL	ITEM	CALIBER	BARREL (Inches)	WEIGHT (Ounces)
Warrior®	3000252	.45 ACP	5	40
Desert Warrior®	3000236	.45 ACP	5	40
Desert Warrior® (TFS)	3000237	.45 ACP	5.5	40
Warrior® SOC	3000253	.45 ACP	5	40
Warrior® SOC (TFS)	3000255	.45 ACP	5.5	40

A complete presentation of specifications and features begins on page 74.

WARRIOR MODELS ARE HIGHLY REFINED technical pistols loaded with features that enhance real-world performance — they are the realization of the 1911 as a tool of military and law enforcement. The Kimber Tactical Rail permits the quick and secure mounting of accessories, Tactical Wedge night sights ensure low-light performance, and new G-10 grips as well as aggressive 24 lines-per-inch front strap checkering ensure a secure grip. Standard features

include a military-length guide rod for quick field takedown, tough new KimPro® II self-lubricating finish, ambidextrous thumb safety and a lanyard slot for additional retention options. Warrior models are offered in a variety of finish options, and two are available with barrels threaded for suppression, making this family of pistols the perfect choice for personal protection or home defense.



MU LE HD

WARRIOR



MU LE HD

DESERT WARRIOR (TFS)

DESERT WARRIOR



MU LE HD

WARRIOR SOC (TFS)

WARRIOR SOC



CDP

Low-profile tritium night sights

Aggressive slide serrations

Gray KimPro® II frame, KimPro® II on slide, and small parts for added protection

Rosewood double diamond grips (Crimson Trace Lasergrips® available on Ultra CDP™)

Round Heel Frame on Ultra models

Flat top slide

Flush-cut barrel (on Ultra models)

Carry Melt™ treatment rounds edges for smooth carry

30 lines-per-inch front strap and under trigger guard checkering with high undercut trigger guard for positive grip

THE FEATURES DETAILED ABOVE ARE OFFERED IN ADDITION TO THE STANDARD FEATURES FOUND ON EVERY KIMBER 1911 LISTED ON PAGE 8.

MODEL	ITEM	CALIBER	BARREL (Inches)	WEIGHT (Ounces)
Ultra CDP™	3000245	.45 ACP	3	25
Ultra CDP™ (LG)*	3000257	.45 ACP	3	25
Ultra CDP™	3000256	9mm	3	25
Ultra+ CDP™	3000251	.45 ACP	3	27
Pro CDP™	3000243	.45 ACP	4	28
Pro CDP™	3000258	9mm	4	28
Custom CDP™	3000234	.45 ACP	5	31

*Includes Crimson Trace Lasergrips®. A complete presentation of specifications and features begins on page 74.

CDP (CUSTOM DEFENSE PACKAGE) pistols combine all the best carry features into a package that gives them their name. Adding these features during production reduces the price of these pistols by over \$600, making them an incredible value. Featuring tritium night sights dovetail mounted on a stainless steel slide, flush cut barrel, and the lightweight aluminum frame has 30 lines-per-inch checkering on the front strap and trigger guard. The frame, slide and small parts wear

our KimPro® II finishes that are self-lubricating and resistant to moisture and salt. The Carry Melt™ treatment rounds and blends edges so they will not hang up on clothing. The Ultra-sized pistol features a Round Heel Frame and flush-cut barrel. Available in 4 sizes and configurations for any concealed carry or personal defense application, CDP pistols have no equal for carry and defense—just what you expect from Kimber.

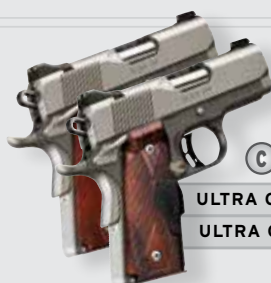

ULTRA CDP (LG)
ULTRA CDP



ULTRA + CDP

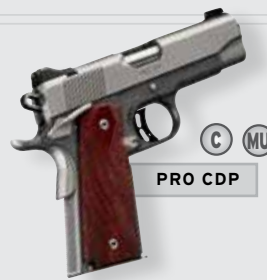

PRO CDP

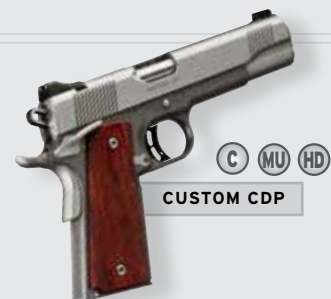

CUSTOM CDP

SUPER CARRY



Tritium night sights with cocking shoulder

Directionally engaged slide serrations

Carry Melt™ treatment rounds edges so they will not cut or snag, while a KimPro® II finish provides resistance to the elements

Round Heel Frame makes each pistol easy to conceal and comfortable to carry

C MU

SUPER CARRY CUSTOM

THE FEATURES DETAILED ABOVE ARE OFFERED IN ADDITION TO THE STANDARD FEATURES FOUND ON EVERY KIMBER 1911 LISTED ON PAGE 8.

MODEL	ITEM	CALIBER	BARREL (Inches)	WEIGHT (Ounces)
Super Carry Ultra™	3000248	.45 ACP	3	25
Super Carry Ultra+™	3000268	.45 ACP	3	27
Super Carry Pro™	3000247	.45 ACP	4	28
Super Carry Custom™	3000246	.45 ACP	5	31

A complete presentation of specifications and features begins on page 74.

SUPER CARRY .45 ACP PISTOLS establish a new standard for concealed carry and personal defense. They were designed with a single purpose: to be the finest concealed carry pistols ever offered. Super Carry models have a lightweight aluminum frame specifically for lightweight carry. All have specialized

features like night sights with cocking shoulder, directionally engaging slide serrations for positive operation and a Round Heel Frame for snag-free and comfortable carry. There is no better pistol to have on your side.



C
SUPER CARRY ULTRA



C
SUPER CARRY ULTRA+

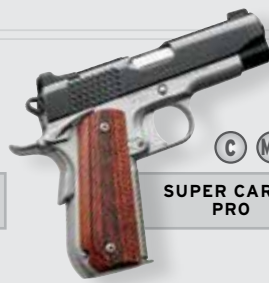

C MU
SUPER CARRY PRO

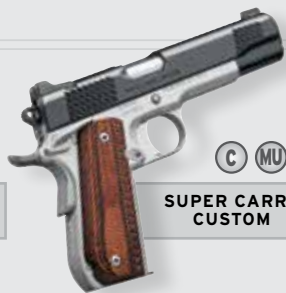

C MU HD
SUPER CARRY CUSTOM



CRIMSON CARRY II



All three sizes are available with either a red or green laser

Elegant two-tone, non-reflective finish

Crimson Trace Lasergrips® wear an exclusive rosewood finish with classic 1911 double diamond checkering and the Kimber logo

THE FEATURES DETAILED ABOVE ARE OFFERED IN ADDITION TO THE STANDARD FEATURES FOUND ON EVERY KIMBER 1911 LISTED ON PAGE 8.

C HD MU

PRO CRIMSON CARRY II

MODEL	ITEM	CALIBER	BARREL (Inches)	WEIGHT (Ounces)
Ultra Crimson Carry™ II* (Green)	3200290	.45 ACP	3	25
Ultra Crimson Carry™ II* (Red)	3200191	.45 ACP	3	25
Pro Crimson Carry™ II* (Green)	3200289	.45 ACP	4	28
Pro Crimson Carry™ II* (Red)	3200190	.45 ACP	4	28
Custom Crimson Carry™ II* (Green)	3200288	.45 ACP	5	31
Custom Crimson Carry™ II* (Red)	3200189	.45 ACP	5	31

*Includes Crimson Trace Lasergrips®. A complete presentation of specifications and features begins on page 74.

HAVING CONFIDENCE in a carry pistol is critical. Every Crimson Carry pistol has a lightweight aluminum frame for easy carry, and each is fitted with Crimson Trace Lasergrips® that project a bright red or green dot visible in virtually any light. Crimson Trace Lasergrips® are among the finest laser sights available, providing a significant psychological and

practical application that increases both speed and accuracy under stress. The combination of Crimson Trace Lasergrips® with Kimber quality and dependability make Crimson Carry II pistols an unbeatable value. Available in three sizes, these pistols are well-suited for personal defense, concealed carry and home defense.

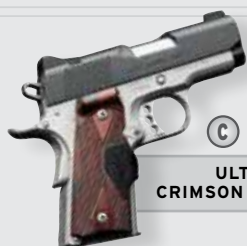

C

ULTRA CRIMSON CARRY II



HD MU

PRO CRIMSON CARRY II

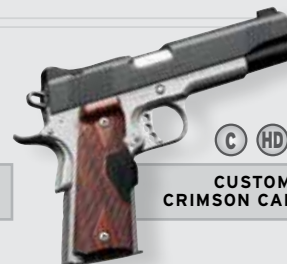

C HD MU

CUSTOM CRIMSON CARRY II

RAPTOR II



Tactical Wedge night sights (Grand Raptor™ II features adjustable night sights)

Scaled slide serrations and ambidextrous thumb safety

Striking grips with scale pattern complete this patented pistol design

Back-cut row of large scales runs along the back strap. (Ultra models have a Round Heel Frame)

Flush-cut barrel (on Ultra models)

Back-cut row of larger scales along the flat top of the slide

Brush-polished flats (Grand Raptor II features highly polished flats)

STAINLESS ULTRA RAPTOR II

THE FEATURES DETAILED ABOVE ARE OFFERED IN ADDITION TO THE STANDARD FEATURES FOUND ON EVERY KIMBER 1911 LISTED ON PAGE 8.

MODEL	ITEM	CALIBER	BARREL (Inches)	WEIGHT (Ounces)
Ultra Raptor™ II	3200378	.45 ACP	3	25
Stainless Ultra Raptor™ II	3200375	.45 ACP	3	25
Stainless Ultra Raptor™ II	3200374	9mm	3	25
Pro Raptor™ II	3200118	.45 ACP	4	35
Stainless Pro Raptor™ II	3200195	.45 ACP	4	35
Stainless Pro Raptor™ II	3200365	9mm	4	35
Raptor™ II	3200117	.45 ACP	5	38
Stainless Raptor™ II	3200181	.45 ACP	5	38
Stainless Raptor™ II	3200366	9mm	5	38
Grand Raptor™ II	3200128	.45 ACP	5	38

A complete presentation of specifications and features begins on page 74.

RAPTOR PISTOLS TAKE their name from a combination of aggressive slide and frame serrations, feathered logo grips and special scaled texturing accents. While this patented design is unique, the features, dependability and accuracy are pure Kimber. Tritium night sights, ambidextrous thumb safety and a

bumped and grooved grip safety are all standard with the Raptor family. Stainless Raptors offer a choice of calibers, 9mm or .45 ACP, and all Ultra models feature a Round Heel Frame. The quality of the Kimber 1911 rivals America's finest gunsmiths; hold a Raptor and see for yourself.



ULTRA RAPTOR II
STAINLESS ULTRA RAPTOR II

PRO RAPTOR II
STAINLESS PRO RAPTOR II

RAPTOR II
STAINLESS RAPTOR II

GRAND RAPTOR II



MASTER CARRY

Tactical Wedge night sights maximize low-light performance

KimPro® II finish on slide provides additional resistance to moisture

Serrated mainspring housing contributes to a secure grip, which speeds sight picture recovery between shots

Aggressive yet comfortable G-10 grips with Crimson Trace® laser provide a positive grip and improve sight picture

THE FEATURES DETAILED ABOVE ARE OFFERED IN ADDITION TO THE STANDARD FEATURES FOUND ON EVERY KIMBER 1911 LISTED ON PAGE 8.

MASTER CARRY PRO

Round Heel Frame aids in concealability and comfortable carry

MODEL	ITEM	CALIBER	BARREL (Inches)	WEIGHT (Ounces)
Master Carry Ultra™*	3000284	.45 ACP	3	25
Master Carry Pro™*	3000283	.45 ACP	4	28
Master Carry Pro™*	3000242	9mm	4	28
Master Carry Custom™*	3000282	.45 ACP	5	38

*Includes Crimson Trace Lasergrips®.
A complete presentation of specifications and features begins on page 74.

THE MASTER CARRY FAMILY of .45 ACP pistols combine Kimber performance and popular concealed carry features into one extraordinary package. Tactical Wedge tritium night sights, a Round Heel Frame with serrated mainspring housing and Crimson Trace Master Series™ Lasergrips® are all standard. KimPro® II finish on the slide provides additional resistance to

the elements, and rounded edges on the frame and slide will not snag clothing or holsters. The Master Carry Custom has a stainless steel frame, while the Master Carry Pro and the Master Carry Ultra have lightweight aluminum frames. Whichever you choose, any member of the Master Carry family is sure to meet every need.



MASTER CARRY ULTRA



MASTER CARRY PRO

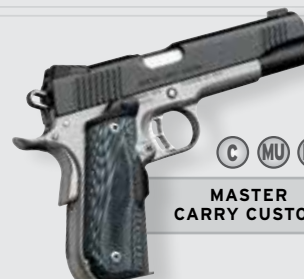

MASTER CARRY CUSTOM

COVERT

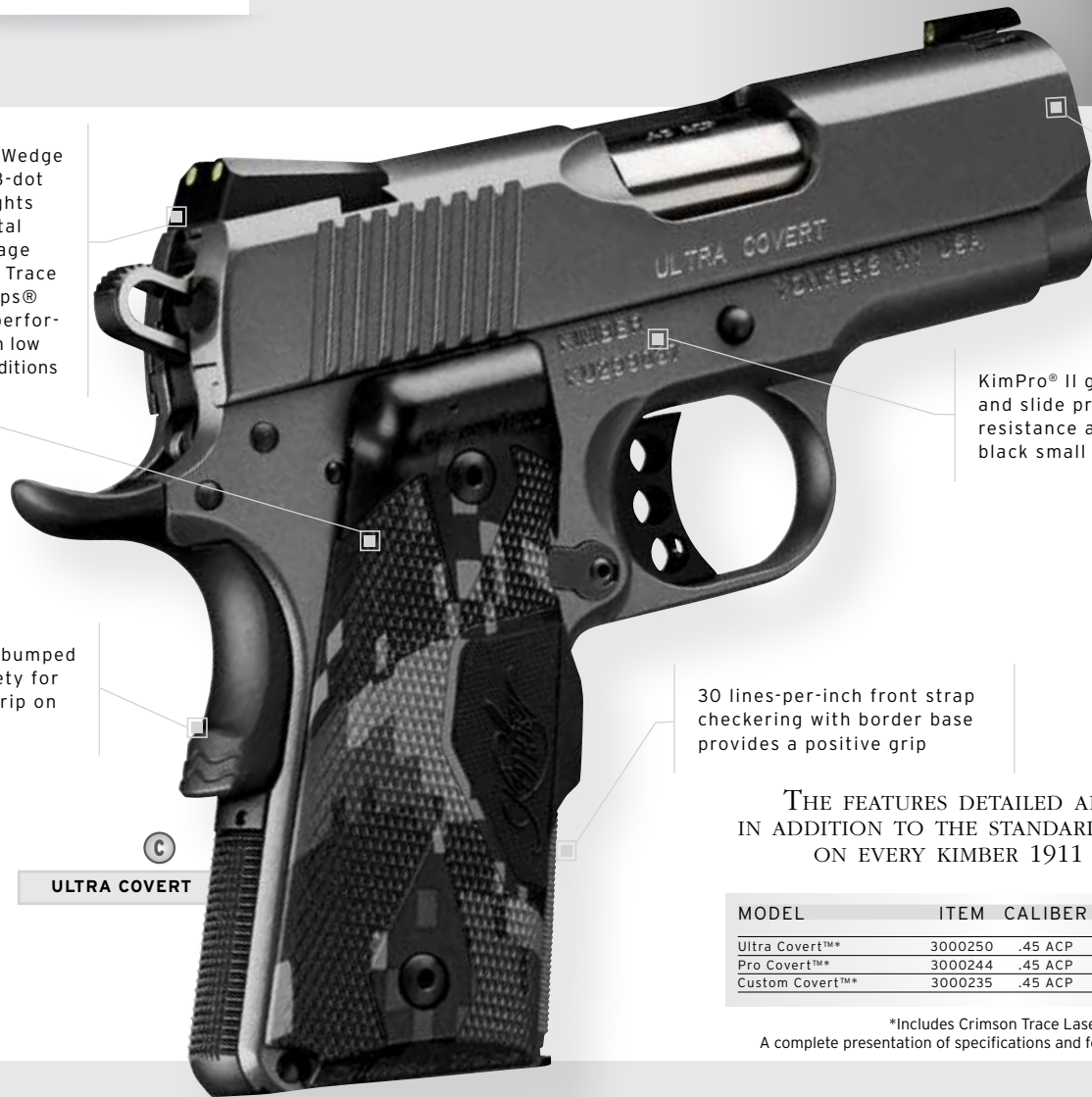

Tactical Wedge tritium 3-dot night sights and digital camouflage Crimson Trace Lasergrips® ensure performance in low light conditions

Flush-cut barrel (on Ultra models)

KimPro® II gray finish on the frame and slide provides additional moisture resistance and is accented by matte black small parts

Tactical bumped grip safety for higher grip on frame

30 lines-per-inch front strap checkering with border base provides a positive grip

C
ULTRA COVERT

THE FEATURES DETAILED ABOVE ARE OFFERED IN ADDITION TO THE STANDARD FEATURES FOUND ON EVERY KIMBER 1911 LISTED ON PAGE 8.

MODEL	ITEM	CALIBER	BARREL (Inches)	WEIGHT (Ounces)
Ultra Covert™*	3000250	.45 ACP	3	25
Pro Covert™*	3000244	.45 ACP	4	28
Custom Covert™*	3000235	.45 ACP	5	31

*Includes Crimson Trace Lasergrips®. A complete presentation of specifications and features begins on page 74.

THE NEW COVERT .45 ACP PISTOLS are the perfect combination of light weight and meaningful features. With a gray color palette, flush-cut barrel and Round Heel Frame on Ultra models, Covert pistols feature both Crimson Trace Lasergrips® and Tactical Wedge tritium night sights; two sight systems that will ensure you acquire your sight picture regardless of light conditions. The 30 lines-per-inch front strap checkering with a bordered base helps ensure a positive grip even

with cold, wet or gloved hands. The Carry Melt™ treatment contours, rounds and blends all edges so they will not snag on clothing or holsters. A bumped and grooved beavertail grip safety provides control under stress, while the mainspring housing with lanyard slot on the Custom and Pro models add an extra level of safeguard if needed. Kimber Covert quality ensures unequaled accuracy and dependability; there is no reason to be afraid of the dark.



KHX



Fiber optic sights

KimPro® II gray finish on slide and frame

Hogue® laser equipped MagGrips have a red laser and create a mag-well. G-10 grip surface extends to mainspring housing

Stiplex front strap texture for positive grip

Hexagonal pattern serrations on slide stair-stepped in height for maximum grip surface

THE FEATURES DETAILED ABOVE ARE OFFERED IN ADDITION TO THE STANDARD FEATURES FOUND ON EVERY KIMBER 1911 LISTED ON PAGE 8.

T
KHX CUSTOM
NEW

	MODEL	ITEM	CALIBER	BARREL (Inches)	WEIGHT (Ounces)
NEW	KHX Ultra™*	3000371	.45 ACP	3	25
NEW	KHX Ultra™*	3000370	9mm	3	25
NEW	KHX Pro™ (OR)	3000362	.45 ACP	4	35
NEW	KHX Pro™ (OR)	3000364	9mm	4	35
NEW	KHX Pro™*	3000361	.45 ACP	4	35
NEW	KHX Pro™*	3000363	9mm	4	35
NEW	KHX Custom™ (OR)	3000360	.45 ACP	5	38
NEW	KHX Custom™ (OR)	3000374	9mm	5	38
NEW	KHX Custom™*	3000358	.45 ACP	5	38
NEW	KHX Custom™*	3000359	9mm	5	38

*Includes Hogue® laser equipped grips.
A complete presentation of specifications and features begins on page 75.

KHX 1911s are loaded with features that set them apart. Hexagonal serrations on the slide and topstrap, Stiplex frontstrap surfacing, fiber optic ledged sights, a partnership with the industry's leading grip company, Hogue®, has all of the models wearing their MagGrip system that brings the grip surface to the mainspring housing. KHX Ultra, Pro, and Custom models wear the laser equipped MagGrips that feature a red laser.

Optics Ready (OR) models are milled to accept plates for some of the most popular mini red dot sights available today. Pro and Ultra models have a rounded heel frame for comfort and reduced printing during carry. Completely finished in KimPro® II gray with black small parts, these aggressively styled 1911s will find themselves at home on the range or on your person.

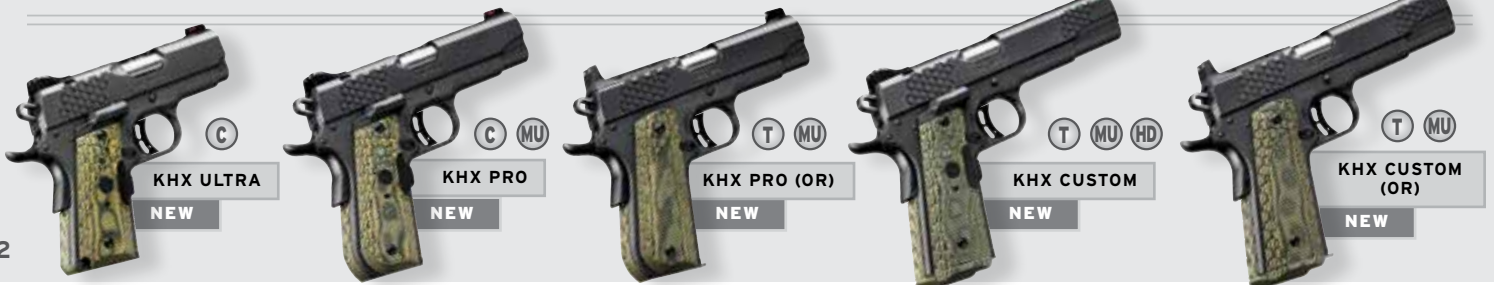

AEGIS ELITE



AEX Serrations provide innovative grip surface

Vortex® Venom® Red Dot installed with 6MOA dot and white dot co-witness sights

24LPI front strap checkering

G-10 green, black and gray grips

Serrated rounded heel frame



AEGIS ELITE CUSTOM (OI)

NEW

THE FEATURES DETAILED ABOVE ARE OFFERED IN ADDITION TO THE STANDARD FEATURES FOUND ON EVERY KIMBER 1911 LISTED ON PAGE 8.

	MODEL	ITEM	CALIBER	BARREL (Inches)	WEIGHT (Ounces)
NEW	Aegis Elite Ultra™	3000356	.45 ACP	3	25
NEW	Aegis Elite Ultra™	3000357	9mm	3	25
NEW	Aegis Elite Pro™ (OI)	3000355	.45 ACP	4	36.6
NEW	Aegis Elite Pro™ (OI)	3000354	9mm	4	36.6
NEW	Aegis Elite Pro™	3000349	.45 ACP	4	35
NEW	Aegis Elite Pro™	3000365	9mm	4	35
NEW	Aegis Elite Custom™ (OI)	3000352	.45 ACP	5	39.6
NEW	Aegis Elite Custom™ (OI)	3000353	9mm	5	39.6
NEW	Aegis Elite Custom™	3000351	.45 ACP	5	38
NEW	Aegis Elite Custom™	3000350	9mm	5	38

A complete presentation of specifications and features begins on page 75.

ANOTHER BRAND-NEW FAMILY making its debut in 2018 is the Aegis Elite. Rounded heel frames and two-tone styling completed with G-10 Cyclone patterned grips make these standouts in any environment. AEX pattern serrations are a stylish answer to the practical need for grip surface during reloads. Aegis Elite feature fiber optic sights on the Ultra,



Pro, and Custom models, while the Optics Installed (OI) Pro and Custom models have the Vortex® Venom® Red Dot, with a 6MOA dot, milled and installed before leaving Kimber. Remaining true to Kimber's original purpose, this puts an otherwise custom gun within the reach of every shooter's hands.

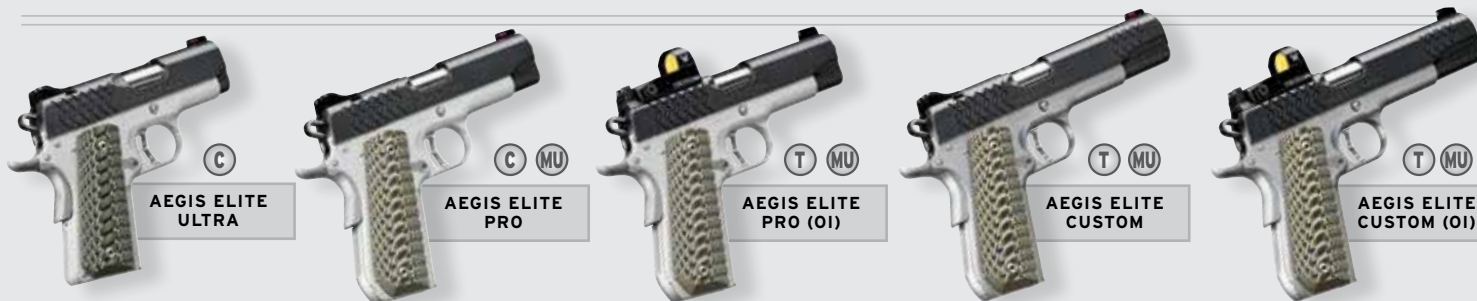

AEGIS ELITE ULTRA

AEGIS ELITE PRO

AEGIS ELITE PRO (OI)

AEGIS ELITE CUSTOM

AEGIS ELITE CUSTOM (OI)

GOLD MATCH II

Rear adjustable sights

Extended ambidextrous thumb safety

Premium Aluminum Trigger™

Team Match® II features an extended magazine well and 30 lines-per-inch front strap checkering



The Team Match® II was created in cooperation with the **USA Shooting Rapid Fire Pistol Team** to train for the Olympics. Kimber is the largest donor of any firearm manufacturing company in team history, contributing over \$1 million to date.

THE FEATURES DETAILED ABOVE ARE OFFERED IN ADDITION TO THE STANDARD FEATURES FOUND ON EVERY KIMBER 1911 LISTED ON PAGE 8.

T

TEAM MATCH II

MODEL	ITEM	CALIBER	BARREL (Inches)	WEIGHT (Ounces)
Team Match® II	3200376	.45 ACP	5	38
Team Match® II	3200377	9mm	5	38
Gold Match™ II	3200354	.45 ACP	5	38
Stainless Gold Match™ II	3200355	.45 ACP	5	38

A complete presentation of specifications and features begins on page 75.

GOLD MATCH PISTOLS deliver a standard of performance unequaled by any other brand or model of production 1911, and they best many full-custom pistols as well. Each Gold Match model has a stainless steel match grade barrel fitted by hand for exceptional accuracy and looks as good as it shoots, with flat surfaces polished to a high shine and contrasting satin over the curves. Features include an ambidextrous thumb safety, adjustable sights, serrated flat top slide,

match grade Premium Aluminum Trigger™, 30 lines-per-inch front strap checkering and elegant rosewood grips. Team Match® II wears Kimber's tough KimPro® II finishes on both the frame and slide, and features an engraved 24-karat gold USA Shooting logo. Designed for competition, the accuracy and dependability of Gold Match pistols have made them a favorite for all-around use.

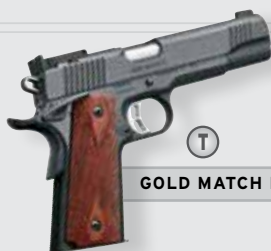

T

GOLD MATCH II



T

STAINLESS
GOLD MATCH II

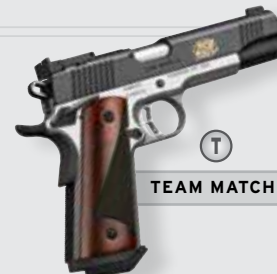

T

TEAM MATCH II

RIMFIRE CONVERSION KITS

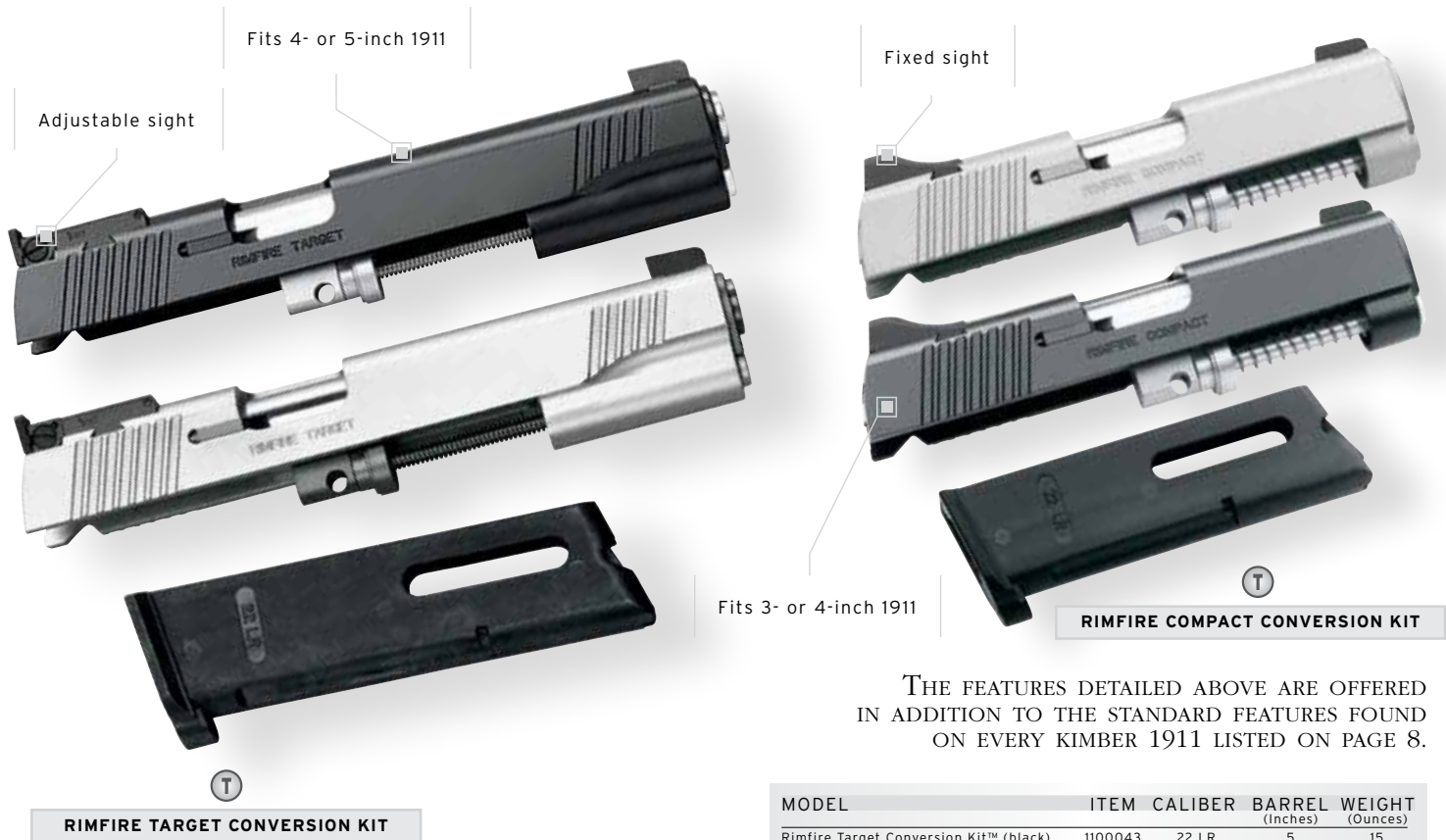

THE FEATURES DETAILED ABOVE ARE OFFERED IN ADDITION TO THE STANDARD FEATURES FOUND ON EVERY KIMBER 1911 LISTED ON PAGE 8.

MODEL	ITEM	CALIBER	BARREL (Inches)	WEIGHT (Ounces)
Rimfire Target Conversion Kit™ (black)	1100043	.22 LR	5	15
Rimfire Target Conversion Kit™ (silver)	1100044	.22 LR	5	15
Rimfire Compact Conversion Kit™ (black)	1100479	.22 LR	4	13
Rimfire Compact Conversion Kit™ (silver)	1100485	.22 LR	4	13

A complete presentation of specifications and features begins on page 75.



SHOOTING A RIMFIRE is an effective way to teach new shooters and enhance the training of others, regardless of their level of experience. Our Rimfire Target Conversion Kit™ (fits 4- and 5-inch barrel models) and Rimfire Compact Conversion Kit™ (fits 3- and 4-inch barrel models) are compatible with

Kimber and most other MIL-SPEC 1911 pistols. Conversion kits are designed to operate with high velocity .22 LR ammunition. Adding a Rimfire Conversion Kit to any 1911 gives you two pistols in one and pays for itself in just a few hundred rounds.

SPECIAL EDITIONS

Fiber optic sights

Boot Campaign logo engraved on topstrap

Black KimPro® II finish on the slide with U.S. flag engraving

Desert Tan KimPro® II frame

BOOT 
CAMPAIGN

Boot Campaign provides programs and initiatives to help veterans and military families transition from military life to civilian life. Kimber is a proud sponsor of Boot Campaign.

Kryptek Highlander™ patterned grips



HERO CUSTOM
NEW

Integrated lanyard loop

THE FEATURES DETAILED ABOVE AND ON THE OPPOSITE PAGE ARE OFFERED IN ADDITION TO THE STANDARD FEATURES FOUND ON EVERY KIMBER 1911 LISTED ON PAGE 8.

KIMBER CONTINUES IN ITS TRADITION of providing custom finishes and features that stand out in a crowd. Making a statement above and beyond the ordinary, the Kimber Custom Shop offers striking gem-tone finishes with the quality and dependability you expect. Both the gemstone and precious metal collections feature polished PVD-finished slides and small parts. Slides are accented by intricate engraving and topped with tritium night sights. Coordinating grips are slim, allowing for

increased hand contact for any size of hand. The RMEF® Camp Guard 10™, the ultimate backcountry protection, and Stainless II (Engraved Edition), a beautiful testament to skilled engraving, find themselves in good company with the Hero Custom—new for 2018 and in partnership with the Boot Campaign. With Kimber, performance and reliability are not compromised when unique finishing details are desired.



ROSE GOLD ULTRA II

- Highly polished stainless steel slide with rose gold PVD coating and cut scroll engraving and border
- Rose gold PVD-coated small parts
- Round Heel Frame
- Ball-milled grooves on front strap
- Thin ball-milled G-10 grips
- Ambidextrous safety and Tactical Wedge night sights



SAPPHIRE PRO II

- Highly polished stainless steel slide with sapphire blue PVD coating and cut scroll engraving and border
- Sapphire blue PVD-coated small parts
- Ball-milled grooves on front strap
- Thin ball-milled G-10 grips
- Ambidextrous safety and Tactical Wedge night sights



SAPPHIRE ULTRA II

- Highly polished stainless steel slide with sapphire blue PVD coating and cut scroll engraving and border
- Sapphire blue PVD-coated small parts
- Round Heel Frame
- Ball-milled grooves on front strap
- Thin ball-milled G-10 grips
- Ambidextrous safety and Tactical Wedge night sights



AMETHYST ULTRA II

- Highly polished stainless steel slide with amethyst purple PVD coating and cut scroll engraving and border
- Amethyst purple PVD-coated small parts
- Round Heel Frame
- Ball-milled grooves on front strap
- Thin ball-milled G-10 grips
- Ambidextrous safety and Tactical Wedge night sights



CAMP GUARD 10

- KimPro® II finish provides resistance to the elements
- Custom RMEF® carved rosewood grips
- Round Heel Frame
- Tactical Wedge tritium 3-dot night sights



STAINLESS II (CLASSIC ENGRAVED EDITION)

- Full-coverage vine and leaf tool engraving with stipple relief on frame and slide
- Accent-engraved mainspring housing
- High-grade walnut grips with ivory Micarta checkered inlay

MODEL	ITEM	CALIBER	BARREL (Inches)	WEIGHT (Ounces)
NEW Hero Custom™	3200383	.45 ACP	5	38
Sapphire Ultra™ II	3200362	.45 ACP	3	25
Sapphire Ultra™ II	3200273	9mm	3	25
Sapphire Pro™ II	3200298	9mm	4	28
Camp Guard 10™	3000233	10mm	5	38

MODEL	ITEM	CALIBER	BARREL (Inches)	WEIGHT (Ounces)
Rose Gold Ultra™ II	3200373	.45 ACP	3	25
Rose Gold Ultra™ II	3200372	9mm	3	25
Amethyst Ultra™ II	3200363	.45 ACP	3	25
Amethyst Ultra™ II	3200319	9mm	3	25
Stainless™ II (Classic Engraved Edition)	3200314	.45 ACP	5	38

A complete presentation of specifications and features begins on page 75.

CUSTOM SHOP

Leupold DeltaPoint®
Pro rear-mounted
red-dot sight

Ported 6-inch
barrel and slide
to enhance recoil
management

Stainless steel slide
and frame

Tough Diamond-Like
Carbon (DLC) finish
on slide

Two-hole trigger

Ambidextrous
thumb safety

High undercut under
the trigger guard

Green and black G-10 grips with
black checkered inlay and serrated
front strap for positive grip

SUPER JÄGARE

Round Heel Frame

THE FEATURES DETAILED ABOVE AND ON THE
OPPOSITE PAGE ARE OFFERED IN ADDITION TO
THE STANDARD FEATURES FOUND ON EVERY
KIMBER 1911 LISTED ON PAGE 8.

EACH UNIQUE MODEL found in the Kimber Custom Shop Collection is superlative in every respect, from features to accuracy to dependability. They are the finest representatives of their class. Each pistol is pictured on these pages with a list of their key features; for more information on each model,

please visit kimberamerica.com or call (888) 243-4522. From the Super Jägare™ designed for hunting to the enhanced concealed carry features of the Ultra RCP™ II (LG) and every form, function and elegant style in between, these are collectively the finest 1911 pistols available today.



(MU) (LE)

GOLD COMBAT STAINLESS II
GOLD COMBAT II

- Stainless steel slide and frame
- KimPro® II finish
- Aggressive slide serrations
- Extended magazine well and ambidextrous thumb safety



(C)

ULTRA RCP II (LG)

- Round Heel Frame
- Trough sights
- Carry Melt™ treatment
- Bobbed controls
- Crimson Trace Lasergrips®



(C)

CLASSIC CARRY PRO

- Steel frame and slide
- Round Heel Frame
- Charcoal blue finish
- Ivory G-10 grips



(HD) (LE)

GOLD COMBAT RL II

- Kimber Tactical Rail
- Stainless steel slide and frame
- KimPro® II finish and aggressive slide serrations
- Extended magazine well and ambidextrous thumb safety



(C)

ROYAL II

- Charcoal blue finish
- Solid bone grips



(T)

SUPER MATCH II

- Serrated flat top slide
- Stainless steel slide and frame
- KimPro® II finish and aggressive slide serrations
- Extended flush magazine well and ambidextrous thumb safety
- 1-inch groups or better at 25 yards guaranteed.

MODEL	ITEM	CALIBER	BARREL (Inches)	WEIGHT (Ounces)
Classic Carry Pro™	3000277	.45 ACP	4	35
Ultra RCP™ II (LG)*	3200302	.45 ACP	3	25
Gold Combat™ II	3200184	.45 ACP	5	39
Gold Combat RL™ II	3200186	.45 ACP	5	40
Gold Combat Stainless™ II	3200185	.45 ACP	5	39
Super Match™ II	3200309	.45 ACP	5	39
Royal™ II	3200263	.45 ACP	5	38
Super Jägare™	3000278	10mm	6	42

*Includes Crimson Trace Lasergrips®.

A complete presentation of specifications and features begins on page 75.



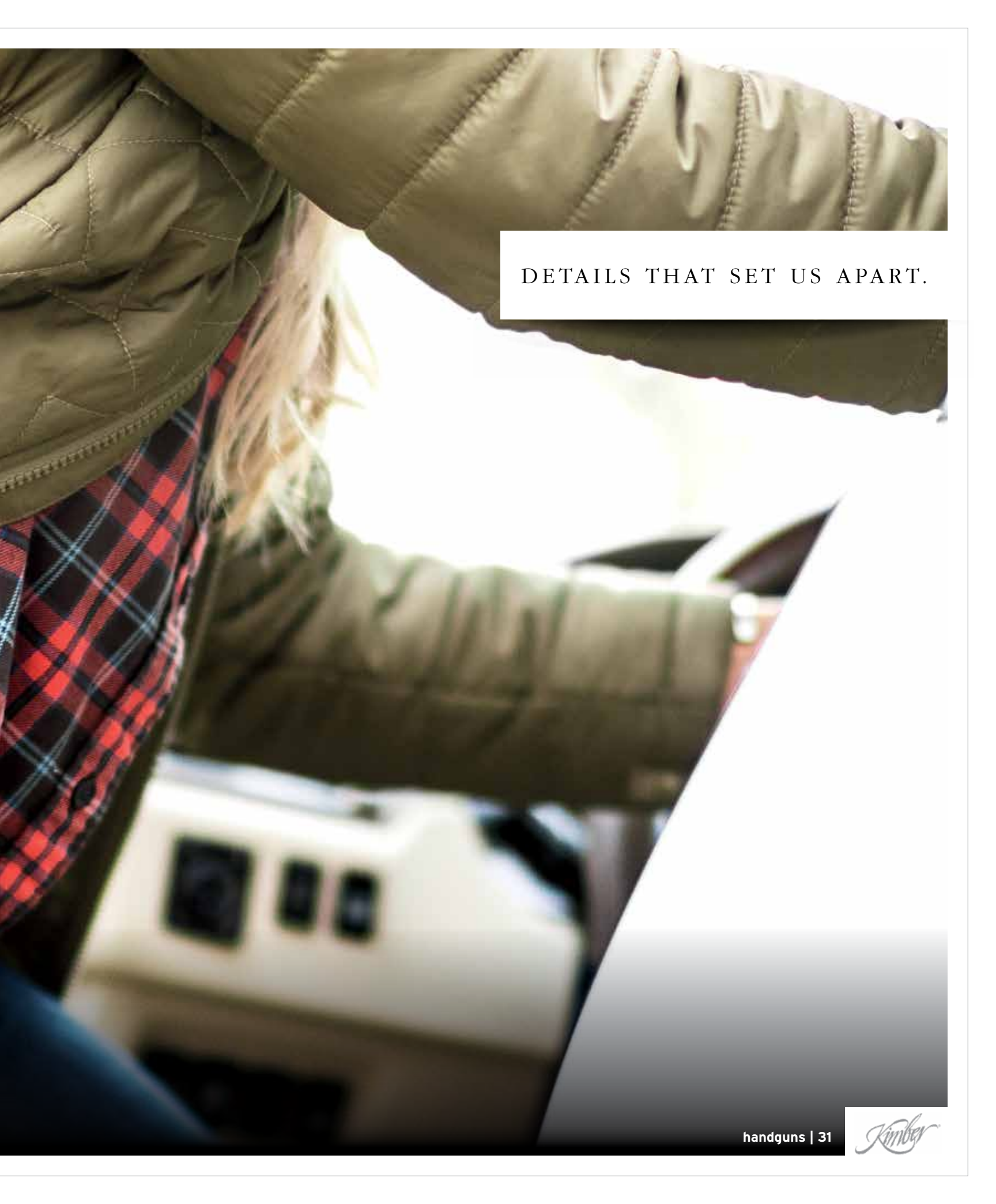

DETAILS THAT SET US APART.



MADE IN AMERICA



MICRO™ .380 ACP AND 9MM PISTOLS bring an unmatched level of safety, dependability and performance to concealed carry. Small and light, they blend Kimber quality with superior 1911-

like ergonomics and simple operation. Mild recoil and a smooth single-action trigger pull make them a pleasure to shoot.

SUPERIOR FEATURES AND DETAILS FOUND ON EVERY KIMBER MICRO PISTOL:

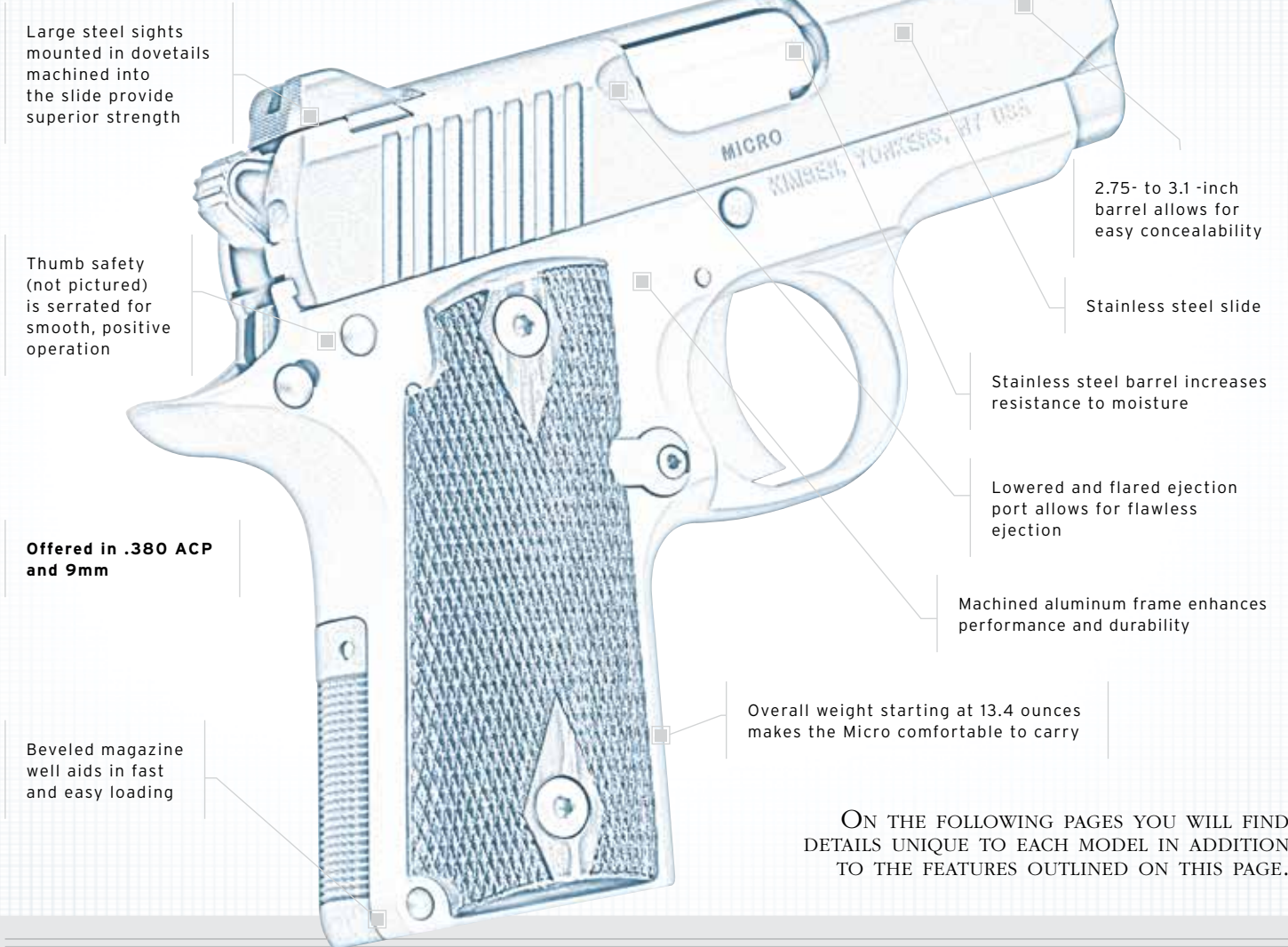

ON THE FOLLOWING PAGES YOU WILL FIND DETAILS UNIQUE TO EACH MODEL IN ADDITION TO THE FEATURES OUTLINED ON THIS PAGE.

With a starting weight of 13.4 ounces and a barrel length of 2.75 inches, Kimber Micro™ .380 ACP and 9mm pistols are easy to carry and conceal. Micro barrels are machined from stainless steel for superior resistance to moisture, and all Micro frames are shaped from the finest aluminum for integrity and strength. In many respects a miniature 1911, the Micro offers important design advantages like a single-action trigger with a short, smooth pull that ensures accuracy and builds confidence. Its thumb safety, slide stop and magazine release are pure 1911 as well. Standard features include a

lowered and flared ejection port for flawless ejection and a beveled magazine well for fast, positive loading. Sights are steel – not plastic – and mounted in machined dovetails for additional integrity. Each Micro includes an extended 7-round magazine; flush-fitting 6-round magazines are available. Well-suited for all shooters, including those with small hands and those who insist on mild recoil, Micro provides power for concealed carry, home protection and many other applications in our smallest platform yet. Best of all, they offer unequaled Kimber quality, dependability and performance.

MICRO PISTOLS

CLASSIC, COMPACT
AND ELEGANT PROTECTION.

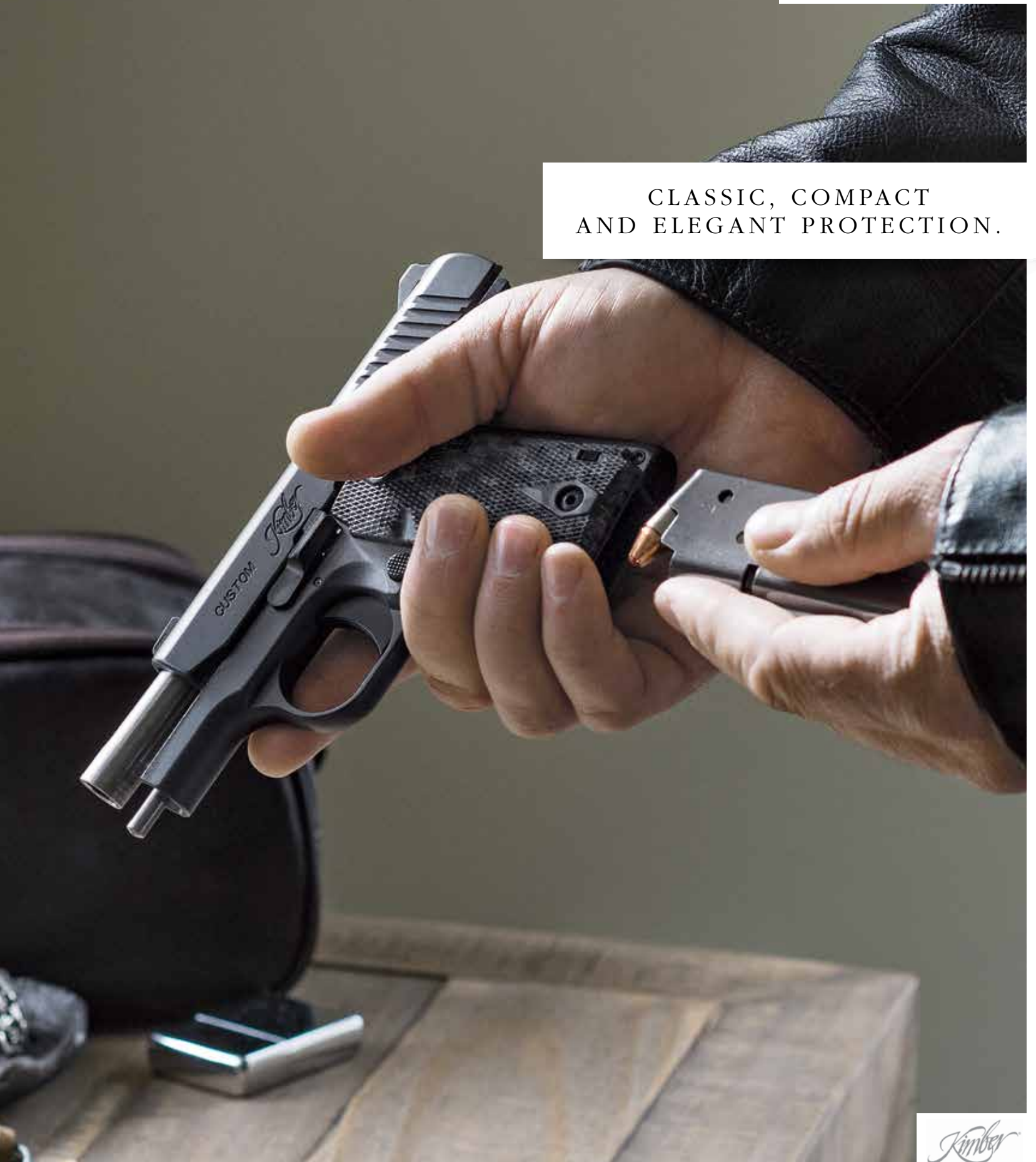

Kimber

MICRO

Tritium night sights

Checkered front strap and mainspring housing

MICRO COVERT
NEW



Carry melt treatment on slide and frame

Stainless steel slide wears KimPro® II gray finish

KimPro® II gray finish

Gray urban camo Crimson Trace Lasergrips®

THE FEATURES DETAILED ABOVE AND ON THE OPPOSITE PAGE ARE OFFERED IN ADDITION TO THE STANDARD FEATURES FOUND ON EVERY MICRO LISTED ON PAGE 32.

THE MICRO .380 ACP GROUP OF PISTOLS combines mild recoil and simple operation for the hands of shooters with no sacrifice on quality and performance. For 2018, we have extended to our .380 ACP models three of our popular 1911



family finishes and features: the Micro Covert, the Micro Eclipse, and the Micro TLE. Collectively these are the most refined, ultra-compact .380 ACPs available today.



MICRO ECLIPSE
NEW

- KimPro® II gray slide with brushed polished flats
- KimPro® II gray frame
- Gray and black Cyclone G-10 Grips
- Tritium night sights
- Checkered front strap



MICRO TLE
NEW

- KimPro® II black slide and frame
- Green and black G-10 Grips
- Tritium night sights
- Checkered front strap



MICRO STAINLESS ROSEWOOD

- Satin Silver stainless steel slide
- White dot sights
- Rosewood grips with Kimber logo



MICRO DESERT NIGHT

- KimPro® II matte-black stainless steel slide
- KimPro® II Desert Tan frame
- White dot sights
- Brown and black G-10 Grips



MICRO DESERT TAN (LG)

- KimPro® II Desert Tan stainless steel slide
- KimPro® II black frame
- White dot sights
- Tan Crimson Trace Lasergrips®

	MODEL	ITEM	CALIBER	BARREL (Inches)	WEIGHT (Ounces)
NEW	Micro Covert*	3300186	.380 ACP	2.75	13.4
NEW	Micro Eclipse	3300188	.380 ACP	2.75	13.4
NEW	Micro TLE	3300190	.380 ACP	2.75	13.4
	Micro Desert Tan™ (LG)*	3300177	.380 ACP	2.75	13.4
	Micro Desert Night™	3300167	.380 ACP	2.75	13.4
	Micro Stainless Rosewood™	3300103	.380 ACP	2.75	13.4

*Includes Crimson Trace Lasergrips®.

A complete presentation of specifications and features begins on page 76.

MICRO

Continued



(C)

MICRO ROSE GOLD

- Mirror-polished slide and small parts
- PVD color finish adds beauty and durability
- Ambidextrous thumb safety
- Rose gold and black G-10 grips
- Delicately engraved scroll accents
- Tritium night sights



(C)

MICRO AMETHYST

- Mirror-polished slide and small parts
- PVD color finish adds beauty and durability
- Ambidextrous thumb safety
- Purple and black G-10 grips
- Delicately engraved scroll accents
- Tritium night sights



(C)

MICRO SAPPHIRE

- Mirror-polished slide and small parts
- PVD color finish adds beauty and durability
- Ambidextrous thumb safety
- Blue and black G-10 grips
- Delicately engraved scroll accents
- Tritium night sights



(C)

MICRO BEL AIR

- Ivory G-10 grips
- Mirror-polished slide and small parts
- Bel Air Blue™ finish on frame
- White dot sights



(C)

MICRO RAPTOR

MICRO RAPTOR STAINLESS

- Ambidextrous thumb safety
- Slide and front strap scaling
- Tritium night sights
- Patented scaled grips
- Slide top and mainspring scalloping



(C)

MICRO TWO-TONE

- Two-tone slide and frame finish
- White dot sights
- Rosewood grips with Kimber logo

MICRO PISTOLS



C

MICRO DC (LG)
MICRO DC

- Stainless slide, KimPro® II black finish
- Tritium night sights
- Textured G-10 grips on Micro DC, black Crimson Trace Lasergrips® on Micro DC (LG)
- DLC finished barrel
- Ambidextrous thumb safety



C

MICRO RCP
MICRO RCP (LG)

- Stainless slide, KimPro® II black finish
- All-black small parts and barrel
- Trench-cut sight
- Crimson Trace Lasergrips® on Micro RCP (LG)
- Ambidextrous thumb safety



C

MICRO ADVOCATE

- Tritium night sights
- Purple or brown G-10 grips
- Ships with extended 7-round magazine



C

MICRO CDP
MICRO CDP (LG)

- Carry Melt™ treatment
- Tritium night sights
- Front strap checkering
- Rosewood grips or rosewood Crimson Trace Lasergrips®
- Ambidextrous thumb safety



C

MICRO CRIMSON CARRY

- Two-tone finish
- White dot sights
- Rosewood Crimson Trace Lasergrips®

MODEL	ITEM	CALIBER	BARREL (Inches)	WEIGHT (Ounces)
Micro Rose Gold	3300173	.380 ACP	2.75	13.4
Micro Amethyst™	3300160	.380 ACP	2.75	13.4
Micro Sapphire™	3300090	.380 ACP	2.75	13.4
Micro Bel Air™	3300091	.380 ACP	2.75	13.4
Micro Raptor™	3300087	.380 ACP	2.75	13.4
Micro Raptor Stainless™	3300084	.380 ACP	2.75	13.4
Micro™ Two-Tone	3300102	.380 ACP	2.75	13.4
Micro Crimson Carry™*	3300088	.380 ACP	2.75	13.4
Micro CDP™	3300080	.380 ACP	2.75	13.4
Micro CDP™ (LG)*	3300081	.380 ACP	2.75	13.4
Micro RCP™	3300093	.380 ACP	2.75	13.4
Micro RCP™ (LG)*	3300094	.380 ACP	2.75	13.4
Micro Advocate®	3300085	.380 ACP	2.75	13.4
Micro Advocate® with purple/black grips	3300086	.380 ACP	2.75	13.4
Micro DC™ (LG)*	3300096	.380 ACP	2.75	13.4
Micro DC™	3300095	.380 ACP	2.75	13.4

*Includes Crimson Trace Lasergrips®.

A complete presentation of specifications and features begins on page 76.

MICRO 9



THE FEATURES DETAILED ABOVE AND ON THE OPPOSITE PAGE ARE OFFERED IN ADDITION TO THE STANDARD FEATURES FOUND ON EVERY MICRO LISTED ON PAGE 32.

THE MICRO 9™ GROUP of pistols put legendary Kimber dependability into a small 1911-like platform. 9mm power and simple operation make these pistols an ideal choice for many shooters. Twenty-one models are available, providing a selection of features that meet virtually any need. For



2018, the Micro 9 welcomes eight new model options with features found on some of our most popular 1911 families. Collectively, they are among the finest ultra-compact 9mm hammer-fired pistols anyone can carry.



MICRO 9 COVERT

NEW

- KimPro® II gray finished frame and stainless steel slide
- Crimson Trace Lasergrips® in gray urban camo
- Tritium night sights
- Checkered front strap



MICRO 9 TLE

NEW

- KimPro® II black finished stainless steel slide
- KimPro® II black frame
- Green and black G10 Grips
- Tritium night sights
- Checkered front strap



MICRO 9 (LG)

- Low glare matte black slide and frame
- Crimson Trace Lasergrips® in tan
- White dot sights



MICRO 9 WOODLAND NIGHT (LG)

- KimPro® II black finished stainless steel slide
- KimPro® II gray frame
- Crimson Trace Lasergrips® in OD green
- White dot sights

	MODEL	ITEM	CALIBER	BARREL (Inches)	WEIGHT (Ounces)
NEW	Micro 9™ Eclipse	3300189	9mm	3.15	15.6
NEW	Micro 9™ Covert*	3300187	9mm	3.15	15.6
NEW	Micro 9™ TLE	3300191	9mm	3.15	15.6
	Micro 9™ (LG)*	3300176	9mm	3.15	15.6
	Micro 9™ Woodland Night*	3300110	9mm	3.15	15.6

*Includes Crimson Trace Lasergrips®.
A complete presentation of specifications and features begins on page 76.

MICRO 9

Continued



C

MICRO 9 DESERT TAN (LG)

- KimPro® II desert tan finished stainless steel slide
- Matte-black frame
- Crimson Trace Lasergrips® in tan
- White dot sights



C

MICRO 9 STAINLESS RAPTOR

- Patented scaled accents on slide and front strap
- Patented scaled grips
- Ambidextrous thumb safety
- Patented scalloped accents on mainspring housing and slide top
- Tritium night sights



C

MICRO 9 SAPPHIRE

- Mirror-polished slide and small parts
- PVD color finish adds beauty and durability
- Ambidextrous thumb safety
- G-10 grips
- Delicately engraved scroll accents
- Tritium night sights



C

MICRO 9 ROSE GOLD

- Mirror-polished slide and small parts
- PVD color finish adds beauty and durability
- Ambidextrous thumb safety
- G-10 grips
- Delicately engraved scroll accents
- Tritium night sights

MODEL	ITEM	CALIBER	BARREL (Inches)	WEIGHT (Ounces)
Micro 9™ Desert Tan (LG)*	3300168	9mm	3.15	15.6
Micro 9™ Stainless Raptor	3300109	9mm	3.15	15.6
Micro 9™ Sapphire	3300111	9mm	3.15	15.6
Micro 9™ Rose Gold	3300174	9mm	3.15	15.6

*Includes Crimson Trace Lasergrips®.

A complete presentation of specifications and features begins on page 76.



C

MICRO 9 BEL AIR

- Ivory G-10 grips
- Mirror-polished slide and small parts
- Bel Air Blue™ finish on frame
- White dot sights



C

MICRO 9 CRIMSON CARRY

- Two-tone finish
- Rosewood Crimson Trace Lasergrips®
- White dot sights



C

MICRO 9 TWO-TONE

- Two-tone slide and frame finish
- Rosewood grips with Kimber logo
- White dot sights



C

MICRO 9 TWO-TONE (DN)

NEW

- Two-tone slide and frame finish
- Hogue® Wrap Around grips in black
- TRUGLO® TFX™ Pro Day/Night sights with rear cocking ledge and orange front sight ring

MODEL	ITEM	CALIBER	BARREL (Inches)	WEIGHT (Ounces)
Micro 9™ Bel Air	3300110	9mm	3.15	15.6
Micro 9 Crimson Carry*	3300101	9mm	3.15	15.6
Micro 9™ Two-Tone	3300099	9mm	3.15	15.6
NEW Micro 9™ Two-Tone (DN)	3300195	9mm	3.15	15.6

*Includes Crimson Trace Lasergrips®.
A complete presentation of specifications and features begins on page 76.

MICRO 9

Continued



C

MICRO 9 DESERT NIGHT (LG)

- KimPro® II black finished stainless steel slide
- Desert tan frame
- Crimson Trace Lasergrrips® in black
- White dot sights



C

MICRO 9 DESERT NIGHT (DN)

NEW

- KimPro® II black finished stainless steel slide
- Desert tan frame
- Hogue® Wrap Around grips in black
- TRUGLO® TFX™ Pro Day/Night sights with rear cocking ledge and orange front sight ring



C

MICRO 9 STAINLESS

- Stainless steel slide provides additional resistance to the elements
- Non-reflective Satin Silver finish on frame
- White dot sights



C

MICRO 9 STAINLESS (DN)

NEW

- Stainless steel slide provides additional resistance to the elements
- Non-reflective Satin Silver finish on frame
- Hogue® Wrap Around grips in black
- TRUGLO® TFX™ Pro Day/Night sights with rear cocking ledge and orange front sight ring

	MODEL	ITEM	CALIBER	BARREL (Inches)	WEIGHT (Ounces)
	Micro 9 Desert Night (LG)*	3300175	9mm	3.15	15.6
NEW	Micro 9 Desert Night (DN)	3300197	9mm	3.15	15.6
	Micro 9™ Stainless	3300158	9mm	3.15	15.6
NEW	Micro 9™ Stainless (DN)	3300193	9mm	3.15	15.6

*Includes Crimson Trace Lasergrrips®.

A complete presentation of specifications and features begins on page 76.



MICRO 9 CDP (LG)

- KimPro® II gray frame finish
- Carry Melt™ treatment
- Tritium night sights
- Front strap checkering
- Rosewood Crimson Trace Lasergrips®



MICRO 9 CDP (DN)

NEW

- KimPro® II gray frame finish
- Carry Melt™ treatment
- Hogue® Wrap Around grips in black
- TRUGLO® TFX™ Pro Day/Night sights with rear cocking ledge and orange front sight ring
- Front strap checkering



MICRO 9 CDP

- KimPro® II gray frame finish
- Carry Melt™ treatment
- Tritium night sights
- Front strap checkering
- Rosewood grips



MICRO 9 NIGHTFALL (DN)

NEW

- KimPro® II black slide and frame finish
- Hogue® Wrap Around grips in black
- TRUGLO® TFX™ Pro Day/Night sights with rear cocking ledge and orange front sight ring

MODEL	ITEM	CALIBER	BARREL (Inches)	WEIGHT (Ounces)
Micro 9™ CDP (LG)*	3300098	9mm	3.15	15.6
Micro 9™ CDP	3300097	9mm	3.15	15.6
NEW Micro 9™ CDP (DN)	3300196	9mm	3.15	15.6
NEW Micro 9™ Nightfall (DN)	3300194	9mm	3.15	15.6

*Includes Crimson Trace Lasergrips®.

A complete presentation of specifications and features begins on page 76.



MADE IN AMERICA



KIMBER K6s™ REVOLVERS set the bar for concealed carry revolvers by bringing an unmatched level of performance and shootability to concealed carry. Compact and light with the

smallest .357 Magnum cylinder ever offered and a light, no-stack trigger, the K6s blends superior ergonomics and simple operation. Kimber K6s is the revolver of the next generation.

KEY FEATURES AND DETAILS THAT ARE FOUND ON ALL KIMBER K6s REVOLVERS:

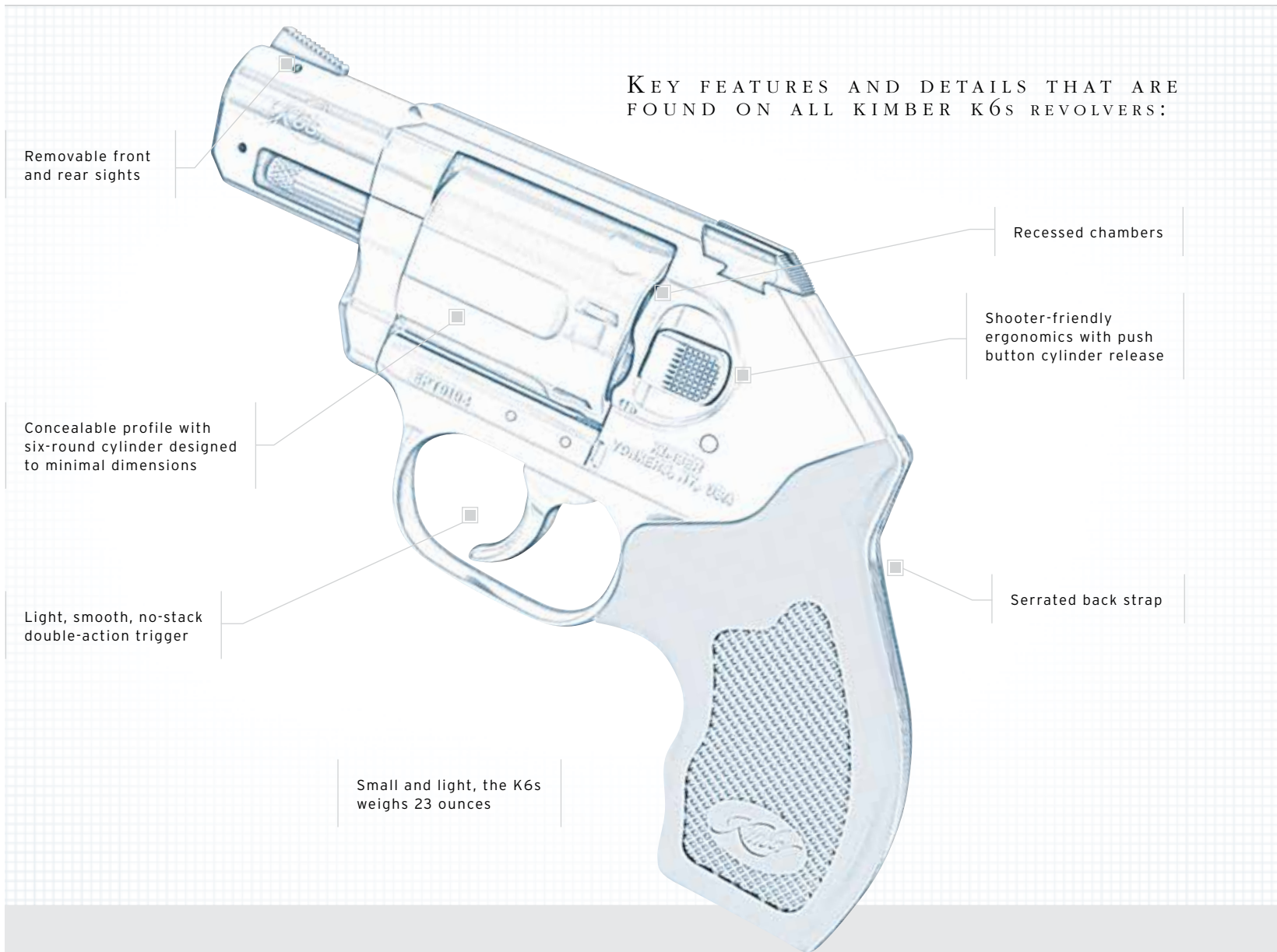

Removable front and rear sights

Recessed chambers

Concealable profile with six-round cylinder designed to minimal dimensions

Shooter-friendly ergonomics with push button cylinder release

Light, smooth, no-stack double-action trigger

Serrated back strap

Small and light, the K6s weighs 23 ounces

THE KIMBER K6s™ IS AMONG THE MOST ACCURATE, shootable and dependable compact revolvers available today. Delivering on size and power, the K6s is the smallest 6-shot revolver on the market today that is specifically designed to fire .357 Magnum defensive

ammunition. Mild recoil and a smooth double-action trigger pull make these revolvers a pleasure to shoot. Kimber engineers pushed the envelope to create the smallest and most comfortable .357 Magnum ever.

K6s REVOLVER

EVOLVING THE REVOLVER.

Kimber

K6s REVOLVERS

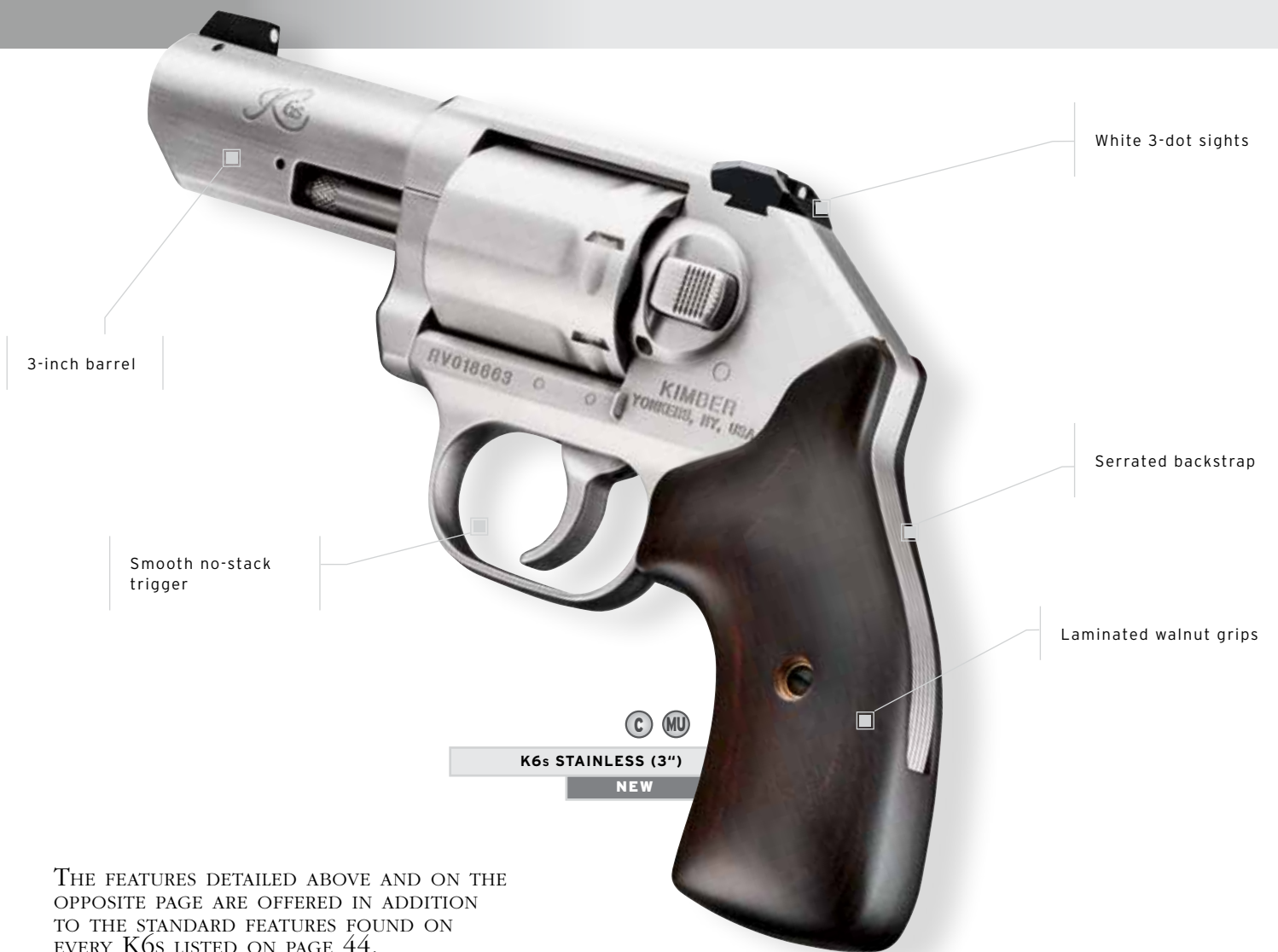

K6s STAINLESS (3")
NEW

THE FEATURES DETAILED ABOVE AND ON THE OPPOSITE PAGE ARE OFFERED IN ADDITION TO THE STANDARD FEATURES FOUND ON EVERY K6s LISTED ON PAGE 44.

With the smallest cylinder capable of holding 6 rounds of .357 Magnum (also compatible with .38 Special) offered today, K6s™ compact revolvers are well-suited for backup, concealed carry and home defense. The small frame, 2- and 3-inch barrel and 1.39-inch diameter cylinders are machined from the finest stainless steel for superior integrity, strength and resistance to moisture. The K6s offers important design features, including an advanced double-action trigger with a short, smooth, no-stack trigger that creates confidence while ensuring accuracy. The hammer is internal and edges are



rounded and blended to prevent hang up when the revolver is removed from concealment. 2018 brings the addition of the first 3-inch barrel for the K6s family, the K6s Stainless (3"), as well as two 2-inch barreled models, the classic K6s CDP and the sleek K6s DC. For those who require a small package with mild recoil, K6s provides the power needed for concealed carry, home protection and many other applications. Best of all, they offer unequalled Kimber quality, dependability and performance.



C NEW

K6s DC

- Black DLC over brushed stainless finish
- Tritium night sights
- Black and gray G-10 grips



C NEW

K6s CDP

- Two-tone black DLC over brushed stainless frame.
- Brushed stainless barrel
- Laminated rosewood grips
- Tritium night sights



C

K6s DCR (DELUXE CARRY REVOLVER)

- Smooth Satin finish
- Red fiber optic front sight and black rear sight
- Checkered Millenium rosewood grips



C

K6s STAINLESS (LG)

- Low-glare brushed stainless finish
- Gray laminate and rubber Crimson Trace Master Series™ Lasergrips®
- White 3-dot sights



C

K6s STAINLESS

- Low-glare brushed stainless finish
- White 3-dot sights
- Black rubber grips



C

K6s STAINLESS (NS)

- 3-dot tritium night sights
- Black rubber grips

	MODEL	ITEM	CALIBER	BARREL (Inches)	WEIGHT (Ounces)
NEW	K6s™ CDP	3400013	.357 Mag.	2	23
NEW	K6s™ DC	3400012	.357 Mag.	2	23
NEW	K6s™ Stainless (3")	3400011	.357 Mag.	3	25.1
	K6s™ Stainless	3400010	.357 Mag.	2	23
	K6s™ Stainless (LG)*	3400003	.357 Mag.	2	23
	K6s™ Stainless (NS)	3400004	.357 Mag.	2	23
	K6s™ DCR	3400009	.357 Mag.	2	23

*Includes Crimson Trace Lasergrips®.
A complete presentation of specifications and features begins on page 76.





A photograph of a rifle with a scope resting on a log in a field of tall grass at sunset. The rifle is positioned horizontally, with the scope pointing towards the right. The background shows a landscape with mountains and trees under a warm, golden sky. The foreground is filled with tall, dry grasses.

RIFLES

IT'S NOT JUST HUNTING.

RIFLE SELECTION GUIDE

CUSTOM DETAILS AND FEATURES FOUND STANDARD ON ALL KIMBER RIFLES:

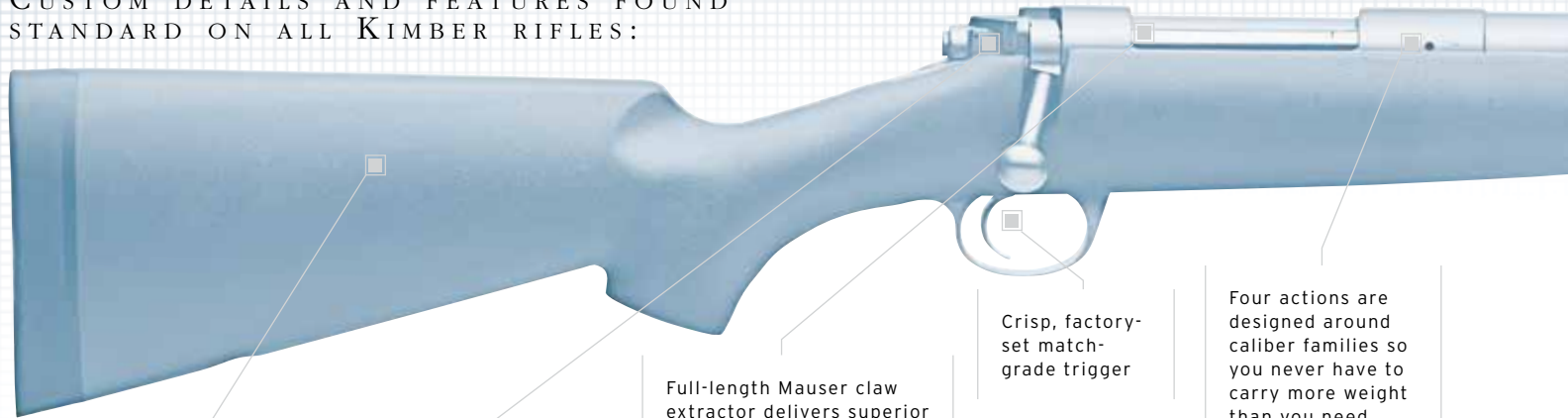

Straight comb stock design projects recoil into the shoulder, not up and over or into the cheekbone

Positive 3-position wing safety with serrated lever is the finest ever designed

Full-length Mauser claw extractor delivers superior controlled round feeding and extraction

Crisp, factory-set match-grade trigger

Four actions are designed around caliber families so you never have to carry more weight than you need

ON THE FOLLOWING PAGES YOU WILL FIND MODEL DETAILS UNIQUE TO EACH MODEL IN ADDITION TO THE FEATURES OUTLINED ON THIS PAGE.

THE KIMBER BRAND GOES BACK TO 1979, and its rifles have been favored by discriminating hunters and shooters ever since. Kimber offers a wide selection of classic sporting, hard-core hunting, unique varmint and no-compromise tactical rifles. Each

is based on an action size designed with minimal dimensions for the cartridge's family. Accuracy is the best measure of rifle quality, and reliability follows. Each rifle is guaranteed under the Kimber SUB MOA Accuracy Standard.



84M
.308 WIN.

84L
.30-06 SPRG.

8400 SM
.300 WSM

8400 LM
.300 WIN. MAG.

ACTION 84M Action Length 7.63" Action Diameter 1.14" Rifle Weight 4lbs., 13oz.	CALIBERS .204 Ruger .223 Rem. .22-250 Rem. .243 Win. .257 Roberts 6.5 Creedmoor 7mm-08 Rem. .300 Blackout .308 Win.
ACTION 84L Action Length 8.16" Action Diameter 1.14" Rifle Weight 5lbs., 5oz.	CALIBERS .25-06 Rem. .270 Win. .280 Ack. Imp. .30-06 Sprg.
ACTION 8400 SM Action Length 8.4" Action Diameter 1.36" Rifle Weight 6lbs., 3oz.	CALIBERS 6.5 Creedmoor .308 Win. .270 WSM .300 WSM
ACTION 8400 LM Action Length 9.24" Action Diameter 1.36" Rifle Weight 6lbs., 13oz.	CALIBERS 7mm Rem. Mag. .300 Win. Mag. .338 Win. Mag. .375 H&H Mag. .416 Rem. Mag. .458 Lott

*Weight given for the lightest rifle and caliber combination based on this action. See page 77 for complete specifications.

KIMBER RIFLES OFFER A COMBINATION OF FEATURES that set them apart from other production brands. Barrels, chambers and triggers are crafted with critical match grade dimensions for unmatched accuracy. All of Kimber's rifles are controlled round feed. Pillar and glass bedding add strength and ensure that nothing shifts under recoil or during rough use. Walnut stocks are finished and checkered by hand, and reinforced carbon fiber stocks are the

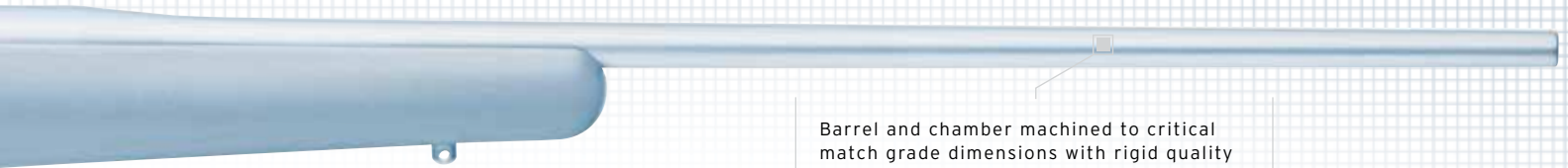

Barrel and chamber machined to critical match grade dimensions with rigid quality control ensures exceptional accuracy

Pillar and/or glass bedding provides strength and accuracy

Each proportioned action gives near perfect balance for fast, positive aiming

*This dimension is 2.40 inches in actions chambered for .204 Ruger and .223 Rem.

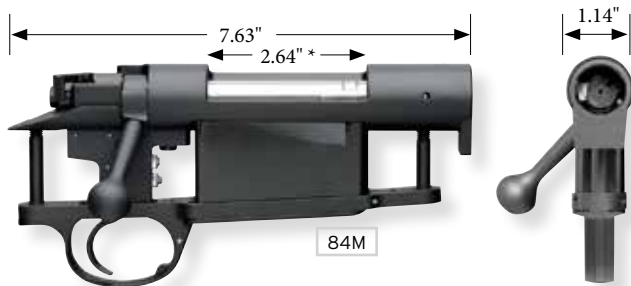

84M ACTION FEATURES

- The 84M (Medium) action has minimal dimensions for cartridges ranging from .204 Ruger to .308 Win.
- As part of the lightest production rifles available today, this action is built for short bolt travel and allows for faster operation
- Barrel is an optimal length for the flattest trajectory and superior accuracy
- Magazine capacity is 3-6 rounds, depending on caliber chambering
- Available in 19 models and 9 calibers

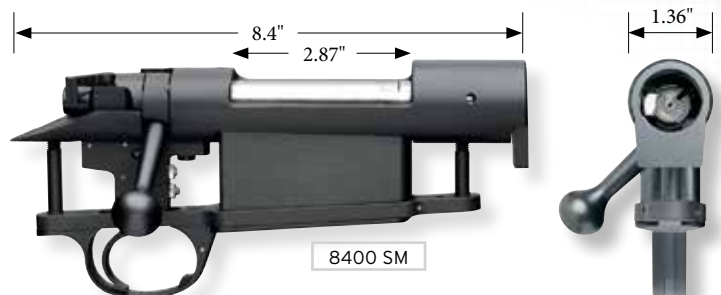

8400 SM ACTION FEATURES

- The 8400 SM (Short Magnum) action sized for Short Magnum cartridges has a greater diameter but remains as short as possible to reduce weight and ensure proper balance
- Barrel is the proper length for maximum velocity and flat trajectory
- Ideal for almost any North American big game
- Magazine capacity is 3-4 rounds, depending on caliber chambering
- Available in 8 models and 4 calibers



84L ACTION FEATURES

- The 84L (Long) action has the minimal diameter of the 84M but is slightly longer to fit America's most popular and powerful hunting cartridges, such as the .270 Winchester and .30-06 Springfield
- The lightest rifle in its class
- Barrel is an optimal length for the flattest trajectory and superior accuracy
- Magazine capacity is 3-5 rounds, depending on caliber chambering
- Available in 9 models and 4 calibers

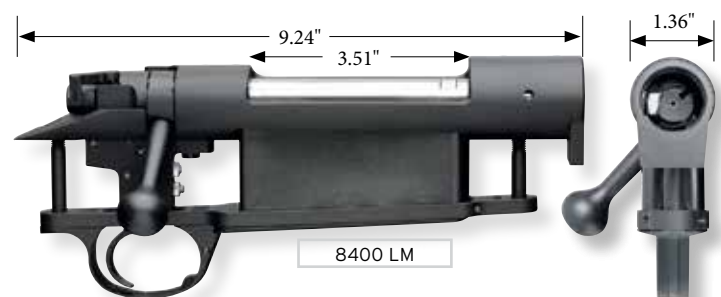

8400 LM ACTION FEATURES

- The 8400 LM (Long Magnum) action has the additional length required by some of the world's most powerful cartridges, such as .300 Winchester Magnum and .458 Lott
- Suitable for hunting both large and dangerous game
- Barrel is the proper length for maximum velocity and balance
- Magazine capacity is 3-5 rounds, depending on caliber chambering
- Available in 8 models and 6 calibers

finest worn by any production rifle. Descriptions of each rifle family are presented throughout the following pages, and more than 2,000 Kimber Master Dealers across America stand ready to assist in the selection of a model that will meet your needs. To locate your nearest Kimber Master Dealer, find complete information on each model or view product videos, please visit kimberamerica.com.

TRADITIONAL

CLASSIC SELECT GRADE



SUPERAMERICA



KIMBER'S TRADITIONAL BIG-GAME RIFLES offer an unequalled combination of features, elegance and performance. All actions have minimal dimensions for the cartridges they chamber, permitting a trim overall profile that reduces weight by as much as two pounds. All traditional rifles include critical design features that ensure performance and dependability. Stocks are born of fine walnut and then checkered and finished by hand. The elegant pillar and glass bedded sporter stock is carefully shaped and



dimensioned from fine walnut for both recoil control and quick pointability. This properly dimensioned classic stock and recoil-absorbing 1-inch Pachmayr Decelerator® recoil pad diminish felt recoil. The Kimber-designed straight comb stock slides back into the shoulder, not up into the cheekbone. A sculpted steel bottom metal has a floorplate release inside the trigger bow that prevents accidental opening. Just as hunting is more than a sport, a Kimber traditional rifle is more than just a rifle.



THE FEATURES DETAILED ON THESE PAGES ARE OFFERED IN ADDITION TO THE STANDARD FEATURES FOUND ON EVERY RIFLE LISTED ON PAGE 50.



MODEL	ITEM	CALIBER
Classic Select Grade™	3000624	.223 Rem.
Classic Select Grade™	3000670	.243 Win.
Classic Select Grade™	3000709	.257 Rob.
Classic Select Grade™	3000668	7mm-08 Rem.
Classic Select Grade™	3000667	.308 Win.
Classic Select Grade™	3000732	.25-06 Rem.
Classic Select Grade™	3000733	.270 Win.
Classic Select Grade™	3000751	.280 Ack. Imp.

MODEL	ITEM	CALIBER
Classic Select Grade™	3000734	.30-06 Sprg.
Classic Select Grade™	3000676	.270 WSM
Classic Select Grade™	3000675	.300 WSM
Classic Select Grade™	3000625	7mm Rem. Mag.
Classic Select Grade™	3000703	.300 Win. Mag.
Classic Select Grade™	3000702	.338 Win. Mag.
SuperAmerica™	3000620	.308 Win.

A complete presentation of specifications and features begins on page 77.



HUNTER

NEW

HUNTER (BLACK)



Reinforced synthetic stock

Full-length Mauser claw extractor delivers superior controlled round feeding and extraction

Detachable magazine for quick, easy loading and unloading

Weather-resistant stainless steel action

HUNTER



- Reinforced synthetic stock
- Detachable magazine for quick, easy loading and unloading
- Weather-resistant stainless steel barrel and action
- Controlled round feed



	MODEL	ITEM	CALIBER
NEW	Hunter (Black)	3000847	.243 Win.
NEW	Hunter (Black)	3000850	.308 Win.
NEW	Hunter (Black)	3000851	6.5 Creedmoor
NEW	Hunter (Black)	3000852	.270 Win.
NEW	Hunter (Black)	3000854	.30-06 Sprg.
	Hunter	3000791	.243 Win.
	Hunter	3000792	.257 Roberts
	Hunter	3000790	7mm-08 Rem.
	Hunter	3000789	.308 Win.
	Hunter	3000793	6.5 Creedmoor
	Hunter	3000795	.270 Win.
	Hunter	3000796	.280 Ack. Imp.
	Hunter	3000794	.30-06 Sprg.

	MODEL	ITEM	CALIBER
NEW	Hunter (Realtree Edge)	3000839	.243 Win.
NEW	Hunter (Realtree Edge)	3000842	.308 Win.
NEW	Hunter (Realtree Edge)	3000843	6.5 Creedmoor
NEW	Hunter (Realtree Edge)	3000844	.270 Win.
NEW	Hunter (Realtree Edge)	3000846	.30-06 Sprg.
NEW	Hunter (Boot Campaign)	3700441	.243 Win.
NEW	Hunter (Boot Campaign)	3700444	7mm-08 Rem.
NEW	Hunter (Boot Campaign)	3700443	.308 Win.
NEW	Hunter (Boot Campaign)	3700442	.270 Win.
NEW	Hunter (Boot Campaign)	3700445	.280 Ack. Imp.
NEW	Hunter (Boot Campaign)	3700439	.25-06 Rem.
NEW	Hunter (Boot Campaign)	3700440	.30-06 Sprg.

A complete presentation of specifications and features begins on page 77.

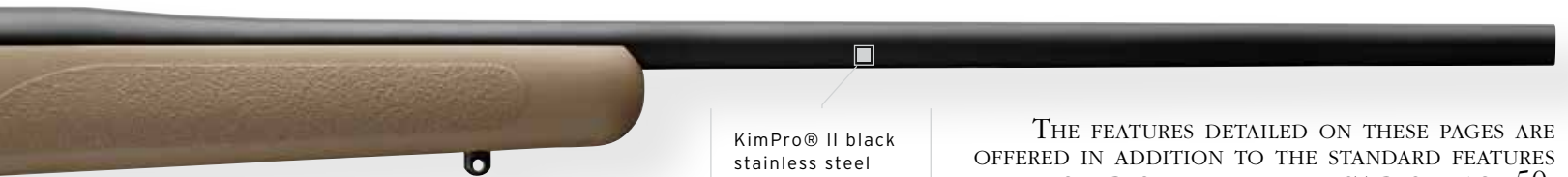

KimPro® II black stainless steel barrel finish

THE FEATURES DETAILED ON THESE PAGES ARE OFFERED IN ADDITION TO THE STANDARD FEATURES FOUND ON EVERY RIFLE LISTED ON PAGE 50.

NEW
HUNTER (BOOT CAMPAIGN)



BOOT CAMPAIGN

Boot Campaign provides programs and initiatives to help veterans and military families transition from military life to civilian life. Kimber is a proud sponsor of Boot Campaign.

- Reinforced synthetic stock in Kryptek Highlander™
- Portion of the proceeds go to the Boot Campaign
- Detachable magazine for quick, easy loading and unloading
- Weather-resistant stainless steel action with KimPro® II black finish
- Controlled round feed

NEW
HUNTER (REALTREE EDGE)



- Reinforced synthetic stock in Realtree Edge™
- Detachable magazine for quick, easy loading and unloading
- Weather-resistant stainless steel barrel and action with KimPro® II black finish
- Controlled round feed



THE KIMBER HUNTER offers our legendary accuracy and performance paired with a patent-pending synthetic stock and removeable box magazine. Three new models join the original Hunter rifle, with barrel and receiver now being available in low-profile, matte-black KimPro® II finish, and stocks available in Realtree Edge™ pattern and Kryptek Highlander™. Paired with a barrel and action in finish that controls light reflection

and an incredibly popular pattern, the Hunter (Realtree Edge™) is a winning combination for our Northeastern hunters. Our Boot Campaign rifle carries the Boot Campaign logo engraved on the barrel, and a portion of the proceeds go directly to this charity that works to help veterans across the United States. Chambered in a wide selection of calibers, this rifle family offers the ideal combinations for any type of game.

MOUNTAIN

SUBALPINE



Reinforced carbon fiber stock in soft touch Gore™ Optifade™ Subalpine

Full-length Mauser claw extractor delivers superior controlled round feeding and extraction

Skeletonized extractor

MONTANA



Reinforced carbon fiber stock in Moss Green

Full-length Mauser claw extractor delivers superior controlled round feeding and extraction



MODEL	ITEM	CALIBER
Subalpine™	3000821	.308 Win.
Subalpine™	3000820	.280 Ack. Imp.
Subalpine™	3000819	.30-06 Sprg.
Subalpine™	3000823	.300 WSM
Subalpine™	3000822	.300 Win. Mag.
Montana™	3000810	.223 Rem.
Montana™	3000800	.22-250 Rem.
Montana™	3000803	.243 Win.
Montana™	3000809	.257 Roberts
Montana™	3000804	7mm-08 Rem.

MODEL	ITEM	CALIBER
Montana™	3000802	.308 Win.
Montana™	3000799	6.5 Creedmoor
Montana™	3000813	.25-06 Rem.
Montana™	3000811	.270 Win.
Montana™	3000814	.280 Ack. Imp.
Montana™	3000812	.30-06 Sprg.
Montana™	3000806	.270 WSM
Montana™	3000805	.300 WSM
Montana™	3000807	.300 Win. Mag.
Montana™*	3000687	.338 Win. Mag.

*Barrel not threaded

A complete presentation of specifications and features begins on page 77.

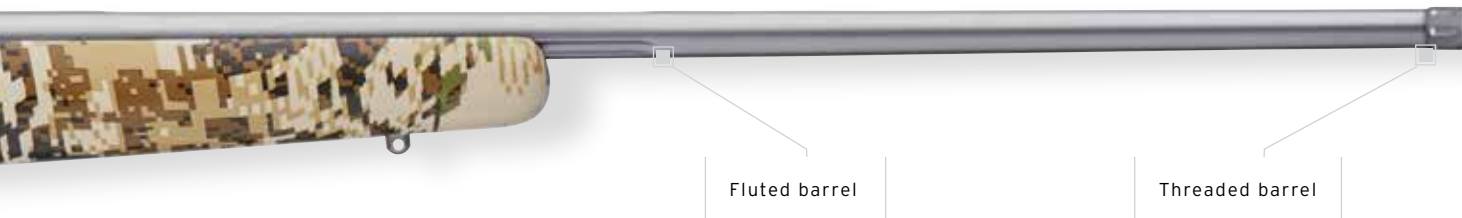

THE FEATURES DETAILED ON THESE PAGES ARE OFFERED IN ADDITION TO THE STANDARD FEATURES FOUND ON EVERY RIFLE LISTED ON PAGE 50.

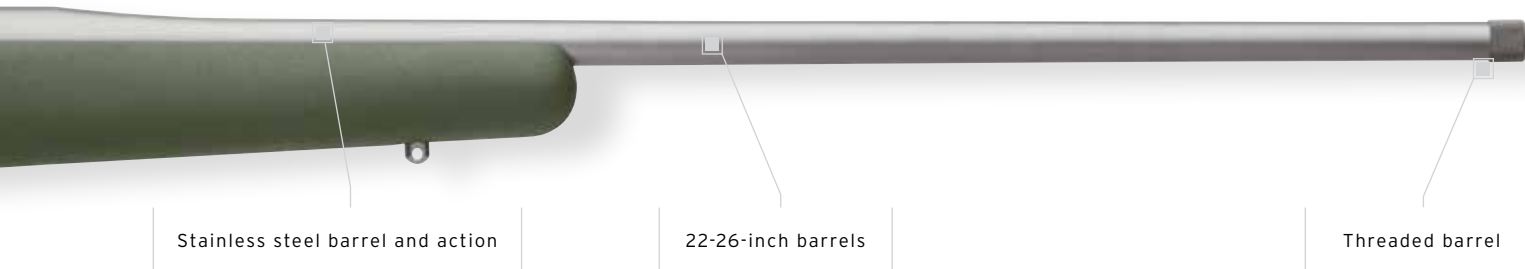

A TRUE MOUNTAIN RIFLE must be light and accurate—hard-core hunters understand. Montana™, Adirondack™, Mountain Ascent™, and Subalpine models are the lightest production big-game rifles ever offered, delivering legendary Kimber accuracy yet still weighing as little as 4 pounds, 13 ounces. Reinforced carbon fiber stocks add strength, and stainless steel shrugs the elements. All Kimber Mountain rifles offer a threaded barrel for optional use of muzzle brakes and suppressors. Montana and Subalpine rifles combine all the best Kimber features in a lightweight, stainless steel and reinforced carbon fiber package

that helps ensure performance. Adirondack and Mountain Ascent models go even further. Featuring a combination of spiral fluted bolt body and hollow bolt knob, the Adirondack is compact for fast maneuvering. The Mountain Ascent has additional custom features, including a fluted barrel and muzzle brake to reduce felt recoil. Both wear Gore™ Optifade™ soft-touch stock treatments that blend into any environment and ship with matte black ring mounts. Optifade ring mounts and muzzle brake accessories are available separately. These rifles have no equal.

MOUNTAIN

Continued

MOUNTAIN ASCENT



Reinforced carbon fiber stock in soft touch Gore™ Optifade™ Open Country

Fluted bolt handle and hollow bolt knob

Full-length Mauser claw extractor delivers superior controlled round feeding and extraction

Fluted bolt

MOUNTAIN ASCENT (MOSS GREEN)



Reinforced carbon fiber stock in Moss Green

Fluted bolt handle and hollow bolt knob

Full-length Mauser claw extractor delivers superior controlled round feeding and extraction

Fluted bolt

ADIRONDACK



Reinforced carbon fiber stock in soft touch Gore™ Optifade™ Elevated II

Hollow bolt knob

Full-length Mauser claw extractor delivers superior controlled round feeding and extraction

Fluted bolt

Stainless steel barrel and action

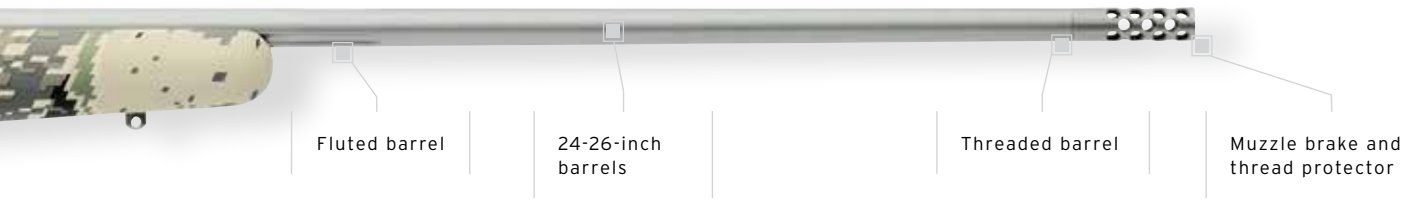

THE FEATURES DETAILED ON THESE PAGES ARE OFFERED IN ADDITION TO THE STANDARD FEATURES FOUND ON EVERY RIFLE LISTED ON PAGE 50.

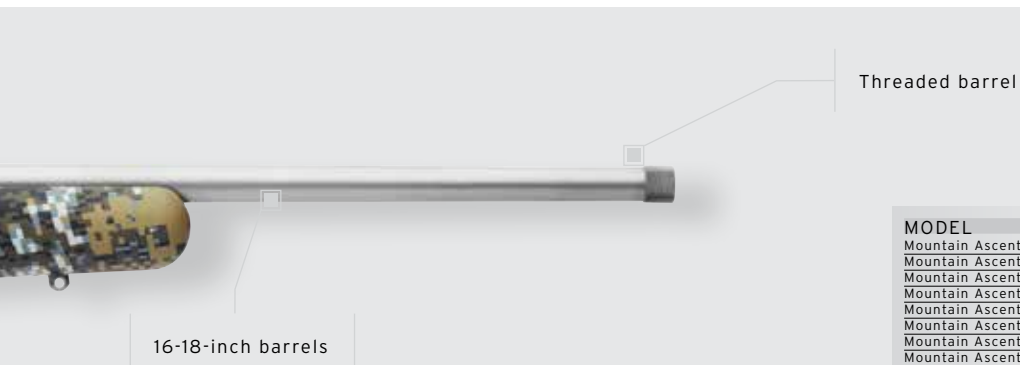

MODEL	ITEM	CALIBER
Mountain Ascent™	3000763	.308 Win.
Mountain Ascent™	3000765	.270 Win.
Mountain Ascent™	3000764	.280 Ack. Imp
Mountain Ascent™	3000766	.30-06 Sprg.
Mountain Ascent™	3000775	.300 WSM
Mountain Ascent™	3000776	.270 WSM
Mountain Ascent™	3000777	.300 Win. Mag.
Mountain Ascent™	3000778	7mm Rem. Mag.
Mountain Ascent™	3000798	7mm-08 Rem.
Mountain Ascent™	3000797	6.5 Creedmoor
Mountain Ascent™ (Moss Green)	3000824	.300 Win. Mag.
Mountain Ascent™ (Moss Green)	3000825	.280 Ack. Imp.
Mountain Ascent™ (Moss Green)	3000826	.308 Win.
Mountain Ascent™ (Moss Green)	3000827	.30-06 Sprg.
Adirondack™	3000815	7mm-08 Rem.
Adirondack™	3000816	.308 Win.
Adirondack™	3000818	.300 AAC Blackout
Adirondack™	3000817	6.5 Creedmoor



A complete presentation of specifications and features begins on page 77.

DANGEROUS GAME

CAPRIVI



AA-grade
French walnut

Pancake cheek piece

Full-length Mauser claw
extractor delivers superior
controlled round feeding
and extraction

Twin cross bolts

TALKEETNA



Reinforced carbon
fiber stock

Full-length Mauser claw
extractor delivers superior
controlled round feeding
and extraction

Stainless steel
barrel and action



MODEL	ITEM	CALIBER
Caprivi™	3000692	.375 H&H Mag.
Caprivi™	3000728	.416 Rem. Mag.
Caprivi™	3000705	.458 Lott
Talkeetna™	3000706	.375 H&H Mag.

A complete presentation of specifications and features begins on page 77.

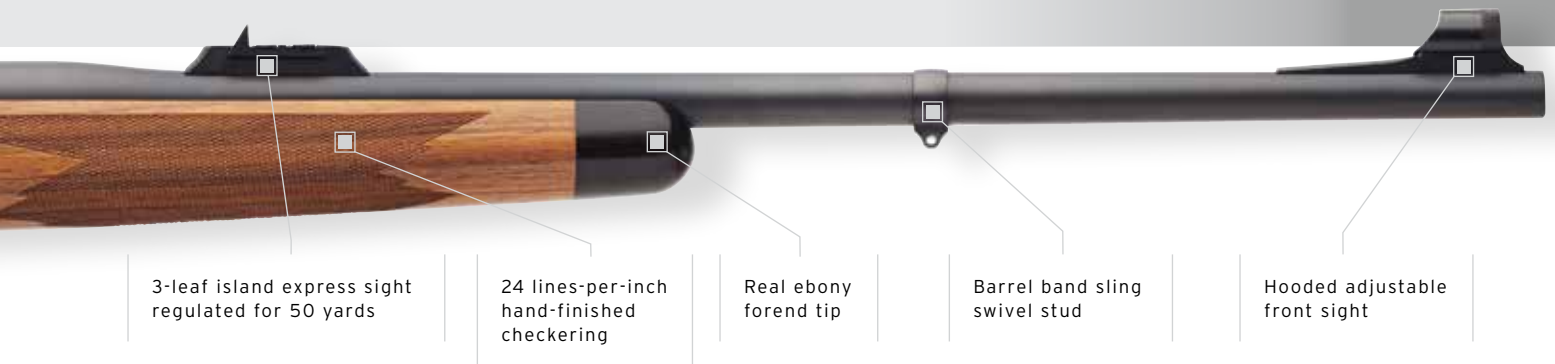

3-leaf island express sight regulated for 50 yards

24 lines-per-inch hand-finished checkering

Real ebony forend tip

Barrel band sling swivel stud

Hooded adjustable front sight

THE FEATURES DETAILED ON THESE PAGES ARE OFFERED IN ADDITION TO THE STANDARD FEATURES FOUND ON EVERY RIFLE LISTED ON PAGE 50.

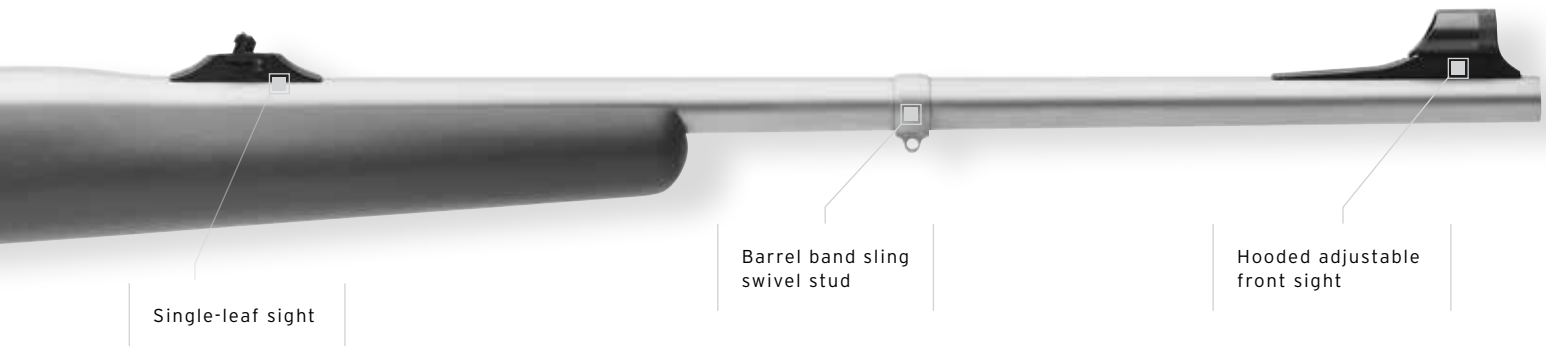

Single-leaf sight

Barrel band sling swivel stud

Hooded adjustable front sight



KIMBER DANGEROUS GAME rifles deliver unwavering reliability and charge-stopping energy. Equally important, they have critical features absent from other production rifles in heavy calibers. The Caprivi™ is designed for Africa and the Talkeetna™ is ready for the unpredictable weather of Alaska — places where Kimber quality takes on a whole new level of importance. The Model 8400 Caprivi has a AA-grade French walnut stock with a hand-rubbed oil finish, 24 lines-per-inch wrap-around checkering, ebony forend tip and traditional pancake cheek piece. It also has a 3-leaf island express sight with the fixed leaf regulated for 50 yards. The Talkeetna has a stainless steel barreled action and reinforced carbon fiber

stock — the finest ever offered in a production dangerous game rifle — and is mounted with a single-leaf express sight. Both the Caprivi and Talkeetna have a full-length Mauser claw extractor for true controlled-round feeding and extraction, plus a 3-position safety that is positive, quiet and fast. A barrel band sling swivel stud will not contact the forward hand during recoil. Front sights on both of these rifles are hooded and adjustable for elevation, and both folders remain green for custom regulation. These are the best production dangerous game rifles available, and the game they were designed to hunt deserve nothing less.

OPEN RANGE

NEW

OPEN COUNTRY (GRANITE)

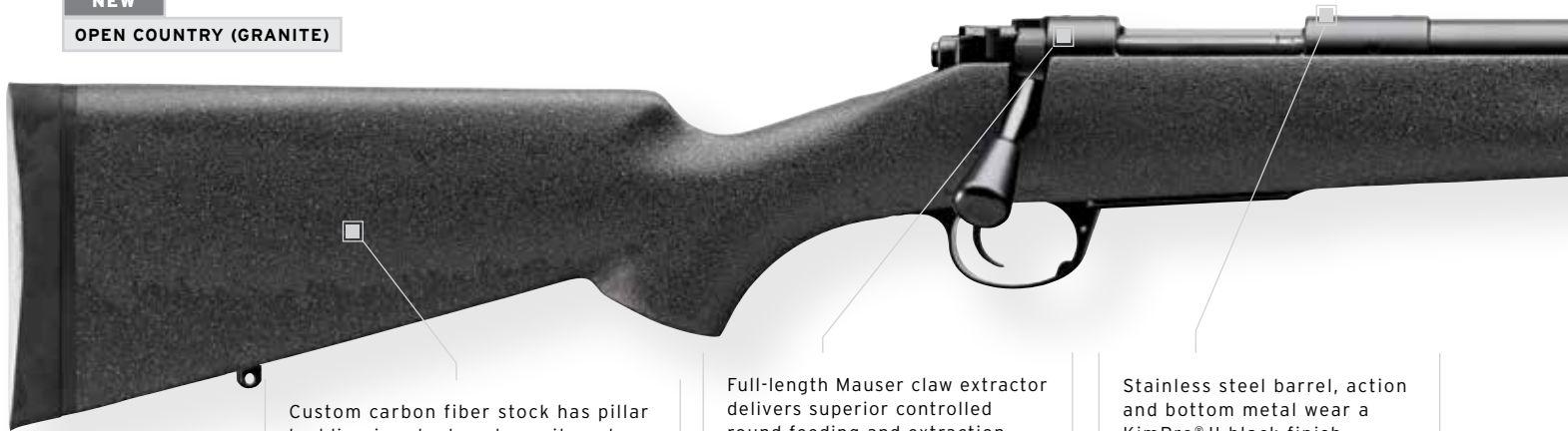

Custom carbon fiber stock has pillar bedding in a textured granite color

Full-length Mauser claw extractor delivers superior controlled round feeding and extraction

Stainless steel barrel, action and bottom metal wear a KimPro® II black finish

OPEN COUNTRY



Custom carbon fiber stock has pillar bedding and Gore™ Optifade™ Open Country pattern

Full-length Mauser claw extractor delivers superior controlled round feeding and extraction

Stainless steel barrel, action and bottom metal wear a KimPro® II gray finish

LONGMASTER CLASSIC



- A-Grade walnut stock
- Match grade chamber
- Sculpted steel bottom metal with floorplate release inside the trigger guard
- Pillar and glass bedding
- Stainless steel fluted barrel
- Controlled round feed



	MODEL	ITEM	CALIBER
	Open Country	3000782	6.5 Creedmoor
	Open Country	3000862	.308 Win.
NEW	Open Country (Granite)	3000861	6.5 Creedmoor
NEW	Open Country (Granite)	3000860	.308 Win.
	LongMaster® Classic™	3000641	.223 Rem.
	LongMaster® Classic™	3000410	.308 Win.

A complete presentation of specifications and features begins on page 77.

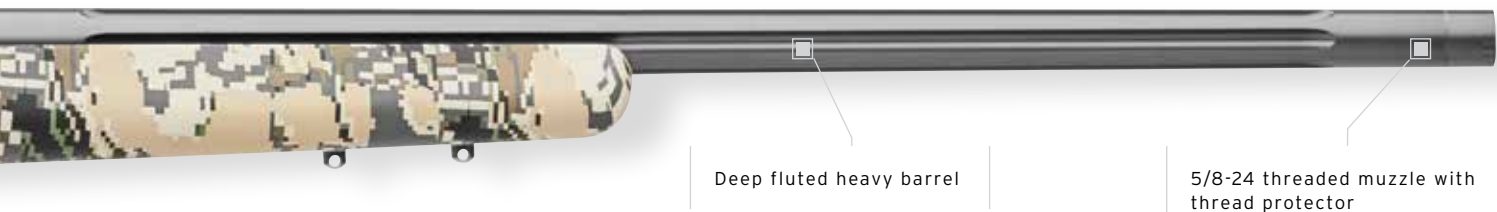
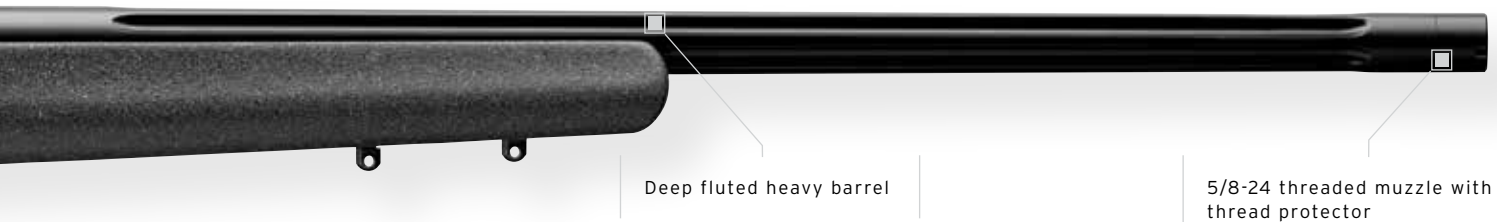

THE FEATURES DETAILED ON THESE PAGES ARE OFFERED IN ADDITION TO THE STANDARD FEATURES FOUND ON EVERY RIFLE LISTED ON PAGE 50.



OUR OPEN RANGE rifles come with fluted, heavy barrels, in both wood and carbon fiber stocks, giving you all the advantages a hunter would demand for accuracy in that environment. The Longmaster Classic keeps with tradition and offers the heavy, contoured barrel in a beautiful A-grade walnut stock. Open Country delivers tack-driving performance in a manageable long-range rifle. The Open Country's hand laid carbon graphite stock lends strength without excessive weight. The finish on the new Open Country (Granite) stock gives a slight

texture to help weld grip and give confidence in feel no matter the conditions. For our hunters interested in a patterned rifle, the Open Country stock has a soft touch finish in Gore™ Optifade™ Open Country. Threaded barrels give shooters the option to add accessories of their choice. Now available in .308 Win. and 6.5 Creedmoor in both models, the Open Country rifle is an ideal choice for those long-distance, open-range hunts.

VARMINT

VARMINT



A-grade walnut sporter stock

Sculpted steel bottom metal with floorplate release inside the trigger guard

Full-length Mauser claw extractor delivers superior controlled round feeding and extraction

Match grade chamber

PRO VARMINT



- Laminated stock
- Beavertail forend
- Stainless steel barreled action
- Controlled round feed

THE FEATURES DETAILED ON THESE PAGES ARE OFFERED IN ADDITION TO THE STANDARD FEATURES FOUND ON EVERY RIFLE LISTED ON PAGE 50.



MODEL	ITEM	CALIBER
Varmint™	3000650	.204 Ruger
Varmint™	3000601	.22-250 Rem.
Pro Varmint™	3000671	.204 Ruger
Pro Varmint™	3000638	.223 Rem.
Pro Varmint™	3000639	.22-250 Rem.
SVT™	3000647	.223 Rem.
LongMaster® VT™	3000409	.22-250 Rem.

A complete presentation of specifications and features begins on page 77.



LONGMASTER VT

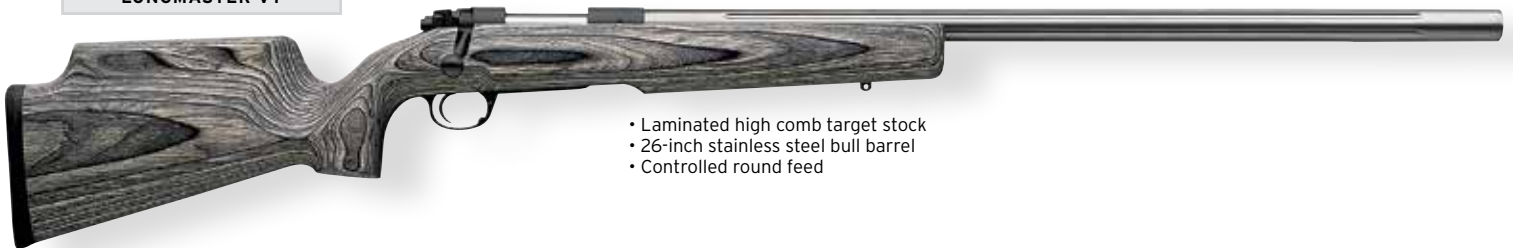

- Laminated high comb target stock
- 26-inch stainless steel bull barrel
- Controlled round feed

SVT



- Laminated high comb target stock
- 18.25-inch stainless steel bull barrel
- Controlled round feed



VARMINT AND HEAVY BARRELED RIFLES MUST DELIVER pinpoint accuracy with absolute consistency regardless of field conditions. This group of Kimber rifles ensures this level of performance through a combination of match grade components, careful bedding and proper design. Light to heavy, there is a Kimber varmint rifle for any type of predator hunting or varmint shooting. Varmint™ and Pro Varmint™ models are perfect for hunters who move and call. SVT™ (Short Varmint/Target) and LongMaster® VT™ (Varmint Target) are best suited

for a day overlooking a prairie dog town. The Varmint configuration has a heavy target stock shaped from ultra-stable laminated wood blanks. A high comb and deep pistol grip with palm swell is well-suited for shooting prone or from a bench. All models have sculpted steel bottom metal with a floorplate release inside the trigger guard, which is both functional and elegant. Four specialized models cover it all, from predator calling to working from a stand.

TACTICAL

NEW

ADVANCED TACTICAL SOC II (FDE)



Left folding stock allows for bolt cycling while folded and has 4-point adjustable comb

Full-length Mauser claw extractor delivers superior controlled round feeding and extraction

Ships with 5-round magazine

Extended bolt handle with oversized knob

PATROL TACTICAL



- Fluted barrel
- Reinforced carbon fiber stock with grooved forearm and squared forend
- Two forend swivel studs
- Controlled round feed

LPT



- Model 84M action
- 22-inch fluted barrel
- Laminated stock
- Two forend swivel studs
- Controlled round feed

THE FEATURES DETAILED ON THESE PAGES ARE OFFERED IN ADDITION TO THE STANDARD FEATURES FOUND ON EVERY RIFLE LISTED ON PAGE 50.



	MODEL	ITEM	CALIBER
	Advanced Tactical™ SOC II (SG)	3000858	.308 Win.
NEW	Advanced Tactical™ SOC II (SG)	3000857	6.5 Creedmoor
NEW	Advanced Tactical™ SOC II (FDE)	3000856	.308 Win.
NEW	Advanced Tactical™ SOC II (FDE)	3000855	6.5 Creedmoor
NEW	Advanced Tactical™ SRC II (FDE)	3000859	.308 Win.



	MODEL	ITEM	CALIBER
	Patrol Tactical™	3000772	.308 Win.
	Patrol Tactical™	3000771	.300 Win. Mag.
	LPT™	3000611	.223 Rem.
	LPT™	3000729	.308 Win.

A complete presentation of specifications and features begins on page 77.



ADVANCED TACTICAL SOC II (SG)

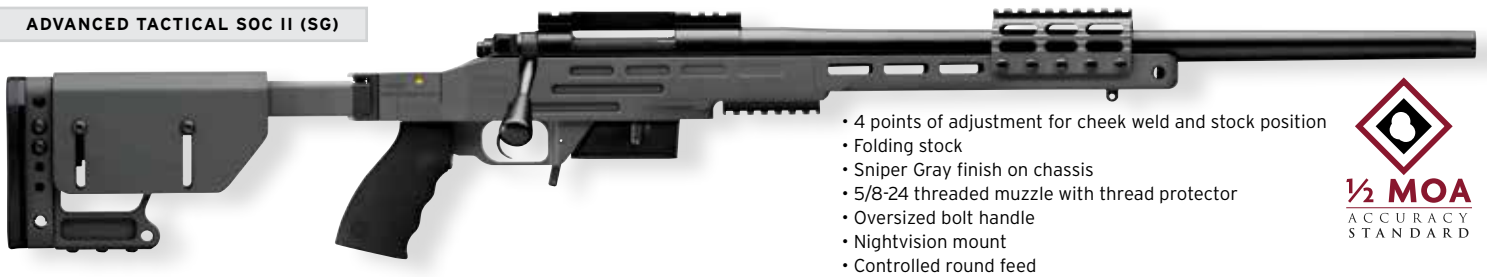

ADVANCED TACTICAL SRC II



KIMBER BUILDS NO-COMPROMISE tactical rifles to help meet the requirements of military or law enforcement professionals. In these arenas, the need for accuracy and dependability takes on a new meaning. Kimber tactical rifles have match grade barrels, chambers and triggers for the highest degree of accuracy. Each action features a full-length Mauser claw extractor for the superior dependability of controlled-round feeding plus an extended bolt handle with an oversized bolt knob for positive operation regardless of field conditions. The Model 84M LPT™ (Light Police Tactical) is a light urban tactical rifle offering the advantages of short-barreled portability. The Patrol Tactical™ is a tough, full-sized model with a reinforced carbon fiber stock configured for optimum stability from any position. Advanced

Tactical SOC II rifles received a complete update to their chassis. Now shipping with a McRees Precision custom stock for Kimber in two color options—FDE and Sniper Gray—they feature a left folding stock that allows for bolt manipulation while folded, a 4-point adjustable cheek weld for a versatile level of personalization, M-LOK® slots, tripod mount, and stock pack. The match grade dimensions of the Advanced Tactical™ SOC II and Advanced Tactical SRC II barrels are verified with an air gauge to ensure accuracy, and every rifle is built by hand, guaranteeing each to have fired a 3-shot group measuring .5 MOA prior to shipping. From a short, light configuration for fast deployment to heavier models with advanced features for long-range precision, Kimber tactical rifles are ready for anything.



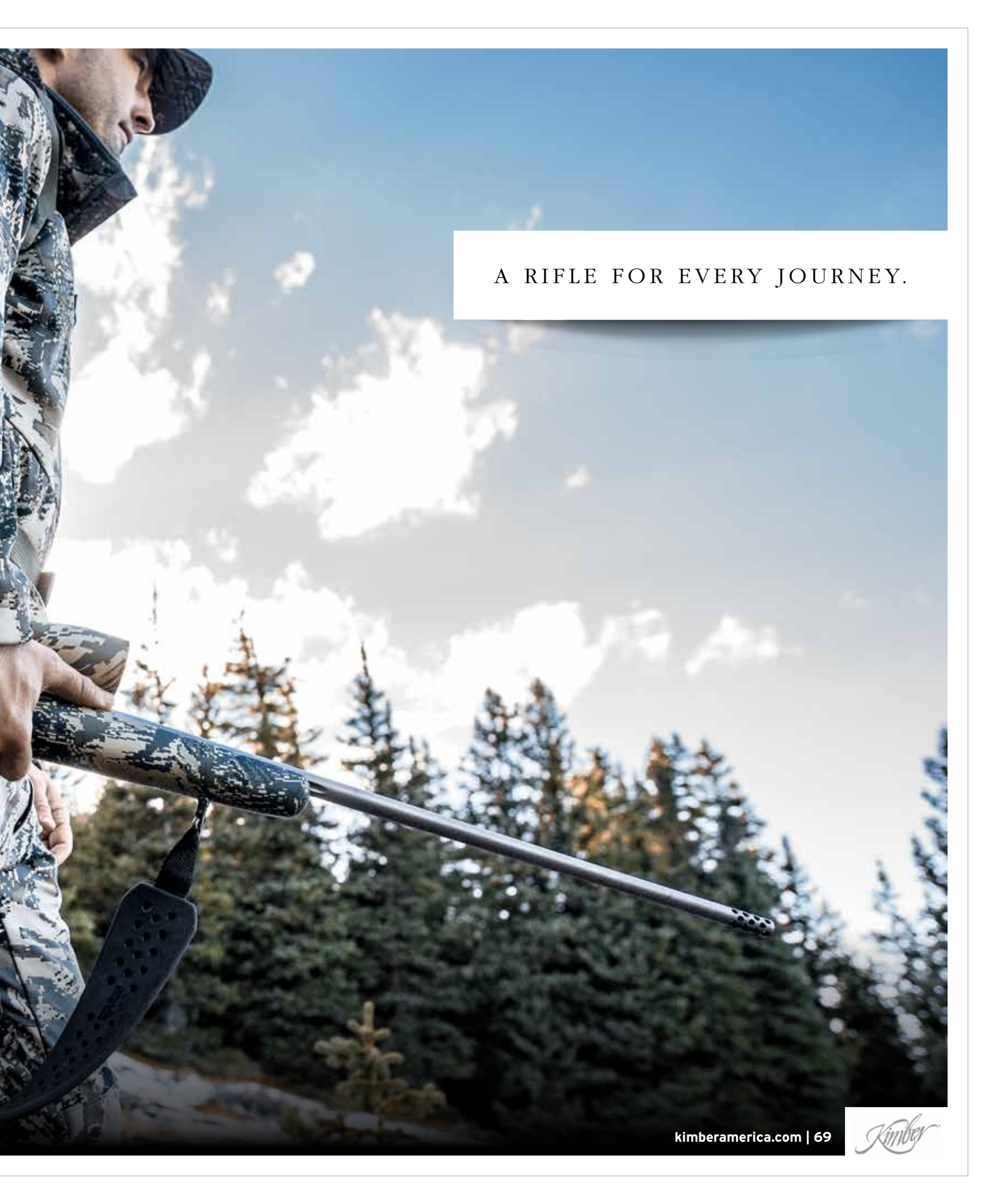

A RIFLE FOR EVERY JOURNEY.

OPTICS

A PERFECT MATCH for the Kimber Mountain Ascent™ and Adirondack™ rifles, the Zeiss Conquest V6 (offered in Gore™ Optifade™ Open Country and Elevated patterns) offers premium German optical performance and field versatility in a

compact, lightweight yet rugged body. The newly enhanced optical design provides extremely bright images and contrast for precision shooting, even at high magnifications and in low light conditions.

ZEISS CONQUEST V6	3-18x50		5-30x50	
	3	18	5	30
Magnification	3	18	5	30
Effective lens diameter	28.6 mm	50 mm	47.8 mm	50 mm
Exit pupil diameter	9.5 mm	2.8 mm	9.5 mm	1.7 mm
Twilight factor	8.5	30	14.1	38.7
Field of view at 100 Meters	12.4 M	2.1 M	7.4 m	1.2 m
Objective viewing angle	7.1°	1.2°	4.2°	0.7°
Diopter adjustment range	+3 / -2 dpt		-3 / 2 dpt	
Eye relief	90 mm		90 mm	
Parallax setting	45.7 - ∞		45.7 - ∞	
Elevation Adjustment Range	103 MOA		62 MOA	
Windage Adjustment Range	58 MOA		34 MOA	
Adjustment per click at 100 yards	1/4 MOA		1/4 MOA	
Center tube diameter	30 mm		30 mm	
Eyepiece tube diameter	45.5 mm		45.5 mm	
Objective tube diameter	56 mm		56 mm	
Coating	LotuTec® / ZEISS T*		LotuTec® / ZEISS T*	
Nitrogen filling	yes		yes	
Water resistant	400 mbar		400 mbar	
Operating temperature	-25 / +50° C		-25 / +50° C	
Length	338 mm		380 mm	
Weight	630 g		740 g	
Reticles	#6, ZBR-2, ZMOA-2		ZBR-1, ZMOA-1	

GORE™ OPTIFADE™
ELEVATED II PATTERN



GORE™ OPTIFADE™
OPEN COUNTRY PATTERN



MODEL	ITEM
Zeiss Conquest V6 Optifade Scope: 3-18x50 #6 Reticle x/ Hunting Turret / Open Country	4100721
Zeiss Conquest V6 Optifade Scope: 3-18x50 ZBR-2 Ballistic Reticle W/ Ballistic Turret / Open Country	4100722
Zeiss Conquest V6 Optifade Scope: 3-18x50 ZMOA-2 Reticle W/ Ballistic Turret / Open Country	4100723
Zeiss Conquest V6 Optifade Scope: 3-18x50 #6 Reticle W/ Hunting Turret / Elevated II	4100726
Zeiss Conquest V6 Optifade Scope: 3-18x50 ZBR-2 Ballistic Reticle W/ Ballistic Turret / Elevated II	4100727
Zeiss Conquest V6 Optifade Scope: 3-18x50 ZBR-2 Ballistic Reticle W/ Ballistic / Subalpine	4100728
Zeiss Conquest V6 Optifade Scope: 3-18x50 ZMOA-2 Reticle W/ Ballistic Turret / Subalpine	4100729
Zeiss Conquest V6 Optifade Scope: 5-30x50 ZBR-1 Ballistic Reticle W/ Ballistic Turret / Open Country	4100724
Zeiss Conquest V6 Optifade Scope: 5-30x50 ZMOA-1 Reticle W/Ballistic Turret / Open Country	4100725



AN EXCELLENT CHOICE for the Kimber Subalpine rifle, the Leupold VX®-6HD is begging to go where other scopes can't, featuring new High-Definition lenses for sharpened clarity, and the Twilight Max™ Light Management System for even

greater low-light performance. An in-scope cant indicator, throw lever for fast magnification changes and a robust erector system makes the VX-6HD ready for almost anything and everything.

LEUPOLD VX®-6HD	2-12 x 42mm (30mm) CDS-ZL2		3-18 x 44mm (30mm) CDS-ZL2	
	2X	12X	3X	18X
Magnification	2X	12X	3X	18X
Effective objective lens diameter	42mm	42mm	44mm	44mm
Exit pupil diameter	21mm	3.5mm	14.7mm	2.4mm
Field of view at 100 yds	57.5	10.2	38.2	6.9
Eye relief	3.8 in.		3.7 in.	
Total adjustment travel	120 MOA		75 MOA	
Adjustment per click	1/4 MOA		1/4 MOA	
Main tube diameter	30mm		30mm	
Gas filling type	Argon/Krypton		Argon/Krypton	
Waterproof	yes		yes	
Length	12.5 in		13.5 in	
Weight	16.8 oz		19 oz	
Model numbers	172955		173209	



CDS-ZL2 elevation dials deliver extended long-range accuracy and eliminate accidental dial rotation

EXCLUSIVE KIMBER RETICLE

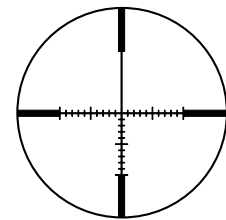

In-scope cant indicator in the illuminated reticle blinks when the VX®-6HD isn't level, for precise mounting and superior long-range accuracy

All VX®-6HD riflescopes include Alumina® flip-back lens covers



GORE™ OPTIFADE™ SUBALPINE PATTERN

Guard-ION hydrophobic lens coating protects lenses from the elements

MODEL	ITEM
Leupold Scope: 2-12X42mm / Firedot Triton / Subalpine	4100178
Leupold Scope: 3-18X44mm / Firedot Triton / Subalpine	4100179



PEPPERBLASTER II

STOP THREATS AT A DISTANCE

PEPPERBLASTER II



PEPPERBLASTER® II	
Dimensions (inches)	PBII L: 4.7, W: 1.0, H: 3.3
Weight (charged)	4.2 ounces (120 grams)
Effective range	2-13 feet
Operation	Double action with automatic switchover
Content	Liquid irritant, 2 charges per unit
Irritant agent	10% OC (oleoresin capsicum); 2.4% capsaicinoids
Charge volume	0.21 fluid ounces (6 ml/charge)
Charge velocity	112 MPH/164 FPS
Operating temperature	-4 °F (-20 °C) to 176 °F (+80 °C)
Drop safety	Drop tested to 5 feet (1.5 meters)
Water resistant	Yes
Shelf life	4 years

Caution: Strong irritant. Keep out of reach of children. May be unlawful to own or possess in some states or jurisdictions. Use for any purpose other than lawful self defense may be punishable by imprisonment, fines or both. PepperBlaster® protected by U.S. Pat. 6,951,070B2.

Technology, ergonomics and unmatched performance make PepperBlaster® II the most effective less-lethal protection

- A powerful solution of 10% Oleoresin Capsicum (OC) combines with benzyl alcohol to create the most effective inflammatory agent available. Effects are immediate and last up to 60 minutes.
- PepperBlaster® II uses patented Jet Protector Technology to propel two separate blasts of potent OC at 112 mph. This speed keeps each blast on target and reduces the risk of blowback or drift. Unlike sprays, PepperBlaster does not lose pressure over time.
- PepperBlaster II has an effective range of up to 13 feet, stopping threats at a distance. The unit does not have to be vertically indexed like sprays and can be fired from any angle or position.
- The non-aerosol pyrotechnic delivery system is not affected by cold or heat and blasts straight through wind and rain. This delivery system is capable of accurate placement and enough force to wrap around glasses or penetrate masks.

ACCESSORIES



MAGAZINES

Kimber® pistol magazines are available in an assortment of finishes, sizes and calibers. 1911 magazines fit Kimber pistols, plus almost any brand and model of MIL-SPEC 1911. The KimPro® Tac-Mag® is the finest 1911 .45 ACP magazine available today. Each has a quick-change system that permits immediate attachment of three included bases, along with large round count holes that read at a glance. Two sizes of Micro™ and Micro 9™ magazines are available. Standard and extended options available for both.



GRIPS

Kimber offers a full selection of premium grips and Crimson Trace Lasergrips® that fit almost any brand of 1911 pistol, regardless of caliber. Many feature hand-cut checkering and hand finishing. Crimson Trace Lasergrips® are also available for Micro™ and Micro 9™ pistols. Premium hex head grip screw sets are offered separately and add a finishing touch.



LOGO GEAR

Kimber offers a wide variety of logo apparel and gear, and the selection is always growing. Visit store.kimberamerica.com for a complete presentation.



KIMBER CUSTOM SHOP

The Kimber Custom Shop™ can quickly and professionally modify or personalize any Kimber pistol. Services include installation of night sights, custom finishes, part replacement, checkering, melts, custom parts and tuning.



HOLSTERS

An assortment of fine leather holsters and magazine carriers with the Kimber logo are available for Kimber 1911, Micro™ and Micro 9™ pistols. Kimber holsters also may fit other brands of MIL-SPEC 1911 pistols.



RIFLE ACCESSORIES

A selection of scopes, mounting systems for any application, along with extended bolt handles, leather logo slings, patterned slings to match your rifles, and other items are available to complete your rifle set up.



Kimber® pistols and rifles are shipped with a California-approved cable lock as a safety measure. Additionally, 1911 pistols are shipped in a lockable high-impact case, and both Micro and Solo® pistols are shipped in a lockable soft case. Use of the cable lock is encouraged at all times when a firearm is in storage. Kimber owners may request a free cable lock by mail. Please contact our customer service department at 888-243-4522.

Kimber firearms and less-lethal products should only be purchased and used in complete compliance with all laws; national, state and local. All suggestions for use in this catalog, or in any Kimber literature, must be taken within the context of these laws. Customers and dealers are required to comply with all applicable laws.

All Kimber centerfire 1911 and Solo pistols now include the Loaded Chamber Indicator Port® feature. When a round is in the chamber and light is available, the brass or silver color of the shell casing should be visible through the port in the barrel hood. This feature is another example of Kimber's commitment to firearm safety. However, one must never assume a firearm is unloaded until both the chamber and magazine are empty and the magazine is removed. Even then, all established rules of firearm safety must always be followed. Micro pistols do not have the Loaded Chamber Indicator Port® feature.

Firearm safety is every gun owner's responsibility. Use and store all firearms safely. Teach everyone in your home, especially children, proper firearm safety.

Kimber less-lethal products contain a strong irritant (inflammatory agent) derived from cayenne peppers. Avoid contact with skin and eyes. In case of contact, flush with water for at least 15 minutes. Seek immediate medical attention if symptoms persist or worsen. Always keep Kimber less-lethal products out of the reach of children. There is risk of injury to eyes if used at less than the minimum safe distances specified in the product instruction manual. Kimber less-lethal products may be unlawful to own or possess in some states and jurisdictions. Check with your state and local authorities. Use of Kimber less-lethal products for any purpose except lawful self-defense may be a crime. U.S. PAT. 6,951,070B2.

Certain products may not be available for sale in certain states.

©2018, Kimber Mfg., Inc. All rights reserved. The absence herein of any product name, mark, logo, etc. does not constitute a waiver by Kimber Mfg., Inc. of any intellectual property rights that Kimber Mfg., Inc. may own. Information and specifications presented are for reference only and subject to change without notice at any time. Company names other than Kimber Mfg., Inc. mentioned herein, and such other companies' respective product names, may be trademarks of such respective companies.



1911 PISTOL SPECIFICATIONS

NEW
NEW

Model	Page	Footnotes	Caliber	Available in California*										Frame								Slide			Barrel				Sights		Grips		Trigger	
				Height (inches)	Length (inches)	Width (inches)	Weight (ounces) w/ empty magazine	Magazine capacity	Recoil spring (pounds)	Guide rod	Melt treatment	Material	Finish	Ambidextrous thumb safety	Bumped & grooved grip safety	Front strap checkering (LPI)	Checkering under trigger guard (LPI)	Extended magazine well	High cut under trigger guard	Round Heel Frame	1913 Picatinny rail	Material	Finish	Front serrations	Flat top	Length (inches)	Material	Bushing	Twist rate (left hand)	Ramped	Black	Tritium Night Sights	Radius (inches)	Material
Ultra Carry™ II (Two-Tone)	10		.45 ACP	4.75	6.8	1.28	25	7	18	FG									ST	MB, BP			3	SS		16	•	FLP		4.8	RW		AL	4-5
Ultra Carry™ II (Two-Tone)	10		9mm	4.75	6.8	1.28	25	7	16	FG									ST	MB, BP			3	SS		16	•	FLP		4.8	RW		AL	4-5
Pro Carry™ II (Two-Tone)	10		.45 ACP	5.25	7.7	1.28	28	7	22	FG									ST	MB, BP			4	SS		16	•	FLP		5.7	RW		AL	4-5
Pro Carry™ II (Two-Tone)	10		9mm	5.25	7.7	1.28	28	9	14	FG									ST	MB, BP			4	SS		16	•	FLP		5.7	RW		AL	4-5
Custom II™ (Two-Tone)	10		.45 ACP	5.25	8.7	1.28	38	7	16	FG									SS	SIL, BP			5	SS	•	16	•	FLP		6.8	RW		AL	4-5
Custom II™ (Two-Tone)	10		9mm	5.25	8.7	1.28	38	7	12	FG									ST	MB, BP			5	SS	•	16	•	FLP		6.8	RW		AL	4-5
Stainless Ultra Carry™ II	11		.45 ACP	4.75	6.8	1.28	25	7	18	FG									SS	SIL			3	SS		16	•	FLP	FO	4.8	RW		AL	4-5
Stainless Ultra Carry™ II	11		9mm	4.75	6.8	1.28	25	8	16	FG									SS	SIL			3	SS		16	•	FLP	FO	4.8	RW		AL	4-5
Stainless Pro Carry™ II	11		.45 ACP	5.25	7.7	1.28	28	7	22	FG									SS	SIL			4	SS		16	•	FLP	FO	5.7	RW		AL	4-5
Stainless Pro Carry™ II	11		9mm	5.25	7.7	1.28	28	9	14	FG									SS	SIL			4	SS		16	•	FLP	FO	5.7	RW		AL	4-5
Stainless™ II	11		.45 ACP	5.25	8.7	1.28	38	7	16	FG									SS	SIL	•		5	SS	•	16	•	FLP	FO	6.8	RW		AL	4-5
Stainless™ II	11		9mm	5.25	8.7	1.28	38	9	12	FG									SS	SIL	•		5	SS	•	16	•	FLP	FO	6.8	RW		AL	4-5
Stainless Target™ (LS)	11		.45 ACP	5.25	9.7	1.28	42	7	16	SL									SS	SIL			6	SS	•	16		KA		7.8	RW		AL	4-5
Stainless Target™ (LS)	11		10mm	5.25	9.7	1.28	42	8	18.5	SL									SS	SIL			6	SS	•	16		KA		7.8	RW		AL	4-5
Stainless Target™ II	11		.45 ACP	5.25	8.7	1.28	38	7	16	FG									SS	SIL	•		5	SS	•	16		KA	FO	6.8	RW		AL	4-5
Stainless Target™ II	11		9mm	5.25	8.7	1.28	38	9	12	FG									SS	SIL	•		5	SS	•	16	•	KA	FO	6.8	RW		AL	4-5
Ultra TLE™ II	13		.45 ACP	4.75	6.8	1.28	25	7	18	FG									ST	MB			3	SS		16	•	FLP		4.8	GT		AL	4-5
Pro TLE™ II	13		.45 ACP	5.25	7.7	1.28	35	7	22	FG									ST	MB			4	SS		16		FLP		5.7	GT		AL	4-5
Pro TLE™ II (EM)	13		.45 ACP	5.5	7.7	1.28	35	7	22	FG									ST	MB			4	SS		16		FLP		5.7	GT		AL	4-5
Pro TLE/RL™ II	13		.45 ACP	5.25	7.7	1.28	36	7	22	FG									ST	MB			4	SS		16		FLP		5.7	GT		AL	4-5
Custom TLE™ II	13		.45 ACP	5.25	8.7	1.28	38	7	16	FG									ST	MB			5	SS	•	16		FLP		6.8	GT		AL	4-5
Custom TLE™ II (EM)	13		.45 ACP	5.5	8.7	1.28	38	7	16	FG									ST	MB			5	SS	•	16		FLP		6.8	GT		AL	4-5
Custom TLE™ II	13		10mm	5.25	8.7	1.28	38	8	18.5	FG									ST	MB			5	SS	•	16	•	FLP		6.8	GT		AL	4-5
Custom TLE/RL™ II	13		.45 ACP	5.25	8.7	1.28	39	7	16	FG									ST	MB			5	SS	•	16		FLP		6.8	GT		AL	4-5
Custom TLE/RL™ II (EM)	13		.45 ACP	5.5	8.7	1.28	39	7	16	FG									ST	MB			5	SS	•	16		FLP		6.8	GT		AL	4-5
Custom TLE/RL™ II	13		10mm	5.25	8.7	1.28	39	8	18.5	FG									ST	MB			5	SS	•	16	•	FLP		6.8	GT		AL	4-5
Custom TLE/RL™ II (TFS)	13	9	.45 ACP	5.25	9.19	1.28	39	7	16	FG									ST	MB			5.5	SS	•	16		FC,SH		6.8	GT		AL	4-5
Custom TLE/RL™ II (TFS)	13	9	9mm	5.25	9.19	1.28	39	9	12	FG									ST	MB			5.5	SS	•	16	•	FC,SH		6.8	GT		AL	4-5
Stainless Ultra TLE™ II	13		.45 ACP	4.75	6.8	1.28	25	7	18	FG									SS	SIL			3	SS		16	•	FLP		4.8	GT		AL	4-5
Stainless Pro TLE™ II	13		.45 ACP	5.25	7.7	1.28	35	7	22	FG									SS	SIL			4	SS		16		FLP		5.7	GT		AL	4-5
Stainless Pro TLE/RL™ II	13		.45 ACP	5.25	7.7	1.28	36	7	22	FG									SS	SIL			4	SS		16		FLP		5.7	GT		AL	4-5
Stainless TLE™ II	13		.45 ACP	5.25	8.7	1.28	38	7	16	FG									SS	SIL	•		5	SS	•	16		FLP		6.8	GT		AL	4-5
Stainless TLE/RL™ II	13		.45 ACP	5.25	8.7	1.28	39	7	16	FG									SS	SIL	•		5	SS	•	16		FLP		6.8	GT		AL	4-5
Eclipse Pro™	14		.45 ACP	5.25	7.7	1.28	35	8	22	FG									SS	CG, BP			4	SS		16		FLP		5.7	GT		PA	4-5
Eclipse Custom™	14		.45 ACP	5.25	8.7	1.28	38	8	16	FG									SS	CG, BP			5	SS	•	16		FLP		6.8	GT		PA	4-5
Eclipse Custom™	14		10mm	5.25	8.7	1.28	38	8	18.5	FG									SS	CG, BP			5	SS	•	16	•	FLP		6.8	GT		PA	4-5
Eclipse Target™	14		.45 ACP	5.25	8.7	1.28	38	8	16	FG									SS	CG, BP			5	SS	•	16		KA B/D		6.8	GT		PA	4-5
Eclipse Target™	14		.38 Super	5.25	8.7	1.28	38	8	16	FG									SS	CG, BP			5	SS	•	16		KA B/D		6.8	GT		PA	4-5
Warrior®	15	4, 10	.45 ACP	5.25	8.7	1.28	40	7	16	SL									ST	MB, KP			5	SS	•	16		TW		6.8	GT		SA	4-5
Desert Warrior®	15	4	.45 ACP	5.25	8.7	1.28	40	7	16	SL	SM								ST	DT, KP			5	SS	•	16		TW		6.8	GT		SA	4-5
Desert Warrior® (TFS)	15	4, 9	.45 ACP	5.25	9.19	1.28	40	7	16	SL	SM								ST	DT, KP			5.5	SS	•	16		FC,SH		6.8	GT		SA	4-5
Warrior® SOC	15	1, 4	.45 ACP	5.25	8.7	1.28	40	7	16	SL	SM	ST	DE/DG, KP						ST	DE/DG, KP			5	SS	•	16		TW		6.8	GT		SA	4-5
Warrior® SOC (TFS)	15	1, 4, 9	.45 ACP	5.25	9.19	1.28	40	7	16	SL	SM	ST	DE/DG, KP						ST	DE/DG, KP			5.5	SS	•	16		FC,SH		6.8	GT		SA	4-5
Ultra CDP™	16		.45 ACP	4.75	6.8	1.28	25	7	18	FG									SS	SIL, KP			3	SS		16	•	FLP		4.8	RW		PA	4-5
Ultra CDP™ (LG)	16		.45 ACP	4.75	6.8	1.28	25	7	18	FG									SS	SIL, KP			3	SS		16	•	FLP		4.8	RW, LG		PA	4-5
Ultra CDP™	16		9mm	4.75	6.8	1.28	25	8	16	FG									SS	SIL, KP			3	SS		16	•	FLP		4.8	RW		PA	4-5
Ultra+ CDP™	16		.45 ACP	5.25	6.8	1.28	27	7	16	FG									SS	SIL, KP			3	SS		16	•	FLP		4.8				

1911 PISTOL SPECIFICATIONS

Model	Page	Footnotes	Caliber	Available in California*												Frame					Slide					Barrel					Sights			Grips		Trigger
				Height (inches)	Length (inches)	Width (inches)	Weight (ounces) w/ empty magazine	Magazine capacity	Recoil spring (pounds)	Guide rod	Melt treatment	Material	Finish	Ambidextrous thumb safety	Bumped & grooved grip safety	Front strap checkering (LPI)	Checking under trigger guard (LPI)	Extended magazine well	High cut under trigger guard	Round Heel Frame	1913 Picatinny rail	Material	Finish	Front serrations	Flat top	Length (inches)	Material*	Bushing	Twist rate (left hand)	Ramped	Black	Tritium Night Sights	Radius (inches)	Material	Kimber logo	Type
Gold Match™ II	24		.45 ACP	5.25	8.7	1.28	38	8	16	FG	ST	MB, KP							ST	MB, KP			5	SS	*	16		KA		6.8	RW		PA	4-5		
Stainless Gold Match™ II	24		.45 ACP	5.25	8.7	1.28	38	8	16	FG	SS	SIL, KP							SS	SIL, KP			5	SS	*	16		KA		6.8	RW	LA	PA	4-5		
Team Match™ II	24	2	.45 ACP	5.5	8.7	1.28	39	8	16	FG	SS	SIL, KP	*	30	*				SS	MB, KP	*		5	SS	*	16		KA		6.8	RW, LA		PA	4-5		
Team Match™ II	24	2	9mm	5.5	8.7	1.28	39	9	12	FG	SS	SIL, KP	*	30	*				SS	MB, KP	*		5	SS	*	16	*	KA		6.8	RW, LA		PA	4-5		
Rimfire Compact Conversion Kit™	25		.22 LR		7.7		13	10		FG									AL	SIL			4	ST	*	16	*	FLP		5.7						
Rimfire Compact Conversion Kit™	25		.22 LR		7.7		13	10		FG									AL	MB			4	ST	*	16	*	FLP		5.7						
Rimfire Target Conversion Kit™	25		.22 LR		8.7		15	10		FG									AL	SIL	*		5	ST	*	16	*	KA		6.8						
Rimfire Target Conversion Kit™	25		.22 LR		8.7		15	10		FG									AL	MB	*		5	ST	*	16	*	KA		6.8						
KHX Ultra	22		.45 ACP	4.75	6.8	1.28	25	7	18	FG	AL	KP		SP	*				SS	KP	*		3	SS	*	16	*	FO	4.8	GTMG, LEG		PA	4-5			
KHX Ultra	22		9mm	4.75	6.8	1.28	25	8	16	FG	AL	KP		SP	*				SS	KP	*		3	SS	*	16	*	FO	4.8	GTMG, LEG		PA	4-5			
KHX Pro	22		.45 ACP	5.25	7.7	1.28	35	7	22	FG	SS	KP		SP	*				SS	KP	*		4	SS	*	16	*	FO	5.7	GTMG, LEG		PA	4-5			
KHX Pro	22		9mm	5.25	7.7	1.28	35	7	22	FG	SS	KP		SP	*				SS	KP	*		4	SS	*	16	*	FO	5.7	GTMG, LEG		PA	4-5			
KHX Pro (OR)	22		.45 ACP	5.25	7.7	1.28	35	7	22	FG	SS	KP		SP	*				SS	KP	*		4	SS	*	16	*	ORWVD	5.7	GTMG		PA	4-5			
KHX Pro (OR)	22		9mm	5.25	7.7	1.28	35	8	14	FG	SS	KP		SP	*				SS	KP	*		4	SS	*	16	*	ORWVD	5.7	GTMG		PA	4-5			
KHX Custom	22		.45 ACP	5.25	8.7	1.28	38	8	16	FG	SS	KP		SP	*				SS	KP	*	*	5	SS	*	16	*	FO	6.8	GTMG, LEG		PA	4-5			
KHX Custom	22		9mm	5.25	8.7	1.28	38	9	12	FG	SS	KP		SP	*				SS	KP	*	*	5	SS	*	16	*	FO	6.8	GTMG, LEG		PA	4-5			
KHX Custom (OR)	22		.45 ACP	5.25	8.7	1.28	38	8	16	FG	SS	KP		SP	*				SS	KP	*	*	5	SS	*	16	*	FO	6.8	GTMG		PA	4-5			
KHX Custom (OR)	22		9mm	5.25	8.7	1.28	38	9	12	FG	SS	KP		SP	*				SS	KP	*	*	5	SS	*	16	*	ORWVD	6.8	GTMG		PA	4-5			
Aegis Elite Ultra	23		.45 ACP	4.75	6.8	1.28	25	7	18	FG	AL	SIL		24	*				SS	KP	*		3	SS	*	16	*	FO	4.8	GT		PA	4-5			
Aegis Elite Ultra	23		9mm	4.75	6.8	1.28	25	8	16	FG	AL	SIL		24	*				SS	KP	*		3	SS	*	16	*	FO	4.8	GT		PA	4-5			
Aegis Elite Pro	23		.45 ACP	5.25	7.7	1.28	35	7	22	FG	SS	SIL		24	*				SS	KP	*		4	SS	*	16	*	FO	5.7	GT		PA	4-5			
Aegis Elite Pro	23		9mm	5.25	7.7	1.28	35	8	14	FG	SS	SIL		24	*				SS	KP	*		4	SS	*	16	*	FO	5.7	GT		PA	4-5			
Aegis Elite Pro (OI)	23		.45 ACP	5.25	7.7	1.28	35	7	22	FG	SS	SIL		24	*				SS	KP	*		4	SS	*	16	*	V		GT		PA	4-5			
Aegis Elite Pro (OI)	23		9mm	5.25	7.7	1.28	35	8	14	FG	SS	SIL		24	*				SS	KP	*		4	SS	*	16	*	V		GT		PA	4-5			
Aegis Elite Custom (OI)	23		.45 ACP	5.25	8.7	1.28	38	8	16	FG	SS	SIL		24	*				SS	KP	*	*	5	SS	*	16	*	V		GT		PA	4-5			
Aegis Elite Custom (OI)	23		9mm	5.25	8.7	1.28	38	9	12	FG	SS	SIL		24	*				SS	KP	*	*	5	SS	*	16	*	V		GT		PA	4-5			
Aegis Elite Custom	23		.45 ACP	5.25	8.7	1.28	38	8	16	FG	SS	SIL		24	*				SS	KP	*	*	5	SS	*	16	*	FO	6.8	GT		PA	4-5			
Aegis Elite Custom	23		9mm	5.25	8.7	1.28	38	9	12	FG	SS	SIL		24	*				SS	KP	*	*	5	SS	*	16	*	FO	6.8	GT		PA	4-5			
Sapphire Ultra™ II	27		9mm	4.75	6.8	1.15	25	8	16	FG	AL	SIL	*	BM	*				SS	BB	*		3	SS	*	16	*	TW	4.8	GT		SA	4-5			
Sapphire Ultra™ II	27		.45 ACP	4.75	6.8	1.15	25	7	18	FG	AL	SIL	*	BM	*				SS	BB	*		3	SS	*	16	*	TW	4.8	GT		SA	4-5			
Sapphire Pro™ II	27		9mm	5.25	7.7	1.28	28	9	14	FG	AL	SIL	*	BM	*				SS	BB	*		4	SS	*	16	*	TW	5.7	GT		SA	4-5			
Sapphire Pro™ II	27		.45 ACP	4.75	6.8	1.15	25	7	18	FG	AL	SIL	*	BM	*				SS	AP	*		3	SS	*	16	*	TW	4.8	GT		SA	4-5			
Amethyst Ultra™ II	27		9mm	4.75	6.8	1.15	25	8	16	FG	AL	SIL	*	BM	*				SS	AP	*		3	SS	*	16	*	TW	4.8	GT		SA	4-5			
Amethyst Ultra™ II	27		.45 ACP	4.75	6.8	1.15	25	7	18	FG	AL	SIL	*	BM	*				SS	AP	*		3	SS	*	16	*	TW	4.8	GT		SA	4-5			
Rose Gold Ultra™ II	27		.45 ACP	4.75	6.8	1.15	25	7	18	FG	AL	MB, KP	*	BM	*				SS	RG	*		3	SS	*	16	*	TW	4.8	GT		SA	4-5			
Rose Gold Ultra™ II	27		9mm	4.75	6.8	1.15	25	8	16	FG	AL	MB, KP	*	BM	*				SS	RG	*		3	SS	*	16	*	TW	4.8	GT		SA	4-5			
Stainless™ II (Classic Engraved)	27		.45 ACP	5.25	8.7	1.28	38	7	16	FG	SS	SIL	*	BM	*				SS	SIL	*	*	5	SS	*	16	*	FLP	6.8	W/MI		PA	4-5			
Camp Guard 10™	27		10mm	5.25	8.7	1.28	38	8	18.5	SL	SS	SIL		30	*				SS	MB, KP	*		5	SS	*	16	*	TW	6.8	RW		PA	4-5			
Hero Custom	26	13	.45 ACP	5.25	8.7	1.28	38	8	16	FG	SS	SIL		30	*				SS	SIL	*	*	5	SS	*	16	*	GT								
Super Jägare™	28	12	10mm	5.25	9.7	1.28	42	8	18.5	SL	CM	SS	CG, KP	*	SC	*	*		SS	DLC		SC	6	SS	*	16	*	DP		MI		PA	4-5			
Super Match™ II	29	6, 11	.45 ACP	5.5	8.7	1.28	39	8	16	FG	SS	SIL	*	30	30	*	*		SS	MB, KP	FL	SE	5	SS	*	16	*	KA		6.8	W		PA	4-5		
Ultra RCP™ II (LG)	29		.45 ACP	4.75	6.8	1.28	25	7	18	FG	CM	AL	CG, KP		BM	*				MB, KP									4.8	RW, LG		SA	4-5			
Classic Carry Pro™	29		.45 ACP	5.25	7.7	1.28	35	8	22	FG	AL	CB, BP							ST	CB, BP								FLP, CS	5.7	GT		SA	4-5			
Royal™ II	29		.45 ACP	5.25	8.7	1.28	38	7	16	FG	ST	CB, BP							ST	CB, BP	*		5	ST	*	16	*	FLP	6.8	BO		SA	4-5			
Gold Combat™ II	29	6	.45 ACP	5.5	8.7	1.28	39	8	16	FG	SS	MB, P, KP	*	24	30	*	*		SS	MB, KP	FL	SE	5	SS	*	16	*	FLP, CS	6.8	GT		PA	4-5			
Gold Combat RL™ II	29	6	.45 ACP	5.5	8.7	1.28	40	8	16	FG	SS	MB, P, KP	*	24	30	*	*		SS	MB, KP	FL	SE	5	SS	*	16	*	FLP, CS	6.8	GT		PA	4-5			
Gold Combat Stainless™ II	29	6	.45 ACP	5.5	8.7	1.28	39	8	16	FG	SS	SIL, P, KP	*	24	30	*	*		SS	SIL, KP	FL	SE	5	SS	*	16	*	FLP, CS	6.8	GT		PA	4-5			

*Barrel material for 1911 pistols available in California may be carbon steel rather than stainless steel where indicated.

FEATURE KEY

AL	Aluminum	FLP	Fixed low profile	P	Polished flats
AP	Amethyst purple PVD finish	FLP, CS	Fixed low profile, cocking shoulder	PA	Premium Aluminum
BA	Bel Air Blue				

REVOLVER, MICRO & MICRO 9 SPECIFICATIONS

FEATURE KEY

BR	Black rubber
BRS	Brushed stainless finish
DAO	Double action only
DLC	Diamond-like carbon finish
HP	High polish
LW	Laminated wood
MS	Crimson Trace Master Series™ Lasergrips®
SIL	Satin Silver
SS	Stainless steel

Model	Page	Caliber	Available in California*	Height (inches)	Length (inches)	Width (inches)	Weight (ounces) w/ empty cylinder	Cylinder capacity	Action	Material	Finish	Backstrap	Material	Finish	Length (inches)	Material	Finish	Black serrated	Tritium Night Sights	Fiber Optic	Radius (inches)	Material	Kimber logo	Factory setting (appx. pounds)
K6s® Stainless™	47	.357 Mag.	-	4.46	6.62	1.39	23	6	DAO	SS	BRS	SE	SS	BRS	2	SS	BRS	-	-	-	4.1	BR	-	9.5-10.5
K6s® Stainless™ (LG)	47	.357 Mag.	-	4.46	6.62	1.39	23	6	DAO	SS	BRS	SE	SS	BRS	2	SS	BRS	-	-	-	4.1	MS	-	9.5-10.5
K6s® Stainless™ (NS)	47	.357 Mag.	-	4.46	6.62	1.39	23	6	DAO	SS	BRS	SE	SS	BRS	2	SS	BRS	-	-	-	4.1	BR	-	9.5-10.5
K6s® Stainless™ (3")	46	.357 Mag.	-	5	7.62	1.39	25.1	6	DAO	SS	BRS	SE	SS	BRS	3	SS	BRS	-	-	-	5.1	W	-	9.5-10.5
K6s® DCR™	47	.357 Mag.	-	4.46	6.62	1.39	23	6	DAO	SS	SIL	SE	SS	SIL	2	SS	SIL	-	-	-	4.1	LW	-	9.5-10.5
K6s® DC™	47	.357 Mag.	-	4.46	6.62	1.39	23	6	DAO	SS	BRS/DLC	SE	SS	BRS/DLC	2	SS	BRS/DLC	-	-	-	4.1	GT	-	9.5-10.5
K6s® CDP™	47	.357 Mag.	-	4.46	6.62	1.39	23	6	DAO	SS	BRS/DLC	SE	SS	BRS	2	SS	BRS	-	-	-	4.1	RW	-	9.5-10.5

Model	Page	Footnotes	Caliber	Height (inches)	Length (inches)	Width (inches)	Weight (ounces) w/ empty magazine	Magazine capacity	Recoil spring (pounds)	Guide rod	Melt treatment	Material	Finish	Ambidextrous thumb safety	Front strap checkering (LPI)	Material	Finish	Length (inches)	Material	Twist rate (left hand)	Ramped	White Dot Sights	Tritium Night Sights	TRUGLO TFX Pro Day/Night Sights	Radius (inches)	Material	Kimber logo	Type	Factory setting (appx. pounds)
Micro Stainless Rosewood™	35	1, 2	.380 ACP	4	5.6	1.07	13.4	7	8	FG		AL	SIL			SS	SIL	2.75	SS	16	-	-	-	3.9	RW	-	SA	7	
Micro CDP™	37	1, 2	.380 ACP	4	5.6	1.07	13.4	7	8	FG	CM	AL	MB	-	30	SS	SIL	2.75	SS	16	-	-	-	3.9	RW	-	SA	7	
Micro CDP™ (LG)	37	1, 2	.380 ACP	4	5.6	1.07	13.4	7	8	FG	CM	AL	MB	-	30	SS	SIL	2.75	SS	16	-	-	-	3.9	RW, LG	-	SA	7	
Micro Raptor™	36	1, 2	.380 ACP	4	5.6	1.07	13.4	7	8	FG		AL	MB	-	SR	SS	MB	2.75	SS	16	-	-	-	3.9	ZW	-	SA	7	
Micro Raptor Stainless™	36	1, 2	.380 ACP	4	5.6	1.07	13.4	7	8	FG		AL	SIL	-	SR	SS	SIL	2.75	SS	16	-	-	-	3.9	ZW	-	SA	7	
Micro Carry Advocate™	37	1, 2	.380 ACP	4	5.6	1.07	13.4	7	8	FG		AL	SIL			SS	MB	2.75	SS	16	-	-	-	3.9	GT	-	SA	7	
Micro Carry Advocate™ purple/black grips	37	1, 2	.380 ACP	4	5.6	1.07	13.4	7	8	FG		AL	SIL			SS	MB	2.75	SS	16	-	-	-	3.9	GT	-	SA	7	
Micro Crimson Carry™	37	1, 2	.380 ACP	4	5.6	1.07	13.4	7	8	FG		AL	SIL			SS	MB	2.75	SS	16	-	-	-	3.9	RW, LG	-	SA	7	
Micro Sapphire™	36	1, 2	.380 ACP	4	5.6	1.07	13.4	7	8	FG		AL	SIL	-	BM	SS	BB	2.75	SS	16	-	-	-	3.9	GT	-	SA	7	
Micro Rose Gold™	36	1, 2	.380 ACP	4	5.6	1.07	13.4	7	8	FG		AL	SIL	-	BM	SS	RG	2.75	SS	16	-	-	-	3.9	GT	-	SA	7	
Micro Amethyst™	36	1, 2	.380 ACP	4	5.6	1.07	13.4	7	8	FG		AL	SIL	-	BM	SS	AP	2.75	SS	16	-	-	-	3.9	GT	-	SA	7	
Micro Bel Air™	36	1, 2	.380 ACP	4	5.6	1.07	13.4	7	8	FG		AL	BA			SS	MP	2.75	SS	16	-	-	-	3.9	GT	-	SA	7	
Micro RCP™	37	1, 2	.380 ACP	4	5.6	1.07	13.4	7	8	FG	CM	AL	MB	-	BM	SS	KP	2.75	SS	16	-	-	-	3.9	RW	-	SA	7	
Micro RCP™ (LG)	37	1, 2	.380 ACP	4	5.6	1.07	13.4	7	8	FG	CM	AL	MB	-	BM	SS	KP	2.75	SS	16	-	-	-	3.9	RW, LG	-	SA	7	
Micro DC™	37	1, 2	.380 ACP	4	5.6	1.07	13.4	7	8	FG		AL	MB	-		SS	MB	2.75	SS	16	-	-	-	3.9	GT	-	SA	7	
Micro DC™ (LG)	37	1, 2	.380 ACP	4	5.6	1.07	13.4	7	8	FG		AL	MB	-		SS	MB	2.75	SS	16	-	-	-	3.9	BLK, LG	-	SA	7	
Micro™ Two-Tone	36	1, 2	.380 ACP	4	5.6	1.07	13.4	7	8	FG		AL	SIL			SS	MB	2.75	SS	16	-	-	-	3.9	RW	-	SA	7	
Micro Desert Night	35	1, 2	.380 ACP	4	5.6	1.07	13.4	7	8	FG		AL	DT, KP			SS	MB, KP	2.75	SS	16	-	-	-	3.9	GT	-	SA	7	
Micro Desert Tan (LG)	35	1, 2	.380 ACP	4	5.6	1.07	13.4	7	8	FG		AL	MB			SS	DT, KP	2.75	SS	16	-	-	-	3.9	DT, LG	-	SA	7	
Micro Covert	34	1, 2	.380 ACP	4	5.6	1.07	13.4	7	8	FG		AL	CG		30	SS	CG, KP	2.75	SS	16	-	-	-	3.9	UC, LG	-	SA	7	
Micro Eclipse	35	1, 2	.380 ACP	4	5.6	1.07	13.4	7	8	FG		AL	CG		30	SS	P	2.75	SS	16	-	-	-	3.9	GT	-	SA	7	
Micro TLE	35	1, 2	.380 ACP	4	5.6	1.07	13.4	7	8	FG		AL	MB		30	SS	MB	2.75	SS	16	-	-	-	3.9	GT	-	SA	7	
Micro 9™ Sapphire	40	1, 2	9mm	4.07	6.1	1.08	15.6	7	16	FG		AL	SIL	-	BM	SS	BB	3.15	SS	16	-	-	-	4.3	GT	-	SA	7	
Micro 9™ Rose Gold	40	1, 2	9mm	4.07	6.1	1.08	15.6	7	16	FG		AL	SIL	-	BM	SS	RG	3.15	SS	16	-	-	-	4.3	GT	-	SA	7	
Micro 9™ Two-Tone	41	1, 2	9mm	4.07	6.1	1.08	15.6	7	16	FG		AL	SIL			SS	MB	3.15	SS	16	-	-	-	4.3	RW	-	SA	7	
Micro 9™ Crimson Carry	41	1, 2	9mm	4.07	6.1	1.08	15.6	7	16	FG		AL	SIL, KP			SS	MB	3.15	SS	16	-	-	-	4.3	RW, LG	-	SA	7	
Micro 9™ Stainless	42	1, 2	9mm	4.07	6.1	1.08	15.6	7	16	FG		AL	SIL			SS	SIL	3.15	SS	16	-	-	-	4.3	RW	-	SA	7	
Micro 9™ CDP	43	1, 2	9mm	4.07	6.1	1.08	15.6	7	16	FG	CM	AL	MB	-	30	SS	SIL	3.15	SS	16	-	-	-	4.3	RW	-	SA	7	
Micro 9™ CDP (LG)	43	1, 2	9mm	4.07	6.1	1.08	15.6	7	16	FG	CM	AL	MB	-	30	SS	SIL	3.15	SS	16	-	-	-	4.3	RW, LG	-	SA	7	
Micro 9™ Stainless Raptor	40	1, 2	9mm	4.07	6.1	1.08	15.6	7	16	FG		AL	SIL, KP	-	SR	SS	SIL	3.15	SS	16	-	-	-	4.3	ZW	-	SA	7	
Micro 9™ Bel Air	41	1, 2	9mm	4.07	6.1	1.08	15.6	7	16	FG		AL	BA			SS	MP	3.15	SS	16	-	-	-	4.3	GT	-	SA	7	
Micro 9™ Desert Night (LG)	42	1, 2	9mm	4.07	6.1	1.08	15.6	7	16	FG		AL	DT			SS	MB	3.15	SS	16	-	-	-	4.3	BLK, LG	-	SA	7	
Micro 9™ (LG)	39	1, 2	9mm	4.07	6.1	1.08	15.6	7	16	FG		AL	MB			SS	MB	3.15	SS	16	-	-	-	4.3	DT, LG	-	SA	7	
Micro 9™ Desert Tan (LG)	40	1, 2	9mm	4.07	6.1	1.08	15.6	7	16	FG		AL	MB			SS	DT, KP	3.15	SS	16	-	-	-	4.3	DT, LG	-	SA	7	
Micro 9™ Woodland Night (LG)	39	1, 2	9mm	4.07	6.1	1.08	15.6	7	16	FG		AL	CG			SS	MB	3.15	SS	16	-	-	-	4.3	DG, LG	-	SA	7	
Micro 9™ Stainless (DN)	42	1, 2	9mm	4.07	6.1	1.08	15.6	7	16	FG		AL	SIL			SS	SIL	3.15	SS	16	-	-	-	4.1	WG	-	SA	7	
Micro 9™ Two-Tone (DN)	41	1, 2	9mm	4.07	6.1	1.08	15.6	7	16	FG		AL	SIL			SS	MB	3.15	SS	16	-	-	-	4.1	WG	-	SA	7	
Micro 9™ Nightfall (DN)	43	1, 2	9mm	4.07	6.1	1.08	15.6	7	16	FG		AL	MB			SS	MB	3.15	SS	16	-	-	-	4.1	WG	-	SA	7	
Micro 9™ Desert Night (DN)	42	1, 2	9mm	4.07	6.1	1.08	15.6	7	16	FG		AL	DT			SS	MB	3.15	SS	16	-	-	-	4.1	WG	-	SA	7	
Micro 9™ CDP (DN)	43	1, 2	9mm	4.07	6.1	1.08	15.6	7	16	FG	CM	AL	MB	-	30	SS	SIL	3.15	SS	16	-	-	-	4.1	WG	-	SA	7	
Micro 9™ Covert	39	1, 2	9mm	4.07	6.1	1.08	15.6	7	16	FG		AL	CG		30	SS	CG, KP	3.15	SS	16	-	-	-	4.3	UC, LG	-	SA	7	
Micro 9™ Eclipse	38	1, 2	9mm	4.07	6.1	1.08	15.6	7	16	FG		AL	CG		30	SS	P	3.15	SS	16	-	-	-	4.3	GT	-	SA	7	
Micro 9™ TLE	39	1, 2	9mm	4.07	6.1	1.08	15.6	7	16	FG		AL	MB		30	SS	MB	3.15	SS	16	-	-	-	4.3	GT	-	SA	7	

FEATURE KEY

AL	Aluminum	CG	Charcoal gray	FW	French walnut	MB	Matte black	SIL	Satin Silver
AP	Amethyst purple PVD finish	CM	Carry Melt™ treatment	GM	Gunmetal PVD finish	MI	Micarta	SL	Standard or military-length guide rod
BA	Bel Air Blue™ finish	DE/DG	Dark earth/dark green	GRU	Gray Rubber	MP	Mirror polished	SM	Service Melt™ treatment
BB	Bright blue PVD finish	DLC	Diamond-Like Carbon coating	GT	G-10	MS	Crimson Trace Master Series™ Lasergrips®	SR	Scaled Raptor™ pattern
BC	Back-cut serrations	DT	Desert Tan	HF	Highly polished flats	P	Polished flats	SS	Stainless steel
BM	Ball-milled front strap	DP	DeltaPoint Pro optic	HP	High polish	PA	Premium Aluminum	ST	Steel
BO	Bone	FC, SH	Fixed cocking shoulder, suppressor height	HS	Horizontal serrations	PF	Pau Ferro	TW	Tactical Wedge
BP	Brush polished flats	FG	Full-length guide rod	KP	KimPro™ II	RG	Rose gold PVD finish	TL	Tactical Ledge
BR	Black rubber	FL	Fine line	KA	Kimber adjustable	RW	Rosewood	UC	Urban camouflage
BRS	Brushed stainless finish	FLP	Fixed low profile	KA B/D	Kimber adjustable bar/dot	SA	Solid aluminum	W	Walnut
BS	Black synthetic	FLP, CS	Fixed low profile, cocking shoulder	LG	Crimson Trace Lasergrips®	SC	Super Carry™ pattern	WG	Hoque Wraparound Grip
CB	Charcoal blue	FO	Fiber optic front sight	LW	Laminated wood	SE	Serrations	ZW	Zebra wood

FOOTNOTES

- All magazine capacities are given with the extended magazines. Flush fit magazines capacity for both Micro 9™ and Micro are 6 rounds.
- All Crimson Carry, Master Carry, Super Carry and Micro models, along with the Classic Carry Pro, have

RIFLE SPECIFICATIONS

CALIBER-SPECIFIC INFORMATION

Model	Caliber	Action	Page	Footnotes	Stock			Barrel				Magazine capacity	Approx. weight (pounds/ounces) ¹	Overall length (inches)
					Length of pull (inches)	Drop at heel (inches)	Drop at comb (inches)	Barrel length (inches)	Muzzle diameter (inches)	Twist rate (right hand)				
Classic Select Grade™	.223 Rem.	84M	52	1	13.7	0.54	0.43	22	0.56	9	6	5/13	41.25	
	.243 Win.	84M	52	1	13.7	0.54	0.43	22	0.56	10	5	5/13	41.25	
	.257 Roberts	84M	52	1	13.7	0.54	0.43	22	0.56	10	5	5/12	41.25	
	7mm-08 Rem.	84M	52	1	13.7	0.54	0.43	22	0.56	9	5	5/10	41.25	
	.308 Win.	84M	52	1	13.7	0.54	0.43	22	0.56	10	5	5/10	41.25	
	.25-06 Rem.	84L	52	1	13.8	0.54	0.43	24	0.56	10	5	6/3	43.75	
	.270 Win.	84L	52	1	13.8	0.54	0.43	24	0.56	10	5	6/2	43.75	
	.280 Ack. Imp.	84L	52	1	13.8	0.54	0.43	24	0.56	9	5	6/2	43.75	
	.30-06 Sprg.	84L	52	1	13.8	0.54	0.43	24	0.56	10	5	6/2	43.75	
	.270 WSM	8400 SM	52	1	13.5	0.54	0.43	24	0.56	10	3	6/10	43.5	
	.300 WSM	8400 SM	52	1	13.5	0.54	0.43	24	0.56	10	3	6/10	43.5	
	7mm Rem. Mag.	8400 LM	52	1	13.8	0.54	0.43	26	0.56	9.5	4	7/4	46.5	
	.300 Win. Mag.	8400 LM	52	1	13.8	0.54	0.43	26	0.56	10	4	7/4	46.5	
.338 Win. Mag.	8400 LM	52	1	13.8	0.54	0.43	26	0.56	10	4	7/4	46.5		
SuperAmerica™	.308 Win.	84M	52	1	13.7	0.54	0.43	22	0.56	10	5	5/10	41.25	
Hunter	.243 Win.	84M	54		13.7	0.54	0.43	22	0.56	10	3	5/10	41.25	
	.257 Roberts	84M	54		13.7	0.54	0.43	22	0.56	10	3	5/10	41.25	
	6.5 Creedmoor	84M	54		13.7	0.54	0.43	22	0.56	8	3	5/9	41.25	
	7mm-08 Rem.	84M	54		13.8	0.54	0.43	22	0.56	9	3	5/7	41.25	
	.308 Win.	84M	54		13.7	0.54	0.43	22	0.56	10	3	5/7	41.25	
	.270 Win.	84L	54		13.8	0.54	0.43	24	0.56	10	3	5/13	43.75	
	.280 Ack. Imp.	84L	54		13.8	0.54	0.43	24	0.56	9	3	5/12	43.75	
.30-06 Sprg.	84L	54		13.8	0.54	0.43	24	0.56	10	3	5/11	43.75		
Montana™	.223 Rem.	84M	56	4	13.7	0.54	0.43	22	0.56	9	5	5/6	41.25	
	.22-250 Rem.	84M	56	4	13.7	0.54	0.43	22	0.56	14	5	5/6	41.25	
	.243 Win.	84M	56	4	13.7	0.54	0.43	22	0.56	10	4	5/5	41.25	
	.257 Roberts	84M	56	4	13.7	0.54	0.43	22	0.56	10	4	5/4	41.25	
	7mm-08 Rem.	84M	56	4	13.7	0.54	0.43	22	0.56	9	4	5/2	41.25	
	.308 Win.	84M	56	4	13.7	0.54	0.43	22	0.56	10	4	5/2	41.25	
	6.5 Creedmoor	84M	56	4	13.7	0.54	0.43	22	0.56	8	4	5/2	41.25	
	.25-06 Rem.	84L	56	4	13.8	0.54	0.43	24	0.56	10	4	5/10	43.75	
	.270 Win.	84L	56	4	13.8	0.54	0.43	24	0.56	10	4	5/9	43.75	
	.280 Ack. Imp.	84L	56	4	13.8	0.54	0.43	24	0.56	9	4	5/8	43.75	
	.30-06 Sprg.	84L	56	4	13.8	0.54	0.43	24	0.56	10	4	5/7	43.75	
	.270 WSM	8400 SM	56	4	13.5	0.54	0.43	24	0.56	10	3	6/3	43.5	
	.300 WSM	8400 SM	56	4	13.5	0.54	0.43	24	0.56	10	3	6/3	43.5	
.300 Win. Mag.	8400 LM	56	4	13.8	0.54	0.43	26	0.56	10	4	6/13	46.5		
.338 Win. Mag.	8400 LM	56	4	13.8	0.54	0.43	26	0.56	10	4	6/13	46.5		
Adirondack™	7mm-08 Rem.	84M	58	4	13.7	0.54	0.43	18	0.59	9	4	4/13	37.25	
	.308 Win.	84M	58	4	13.7	0.54	0.43	18	0.59	10	4	4/13	37.25	
	.300 AAC Blackout	84M	58	4	13.7	0.54	0.43	16	0.86	7	4	4/13	35.25	
	6.5 Creedmoor	84M	58	4	13.7	0.54	0.43	18	0.59	8	4	4/14	37.25	

Model	Caliber	Action	Page	Footnotes	Stock			Barrel				Magazine capacity	Approx. weight (pounds/ounces) ¹	Overall length (inches)
					Length of pull (inches)	Drop at heel (inches)	Drop at comb (inches)	Barrel length (inches)	Muzzle diameter (inches)	Twist rate (right hand)				
Mountain Ascent™	7mm-08 Rem.	84M	58	2	13.7	0.54	0.43	22	0.56	9	4	4/13	41.25	
	.308 Win.	84M	58	2	13.7	0.54	0.43	22	0.56	10	4	4/13	41.25	
	6.5 Creedmoor	84M	58	2	13.7	0.54	0.43	22	0.56	8	4	4/14	41.25	
	.270 Win.	84L	58	2	13.8	0.54	0.43	24	0.56	10	4	5/7	43.75	
	.280 Ack. Imp.	84L	58	2	13.8	0.54	0.43	24	0.56	9	4	5/6	43.75	
	.30-06 Sprg.	84L	58	2	13.8	0.54	0.43	24	0.56	10	4	5/5	43.75	
	.300 WSM	8400 SM	58	2	13.5	0.54	0.43	24	0.56	10	3	5/12	43.5	
	.270 WSM	8400 SM	58	2	13.5	0.54	0.43	24	0.56	10	3	5/12	43.5	
	.300 Win. Mag.	8400 LM	58	2	13.8	0.54	0.43	26	0.56	10	4	6/7	46.5	
	7mm Rem. Mag.	8400 LM	58	2	13.8	0.54	0.43	26	0.56	9.5	4	6/7	46.5	
Subalpine	.308 Win.	84M	56		13.7	0.54	0.43	22	0.56	10	4	4/13	41.25	
	.280 Ack. Imp.	84L	56		13.8	0.54	0.43	24	0.56	9	4	5/5	43.75	
	.30-06 Sprg.	84L	56		13.8	0.54	0.43	24	0.56	10	4	5/5	43.75	
	.300 WSM	8400 SM	56		13.5	0.54	0.43	24	0.56	10	3	5/12	43.5	
Open Country NEW	.308 Win. Mag.	8400 LM	56		13.8	0.54	0.43	26	0.56	10	4	6/7	46.5	
	6.5 Creedmoor	84M	62		13.8	0.54	0.43	24	0.85	8	4	6/15	43.25	
.308 Win.	84M	62		13.8	0.54	0.43		0.56	10	4				
Varmint	.204 Ruger	84M	64	1	13.8	0.54	0.43	24	0.69	12	6	7/5	43.25	
	.22-250 Rem.	84M	64	1	13.8	0.54	0.43	26	0.69	14	5	7/9	45.25	
LongMaster® Classic™	.223 Rem.	84M	62	1	13.8	0.54	0.43	24	0.69	9	6	7/5	43.25	
	.308 Win.	84M	62	1	13.8	0.54	0.43	24	0.69	10	5	7/5	43.25	
Pro Varmint™	.204 Ruger	84M	64		13.8	0.54	0.43	24	0.85	12	6	8/0	43.25	
	.223 Rem.	84M	64		13.8	0.54	0.43	24	0.85	9	6	8/0	43.25	
	.22-250 Rem.	84M	64		13.8	0.54	0.43	24	0.85	14	5	8/0	43.25	
LongMaster® VT™	.22-250 Rem.	84M	65		14.1	1.75	0.25	26	1.05	14	5	10/0	45.25	
SVT™	.223 Rem.	84M	65		13.8	1.75	0.25	18.25	1.05	9	6	8/5	37.5	
Caprivi™	.375 H&H Mag.	8400 LM	60	1	13.8	0.49	0.59	24	0.7	12	4	8/10	44.5	
	.416 Rem. Mag.	8400 LM	60	1	13.8	0.49	0.59	24	0.7	14	4	8/9	44.5	
	.458 Lott	8400 LM	60	1	13.8	0.49	0.59	24	0.7	14	3	8/8	44.5	
Talkeetna™	.375 H&H Mag.	8400 LM	60		13.8	0.49	0.59	24	0.7	12	4	7/12	44.5	
LPT™	.223 Rem.	84M	66		13.8	0.54	0.43	22	0.85	9	6	8/0	41.25	
	.308 Win.	84M	66		13.8	0.54	0.43	22	0.85	10	5	8/0	41.25	
Patrol Tactical™	.308 Win.	8400 SM	66		13.5	0.43	0.38	24	0.8	10	5	8/12	43.25	
	.300 Win. Mag.	8400 LM	66		13.5	0.43	0.38	26	0.72	10	5	9/9	45.25	
Advanced Tactical™ SRC II NEW	.308 Win.	8400 LM	67	3	13.5	Adjust.	Adjust.	16	0.83	10	5	10/8	37	
Advanced Tactical™ SOC II NEW	.308 Win.	8400 SM	66	3	13.7	Adjust.	Adjust.	22	0.83	10	5	11/8	43	
	6.5 Creedmoor	8400 SM	66	3	13.7	Adjust.	Adjust.	22	0.83	8	5	11/8	43	

FOOTNOTES

- Weight can vary as much as 8 ounces due to natural walnut density.
- Barrel length indicated on Mountain Ascent rifles does not include muzzle brake.
- Advanced Tactical SRC II and Advanced Tactical SOC II rifles are shipped with one (1) 5-round detachable magazine. Additional 5- and 10-round magazines are available as an accessory.
- Adirondack and Montana models have a threaded barrel and ship with a thread protector cap, but do not include a muzzle brake (which is available as an accessory). Adirondack also has a hollowed bolt knob.

RIFLE SPECIFICATIONS CONTINUE TO NEXT PAGE →



RIFLE SPECIFICATIONS

GENERAL INFORMATION

		Classic Select Grade™	SuperAmerica™	Hunter ^{NEW}	Montana™	Adirondack™	Mountain Ascent™	Subalpine	Open Country ^{NEW}	Varmint	LongMaster® Classic™	Pro Varmint™	LongMaster® VT™	SVT™	Caprivi™	Talkeetna™	LPT™	Patrol Tactical™	Advanced Tactical™ SRC II ^{NEW}	Advanced Tactical™ SOC II ^{NEW}	
Material	A walnut									*	*										
	AAA walnut		*																		
	A French walnut	*																			
	AA French walnut														*						
	Reinforced carbon fiber				*	*	*	*	*							*					
	Fiberglass composite																	*			
	Polymer composite			*															*		
	Gray laminated wood												*	*							
	Laminated wood, black epoxy																*				
	Aluminum																		*	*	
Checking	Coverage	Panel	Wrap	None	None	None	None	None	None	Panel	Panel	None	None	None	Wrap	None	None	None	None	None	
	Lines per inch	20	24							20	20				24						
	Stippling			*															*		
Stock	Ebony forend tip	*	*													*					
	Cheekpiece		*												*						
	Hand-rubbed oil finish	*	*							*	*	*	*	*	*						
	Optifade™ Elevated					*															
	Optifade™ Open Country						*		*												
	Optifade™ Subalpine							*													
	Realtree® Edge			*																	
	Kryptek™ Highlander™			*																	
	Granite								*												
	Sniper Gray																			*	
	FDE																		*	*	
	Howell-style inletted rear swivel stud														*						
	Front barrel band swivel stud														*	*					
	Front sling swivel studs	*	*	*	*	*	*	*	*	*	*	*	*	*	*	*	*	*	*	*	
	Additional front swivel stud for bipod								*		*	*	*	*	*	*	*	*	*	*	
	Rear sling swivel studs	*	*	*	*	*	*	*	*	*	*	*	*	*	*	*	*	*	*	*	
	Flush swivel cups (4)																		*		
	Double crossbolts														*						
	Recoil pad thickness (inches)	1	1	1	1	1	1	1	1	0.5	0.5	1	0.5	0.5	1	1	1	1	1	1	
	Pachmayr Decelerator pad	*	*		*	*	*	*	*	*	*	*	*	*	*	*	*	*	*	*	
	Kimber custom recoil pad			*					*												
	Pillar bedding	*	*		*	*	*	*	*	*	*	*	*	*	*	*	*	*	*	*	
	Glass bedding	*	*						*	*	*	*	*	*	*	*	*	*	*	*	
	Aluminum chassis																		*	*	
	Steel grip cap	*	*							*	*	*			*						
	Material	Steel	*	*						*	*	*	*	*	*	*	*	*	*	*	*
		Stainless steel			*	*	*	*	*	*	*	*	*	*	*	*	*	*	*	*	*
Finish		Highly polished blue		*																	
		Matte black	*												*			*	*		
		Satin stainless steel			*	*	*	*	*	*	*	*	*	*	*	*	*	*	*	*	*
		KimPro® II Desert Tan																		*	*
		KimPro® II Gray							*	*	*	*	*	*	*	*	*	*	*	*	*
KimPro® II Black				*															*	*	
Express sights															*	*					
Fluting							*	*	*	*	*	*	*	*	*	*	*	*	*	*	
Muzzle brake						*	*	*	*	*	*	*	*	*	*	*	*	*	*		
Match grade chamber	*	*	*	*	*	*	*	*	*	*	*	*	*	*	*	*	*	*	*		
Material	Steel	*	*						*	*	*	*	*	*	*	*	*	*	*	*	
	Stainless steel			*	*	*	*	*	*	*	*	*	*	*	*	*	*	*	*	*	
	Finish	Matte black	*							*	*	*	*	*	*	*	*	*	*	*	*
		Highly polished blue		*																	
		Satin stainless steel			*	*	*	*	*	*	*	*	*	*	*	*	*	*	*	*	*
		KimPro® II Desert Tan																		*	*
		KimPro® II Gray							*	*	*	*	*	*	*	*	*	*	*	*	*
	KimPro® II Black			*															*	*	
	Type	Front locking repeater	*	*	*	*	*	*	*	*	*	*	*	*	*	*	*	*	*	*	*
		Mauser claw extractor	*	*	*	*	*	*	*	*	*	*	*	*	*	*	*	*	*	*	*
Bolt handle	Sporter	*	*	*	*	*	*	*	*	*	*	*	*	*	*	*	*	*	*	*	
	Fluted, hollowed						*	*	*	*	*	*	*	*	*	*	*	*	*	*	
	Varmint							*	*	*	*	*	*	*	*	*	*	*	*	*	
	Tactical																*	*	*	*	
Trigger	3-position Model 70-type wing safety	*	*	*	*	*	*	*	*	*	*	*	*	*	*	*	*	*	*	*	
	Picatinny base set (2 pieces)																*	*	*	*	
	Picatinny rail, 20 minutes elevation																*	*	*	*	
Trigger	Adjustable	*	*	*	*	*	*	*	*	*	*	*	*	*	*	*	*	*	*	*	
	Factory setting (pull) pounds	3.5-4	3.5-4	3-3.5	3.5-4	3.5-4	3.5-4	3-3.5	3-3.5	3-3.5	3-3.5	3-3.5	3-3.5	3-3.5	3.5-4	3.5-4	3-3.5	3-3.5	2.5	2.5	

GIVING BACK



Camp Guard 10



ROCKY MOUNTAIN ELK FOUNDATION

THE ROCKY MOUNTAIN Elk Foundation (RMEF) is a non-profit land conservation organization, whose mission is to ensure the future of elk, other wildlife, their habitat and America's hunting heritage. Since 1984, the RMEF has helped to conserve more than 6.7 million acres of habitat. RMEF has also helped to restore long-absent elk populations across North America. To support this important conservation organization, Kimber worked with RMEF to design a purpose-built backcountry handgun that combines sought-after personal defense features with the stopping power required for the largest of predators. Kimber is a proud sponsor of RMEF conservation and land access projects.

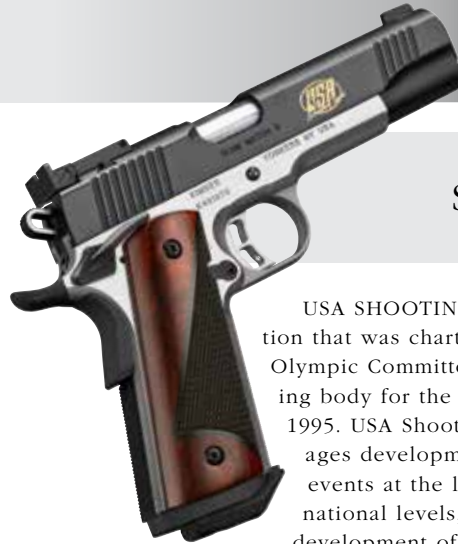

Team Match



USA SHOOTING SPORTS

USA SHOOTING IS a non-profit corporation that was chartered by the United States Olympic Committee as the national governing body for the sport of shooting in April 1995. USA Shooting implements and manages development programs and sanctions events at the local, state, regional, and national levels, as well as oversees the development of U.S. National Teams that compete in international competitions. To support this important organization, Kimber worked with the USA Shooting Rapid Fire Pistol Team to develop a competition handgun for Olympic training purposes. Kimber is a proud sponsor of USA Shooting.

THE BOOT CAMPAIGN

BOOT CAMPAIGN



Hero Custom

Hunter (Boot Campaign)



BOOT CAMPAIGN IS an American non-profit organization that works to provide life-improving programs and initiatives for veterans and military families to bridge the divide between military life and civilian life. Since its inception in 2009, Boot Campaign has raised more than \$19 million, giving more than \$2 million annually to help service members, veterans and their families. To support this important veteran-aligned organization, Kimber partnered with Boot Campaign and co-created both a handgun and a rifle designed to help spread program awareness. Kimber is a proud sponsor of Boot Campaign programs and initiatives.





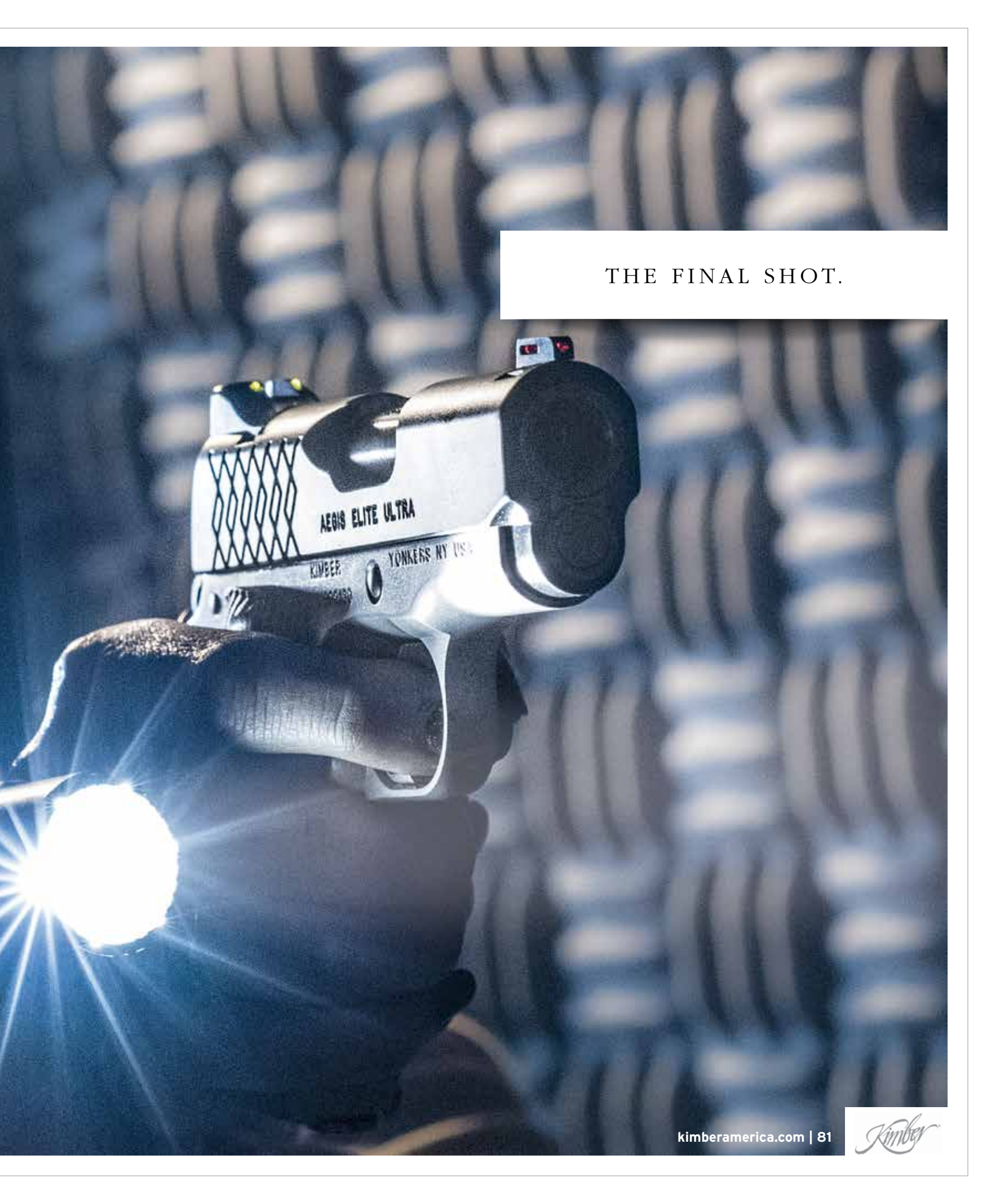

THE FINAL SHOT.



Kimber[®]

WHAT ALL GUNS SHOULD BE.[™]

(888) 243-4522 | kimberamerica.com



MADE IN AMERICA