



**2018**

 **BLACKHAWK!**<sup>®</sup>





## TABLE OF CONTENTS

<b>HOLSTERS &amp; ACCESSORIES</b>	<b>4</b>
Commercial Holsters	4
Commercial Holster Accessories	19
Duty Holsters	20
Duty Holster Accessories	28
<b>ON GUN ACCESSORIES &amp; KINVES</b>	<b>36</b>
Slings	36
Accessories	39
Stocks	48
Suppressors	52
Bi-Pods	54
Knives	56
<b>PACKS &amp; CASES</b>	<b>58</b>
Bags	58
Packs	66
Cases	74
Pouches	80
<b>RIGS &amp; VESTS</b>	<b>102</b>
<b>PROTECTIVE GEAR</b>	<b>122</b>
Gloves	122
Balaclavas	126
Elbow & Knee Pads	126
<b>DYNAMIC ENTRY TOOLS</b>	<b>128</b>
<b>APPAREL, FOOTWEAR, BELTS, &amp; OTHER</b>	<b>140</b>
Apparel	140
Footwear	147
Belts	148
Hats	154
Patches	156
Accessories	157

INJECTION MOLDED POLYMER HOLSTERS

SERPA® CQC® HOLSTERS

- SERPA® Auto Lock™ release
- Passive retention detent adjustment screw
- Speed-cut design for rapid draw, target acquisition and re-holster
- Includes Belt Loop Platform and Paddle Platform
- Fits Shoulder, S.T.R.I.K.E., Quick Disconnect and Tactical Holster Platforms



**MATTE FINISH - BLACK - LEFT HAND**

S&W M&P, Shield 9/.40	410563BK-L
1911 Gov't, & Clones w/ or w/o rail	410503BK-L
Beretta 92/96(, not Elite/Brig.or M9A1)	410504BK-L
Glock, 17/22 /31	410500BK-L
Glock, 19/23/32/36	410502BK-L
Glock, 20/21/37 and S&W MP .45 & Pro 9/40	410513BK-L
Glock, 26/27/33	410501BK-L
Glock, 29/30/39	410530BK-L
H & K USP, Full Size 9/.40	410514BK-L
H & K P30,	410517BK-L
H&K P2000, / USP Compact 9/.40	410509BK-L
S&W 5900, /4000 9/40 series. Incl; TSW	410510BK-L
S&W J-, frame 2" (not .357)	410520BK-L
S&W M&P, 9/.357/.40&SD9/40&Sig(notCORE)	410525BK-L
Sig Pro, 2022	410508BK-L
Sig, 220/225/226/228/229 w,w/o std rail	410506BK-L
Springfield XD	410507BK-L

**MATTE FINISH - OLIVE DRAB - LEFT HAND**

Sig 220/225/226, /P228/P229 w,w/o std rail	410506OD-L
--	------------

**MATTE FINISH - COYOTE TAN - LEFT HAND**

Beretta 92/96(, not Elite/Brig.or M9A1)	410504CT-L
Caracal F (w/o, quick acquisition sight)	410543CT-L
Glock 17/22/31	410500CT-L
H&K USP Full, Size 9/.40	410514CT-L

**CARBON FIBER FINISH - BLACK - LEFT HAND**

1911 Gov't, & Clones w/ or w/o rail	410003BK-L
Ber, 92/96/M9(not Elite/Brig.or M9A1)	410004BK-L
Caracal F, (w/o quick acquisition sight)	410043BK-L
Glock, 17/22 /31	410000BK-L
Glock, 19/23/32/36	410002BK-L
Glock, 20/21/37 and S&W MP .45 & Pro 9/40	410013BK-L
Glock, 26/27/33	410001BK-L
H & K USP, Full Size 9/40	410014BK-L
H&K P2000, /USP Compact 9/.40	410009BK-L
H&K P30,	410017BK-L
Ruger SR9, (not SR22/SR40)	410041BK-L
S&W M&P, 9/.357/.40&SD9/40&Sig(notCORE)	410025BK-L
S&W, 5900/4000 9/40 series. Incl; TSW	410010BK-L
Sig Pro, 2022	410008BK-L
Sig, 220/225/226/228/229 w or w/o rail	410006BK-L
Springfield XD Compact or Service Models	410007BK-L
Springfiled XD Sub-Compact 3" bbl	410031BK-L
Taurus, 24/7 OSS 9/.40 (not G2)	410019BK-L
Walther, P99, S&W SW99	410024BK-L

**CARBON FIBER FINISH - BLACK - RIGHT HAND**

1911 Gov't, & Clones w/ or w/o rail	410003BK-R
Beretta Storm, PX-4 (not sub-compact)	410028BK-R
Beretta 92/96/M9(not Elite/Brig.or M9A1)	410004BK-R

**MATTE FINISH - BLACK - RIGHT HAND**

S&W M&P, Shield 9/.40	410563BK-R
1911 Gov't, & Clones w/ or w/o rail	410503BK-R
1911, Commander & Clones w/ or w/o rail	410542BK-R
Ber 92/96(, not Elite/Brig.or M9A1)	410504BK-R
Beretta, PX4 Storm (not sub-compact)	410528BK-R
Glock 38,	410538BK-R
Glock, 17/22/31	410500BK-R
Glock, 19/23/32/36	410502BK-R
Glock, 20/21/37 and S&W MP .45 & Pro 9/40	410513BK-R
Glock, 20/21/37 and S&W MP .45 & Pro 9/40	410513CT-R
Glock, 20/21/37 and S&W MP .45 & Pro 9/40	410513OD-R
Glock, 26/27/33	410501BK-R
Glock, 29/30/39	410530BK-R
H & K USP, Full Size 9/.40	410514BK-R
H & K P30,	410517BK-R
H&K USP, Compact 9/.40	410509BK-R
H&K, P2000 9/.40 (US)	410516BK-R
Ruger P95,	410512BK-R
Ruger, P85/89	410511BK-R
Ruger SR9, (not SR22/SR40)	410541BK-R
S&W 5900, /4000 9/40 series. Incl; TSW	410510BK-R
S&W J-, frame 2" (not .357)	410520BK-R
S&W M&P, 9/.357/.40&SD9/40&Sig(notCORE)	410525BK-R
Sig, 220/225/226w,w/o std rail	410506BK-R
Sig, 228/229/250DC w,w/o std rail	410505BK-R
SigPro, 2022	410508BK-R
Springfield XD	410507BK-R
Taurus 85, series 2" .38 (some)	410532BK-R
Taurus, 24/7 9/.40 (not G2)	410529BK-R
Taurus, 24/7 OSS 9/.40 (not G2)	410519BK-R
Taurus, Judge (2.5 In Cylinder)	410540BK-R
Taurus, Judge 3" Cylinder	410544BK-R
Walther, P-99, S&W SW99	410524BK-R

**MATTE FINISH - COYOTE TAN - RIGHT HAND**

Beretta 92/96(, not Elite/Brig.or M9A1)	410504CT-R
Caracal F (w/o, quick acquisition sight)	410543CT-R
Glock17/22/31	410500CT-R
H&K USP Full, Size 9/.40	410514CT-R

**MATTE FINISH - FOLIAGE GREEN - RIGHT HAND**

Beretta 92/96(, not Elite/Brig.or M9A1)	410504FG-L
---	------------

**CARBON FIBER FINISH - BLACK - RIGHT HAND (con't)**

Caracal F, (w/o quick acquisition sight)	410043BK-R
ColtCmdr19, 11 & MostClones w,w/o Std Rail	410042BK-R
Glock 38,	410038BK-R
Glock, 17/22 /31	410000BK-R
Glock, 19/23/32/36	410002BK-R
Glock, 20/21/37 and S&W MP .45 & Pro 9/40	410013BK-R
Glock, 26/27/33	410001BK-R
Glock, 29/30/39	410030BK-R
H & K USP, Full Size 9/40	410014BK-R
H&K P30,	410017BK-R
H&K USP, Compact 9/.40	410009BK-R
H&K, P-2000 9/.40 (US)	410016BK-R
Ruger, P85/89	410011BK-R
Ruger SR9, (not SR22/SR40)	410041BK-R
S&W M&P, 9/.357/.40&SD9/40&Sig(notCORE)	410025BK-R
S&W, 5900/4000 9/40 series. Incl; TSW	410010BK-R
Sig, 220/225/226 w/ or w/o rail	410006BK-R
Sig, 228/229/250DC w or w/o rail	410005BK-R
SigPro, 2022	410008BK-R
Springfield XD Compact or Service Models	410007BK-R
Springfield XD Sub-Compact 3" bbl	410031BK-R
Taurus, 24/7 9/.40 (not G2)	410029BK-R
Taurus, 24/7 OSS 9/.40 (not G2)	410019BK-R
Walther, P99, S&W SW99	410024BK-R





## SERPA® CQC® LIGHT-BEARING HOLSTERS

- SERPA® Auto Lock™ release
- Passive retention detent adjustment screw
- Speed-cut design for rapid draw, target acquisition and re-holster
- Includes Belt Loop Platform and Paddle Platform
- Requires Night-Ops® Xiphos™ NTX Weapon Mounted Light (sold separately)
- Fits Shoulder, S.T.R.I.K.E., Quick Disconnect and Tactical Holster Platforms

### MATTE FINISH - BLACK - RIGHT or LEFT HAND

1911, Gov't & Clones w/or w/orail	414503BK-R
Glock 17/22/31	414500BK-L or R
Sig 220/226/228/229 w or w/o rail	414506BK-L or R



## OMNIVORE™ HOLSTERS

DESIGNED TO FIT MORE THAN

**150**

STYLES OF SEMI-AUTO HANDGUNS  
WITH AN ACCESSORY RAIL

- OMNIVORE™ Holsters fit more than 150 styles of semi-automatic handguns with an accessory rail.
- Ergonomic thumb-activated retention mechanism delivers instant firearm access.
- Uses two features to hold handgun securely in place.
- Holster locks onto Rail Attachment Device (Non-LB) or frame of the light, doesn't wear



OMNIVORE™ NON-LIGHT BEARING

### OMNIVORE™ NON-LIGHT BEARING

OMNIVORE Black/Grey Non light	419000BUL
OMNIVORE Black/Grey Non light	419000BUR
OMNIVORE Black/Tan Non light	419000BCL
OMNIVORE Black/Tan Non light	419000BCR

### OMNIVORE™ SUREFIRE X300U-A/B

OMNIVORE Black/Grey Surefire, X300A	419001BUL
OMNIVORE Black/Grey Surefire, X300A	419001BUR
OMNIVORE Black/Tan Surefire, X300A	419001BCL
OMNIVORE Black/Tan Surefire, X300A	419001BCR

### OMNIVORE™ STREAMLIGHT TLR-1/2

OMNIVORE Black/Grey, Streamlight TLR 1/2	419002BUL
OMNIVORE Black/Grey, Streamlight TLR 1/2	419002BUR
OMNIVORE Black/Tan, Streamlight TLR 1/2	419002BCL
OMNIVORE Black/Tan, Streamlight TLR 1/2	419002BCR



OMNIVORE™ STREAMLIGHT TLR-1/2



OMNIVORE™ SUREFIRE X300U-A/B

## A.R.C. IWB HOLSTERS

- Soft, durable injection-molded material designed for comfort
- Fully ambidextrous design allows for left- and right-handed use
- Designed for both civilian and law enforcement concealed carry
- Packaged with two can't and ride height adjustment belt clips for 1.5- and 1.75-inch belts
- Allows for use of rear-mounted red dot sights

### URBAN GRAY - AMBIDEXTROUS

Glock 17/22/31	417500UG
Glock 19/23/32	417502UG
Glock 42	417567UG
Glock 43, Kahr PM9/40	417568UG
S&W M&P Shield, Shield 2.0	417563UG
S&W M&P, M&P 2.0	417525UG
Springfield XD/MOD2/XDM	417507UG
Ruger, LC380/LC9	417549UG
S&W, J-Frame	417520UG
Springfield, XDS 3.3/4.0	417565UG



## NEW! KYDEX IWB AND IWB/OWB HOLSTERS

- Pliable Kydex construction and flexible backing on IWB/OWB and OWB models for ultimate comfort
- Available in three configurations, including combination IWB/OWB
- Belt mount on IWB and IWB/OWB moves to fit user preference
- Designed to maximize concealability and comfort

### INSIDE WAIST BAND - BLACK - LEFT OR RIGHT HAND

Glock 43/Kahr, P9/40, K9/40,PW/CW 9/40, CM/PM 9/40	481468BKL or R
Glock, 19/23/26/27/32/33	481402BKL or R
S&W M&P 4", & Cmpt 9/40 not 2.0 mod	481425BKL or R
S&W M&P, Shield 9/40	481463BKL or R
Sig 238	481434BKL or R
Sig 320, Fullsize & Compact	481461BKL or R

### INSIDE OR OUTSIDE WAIST BAND - BLACK - LEFT OR RIGHT HAND

Glock 43/Kahr, P9/40, K9/40,PW/CW 9/40, CM/PM 9/40	482068BKL or R
Glock, 19/23/26/27	482002BKL or R
S&W M&P, Fullsize and Compact	482025BKL or R
S&W M&P, Shield 9/40	482063BKL or R
Sig 238	482034BKL or R
Sig 320, Fullsize/Compact	482061BKL or R

### OUTSIDE WAIST BAND - BLACK - LEFT OR RIGHT HAND

Glock, 17/22/31	480000BKL or R
Glock, 19/23/26/27	480002BKL or R
S&W M&P, Full & Compact 9/40	480025BKL or R





## SERPA STANDARD HOLSTERS

- Passive retention detent adjustment screw aids in weapon retention
- Aids in rapid draw, target acquisition and re-holster
- Fits Shoulder, S.T.R.I.K.E., Quick Disconnect and Tactical Holster Platforms

### MATTE FINISH - BLACK - RIGHT HAND

M&P .45/9/40 Pro RH	415645BK-R
Ruger LC9/LC380 w/o laser	415649BK-R
S&W M&P Shield 9/.40	415663BK-R
Glock 26/27/33	415601BK-R
H&K USP Compact 9/.40	415609BK-R
Glock 17/22/31	415600BK-R
Glock 19/23/32/36	415602BK-R
Glock, 20/21/37, S&W M&P.45&9/.40 Pro	415613BK-R
S&W MP, 9/40 &SD9/40 & Sigma(notCORE)	415625BK-R
Springfield XD 4" and XDM 3.8"-4" bbl	415607BK-R
Colt, 1911 Cmdr/Clones w, w/o std rail	415642BK-R
Beretta, 92/96/M9(notElite/Brig. or M9A1)	415604BK-R
Sig, 228/229/250DCc w or w/o rail	415605BK-R
Glock 29/30/39 RH	415630BK-R
Ruger SR9/SR40 (not SR22)	415641BK-R
Sig, 220/225/226 w/ or w/o rail	415606BK-R



### MATTE FINISH - BLACK - LEFT HAND

Glock 17/22/31	415600BK-L
Glock 26/27/33	415601BK-L
S&W M&P Shield 9/.40	415663BK-L
Glock 19/23/32/36	415602BK-L

## SERPA SPORTSTER HOLSTERS

- Passive retention detent adjustment screw aids in weapon retention
- Aids in rapid draw, target acquisition and re-holster
- Includes paddle platform only
- Fits Shoulder, S.T.R.I.K.E., Quick Disconnect and Tactical Holster Platforms

### RIGHT HAND

1911 Gov't/, Clones w/or w/o rail	413503BK-R
Beretta 92/96/M9(not Elite/Brig.orM9A1)	413504BK-R
Glock 20/21/37, /M&P.45-Pro 9/40	413513BK-R
Glock, 17/22/31	413500BK-R
Glock, 19/23/32/36	413502BK-R
Glock, 26/27/33	413501BK-R
H & K USP, Full Size 9/40	413514BK-R
H&K P2000, 9/.40 (US)	413516BK-R
H&K USP, Compact 9/.40	413509BK-R
S&W M&P, 9/40 & Sigma (not CORE)	413525BK-R
S&W, 5900/4000 9/40 Incl-TSW	413510BK-R
Sig, 220/225/226 w/or w/o std rail	413506BK-R
Sig, 228/229/250DC w or w/o std rail	413505BK-R
Springfield, XD Comp/Srvc Models	413507BK-R



### LEFT HAND

1911 Gov't/, Clones w/or w/o rail	413503BK-L
Ber, 92/96/M9(not Elite/Brig.or M9A1)	413504BK-L
Glock 20/21/37, /M&P.45-Pro 9/40	413513BK-L
Glock, 17/22/31	413500BK-L
Glock, 19/23/32/36	413502BK-L
Glock, 26/27/33	413501BK-L
H & K USP, Full Size 9/40	413514BK-L
H&K P2000 /, USP Compact 9/.40	413509BK-L
S&W M&P, 9/40 & Sigma (not CORE)	413525BK-L
S&W, 5900/4000 9/40 Incl-TSW	413510BK-L
Sig, 220/226/228/229 w or w/o std rail	413506BK-L

LEATHER HOLSTERS

**NEW! PREMIUM LEATHER HOLSTERS - INSIDE THE PANT**

- Selected from the best hides to provide the most comfortable, longest lasting leather holster available
- Hand-formed and finished to meet demanding quality standards
- Hand-craftsmanship ensures an individualized finish on each holster
- Covered trigger guard ensures safe carry
- Leather snapable belt loop



Antiqued Brown

Make/Model	Color	Part Number
Beretta 92/96	Antiqued Brown	450404ABL or R
Beretta 92/96	Burnished Brown	450404BBL or R
Beretta Storm PX-4	Antiqued Brown	450422ABL or R
Beretta Storm PX-4	Burnished Brown	450422BBL or R
Colt 1911 4" w/w/o rls	Antiqued Brown	450442ABL or R
Colt 1911 4" w/w/o rls	Burnished Brown	450442BBL or R
Colt Comm w/w/o rail	Burnished Brown	450442BBL or R
Colt Comm w/w/o rails	Antiqued Brown	450442ABL or R
FNH, FNS/FNX 9/.40	Antiqued Brown	450464ABL or R
FNH, FNS/FNX 9/.40	Burnished Brown	450464BBL or R
G43, Kahr CW9/40,P9/40,K9/40	Antiqued Brown	450468ABL or R
G43, Kahr CW9/40,P9/40,K9/40	Burnished Brown	450468BBL or R
Glock, 17/19/22/23/31/32/36	Antiqued Brown	450400ABL or R
Glock, 17/19/22/23/31/32/36	Burnished Brown	450400BBL or R
Glock 26/27/33	Antiqued Brown	450401ABL or R
Glock 26/27/33	Burnished Brown	450401BBL or R
Glock, 42	Antiqued Brown	450467ABL or R
Glock, 42	Burnished Brown	450467BBL or R
HK, P2000/USP Cmpt	Antiqued Brown	450409ABL or R
HK, P2000/USP Cmpt	Burnished Brown	450409BBL or R
HK, VP9/40	Antiqued Brown	450479ABL or R
HK, VP9/40	Burnished Brown	450479BBL or R
Kimber, K6	Antiqued Brown	450448ABL or R
Kimber, K6	Burnished Brown	450448BBL or R
Kimber, Micro 380	Antiqued Brown	450456ABL or R
Kimber, Micro 380	Burnished Brown	450456BBL or R
Kimber, Micro 9	Burnished Brown	450446BBL or R
Kimber, Micro 9	Antiqued Brown	450446ABL or R
Ruger, LC9/LC380	Antiqued Brown	450449ABL or R
Ruger, LC9/LC380	Burnished Brown	450449BBL or R
Ruger, LCP II	Antiqued Brown	450454ABL or R
Ruger, LCP II	Burnished Brown	450454BBL or R
Ruger, LCR	Antiqued Brown	450436ABL or R
Ruger, LCR	Burnished Brown	450436BBL or R
Sig 238	Antiqued Brown	450426ABL or R
Sig 238	Burnished Brown	450426BBL or R
Sig 938	Antiqued Brown	450427ABL or R
Sig 938	Burnished Brown	450427BBL or R
Sig, 220/225/226/228/229	Antiqued Brown	450406ABL or R
Sig, 220/225/226/228/229	Burnished Brown	450406BBL or R
Sig, P250/P320 & Compact	Burnished Brown	450461BBL or R
Sig, P250/P320 andCompact	Antiqued Brown	450461ABL or R
Springfield XD 4"	Antiqued Brown	450407ABL or R
Springfield XD 4"	Burnished Brown	450407BBL or R
Springfield XDS 3.3"	Antiqued Brown	450465ABL or R
Springfield XDS 3.3"	Burnished Brown	450465BBL or R
Springfld XD Sub Cmpt	Antiqued Brown	450431ABL or R
Springfld XD Sub Cmpt	Burnished Brown	450431BBL or R
S&W J, Frame/Taurus 85	Burnished Brown	450420BBL or R
S&W J, Frame/Taurus 85	Antiqued Brown	450420ABL or R
S&W M&P Shield 9/.40	Antiqued Brown	450463ABL or R
S&W M&P Shield 9/.40	Burnished Brown	450463BBL or R
S&W MP 9/40 4" & Cmpt	Antiqued Brown	450425ABL or R
S&W MP 9/40 4" & Cmpt	Burnished Brown	450425BBL or R
S&W M&P, Shield 45	Burnished Brown	450451BBL or R
S&W M&P, Shield 45	Antiqued Brown	450451ABL or R
S&W M&P, Shield 9/.40	Antiqued Brow	450463ABL or R
S&W M&P, Shield 9/.40	Burnished Brown	450463BBL or R
S&W, Bodyguard .38	Antiqued Brown	450452ABL or R
S&W, Bodyguard .38	Burnished Brown	450452BBL or R
S&W, Bodyguard .380	Antiqued Brown	450453ABL or R
S&W, Bodyguard .380	Burnished Brown	450453BBL or R







**NEW! PREMIUM LEATHER HOLSTERS - 3 SLOT PANCAKE**

- Hand-formed and finished to meet demanding quality standards.
- Hand-craftsmanship ensures an individualized finish on each holster.
- High inner-body provides moisture barrier and protects body from sharp edges.
- Reinforced thumb break adds ease of draw, longevity.
- Three-slot design allows for behind the hip, strong-side, cross-draw or appendix carry.

Make/Model	Color	Part Number
Beretta 92/96	Antiqued Brown	450004ABL or R
Beretta 92/96	Burnished Brown	450004BBL or R
Colt 1911 4" Comm	Antiqued Brown	450042ABL or R
Colt 1911 4" Comm	Burnished Brown	450042BBL or R
Colt 1911 5"	Burnished Brown	450003BBL or R
Colt 1911 5"	Antiqued Brown	450003ABL or R
CZ 75/85 FS/Cmpt	Antiqued Brown	450062ABL or R
CZ 75/85 FS/Cmpt	Burnished Brown	450062BBL or R
Glock 17/22/31	Antiqued Brown	450000ABL or R
Glock 17/22/31	Burnished Brown	450000BBL or R
Glock 19/23/32/36	Burnished Brown	450002BBL or R
Glock 19/23/32/36	Antiqued Brown	450002ABL or R
HK VP 9/40	Burnished Brown	450079BBL or R
HK VP9/40	Antiqued Brown	450079ABL or R
Sig P250/320	Burnished Brown	450061BBL or R
Sig P250/320	Antiqued Brown	450061ABL or R
S&W J Frm/Taur 85	Antiqued Brown	450020ABL or R
S&W J Frm/Taur 85	Antiqued Brown	450020BBL or R
S&W M&P 9/40 4" & Cmpt	Antiqued Brown	450025ABL or R
S&W M&P 9/40 4" & Cmpt	Burnished Brown	450025BBL or R
Springfield XD/XDM 4"	Antiqued Brown	450007ABL or R
Springfield XD/XDM 4"	Burnished Brown	450007BBL or R



Antiqued Brown

**NEW! PREMIUM LEATHER MAGAZINE POUCH**

- Selected from the best hides to provide the longest lasting leather mag pouches available
- Hand-formed and finished to meet demanding quality standards
- Hand-craftsmanship ensures an individualized finish on each holster

Single Stack Mag Pouch	Color	Part Number
Compact, Single Stack Magazine Pouch	Antiqued Brown	45CS03AB
Compact, Single Stack Magazine Pouch	Burnished Brown	45CS03BB
Single Stack, Magazine Pouch	Antiqued Brown	45SS01AB
Single Stack, Magazine Pouch	Burnished Brown	45SS01BB

Double Stack Mag Pouch	Color	Part Number
Compact, Double, Stack Magazine Pouch	Antiqued Brown	45CD02AB
Compact, Double Stack Magazine Pouch	Burnished Brown	45CD02BB
Double Stack, Magazine Pouch	Antiqued Brown	45DS01AB
Double Stack, Magazine Pouch	Burnished Brown	45DS01BB



Antiqued Brown



## NYLON HOLSTERS

### TECGRIP® IWB HOLSTERS

- Designed for both civilian and law enforcement concealed carry
- Proprietary gripping material allows for clipless inside-the-waistband carry
- Fully ambidextrous design for left- and right-handed use
- Shirt Shield protects firearm from body
- Washable with soap and water; air dry

Part Number	Model	Size
40IP00CT	2" – 3" Barrel Small/Medium Double-Action Revolvers (Except 2" 5-Shot)	00
40IP01CT	3" – 4" Barrel Medium-Frame .32/.380 Autos	01
40IP02CT	4" Barrel Medium and Intermediate Double-Action Revolvers	02
40IP03CT	4.5" – 5" Barrel Large Autos	03
40IP04CT	Small Autos (.22/.25) and Very Small-Frame .32 and .380s	04
40IP05CT	Glock 26/27/33/43, M&P Shield 9/40 and other Sub-Compact 9/.40	05
40IP06CT	3.75" – 4.5" Barrel Large Autos	06
40IP07CT	3.25" – 3.75" Barrel Medium/Large Autos	07
40IP08CT	2" Barrel Small-Frame 5-Shot Revolvers, Small-Frame .380s with Crimson Trace	08



### TECGRIP® POCKET HOLSTERS

- Designed for both civilian and law enforcement concealed carry
- Proprietary gripping material secures holster in any pocket
- Ambidextrous design for left- and right-handed use
- Washable with soap and water; air dry

Part Number	Model	Size
40TP01CT	Small Autos (.22/.25)	01
40TP02CT	Most Small-Frame .380s	02
40TP03CT	2" 5-Shot Ruger, Kel-Tec, Kahr and Taurus .380	03
40TP04CT	Glock 43, M&P Shield 9/40, most Sub-Compact 9/.40 Autos	04



### NEW! TECGRIP® MAG POUCHES

- Proprietary gripping material secures magazine in any pocket
- Ambidextrous design for left- and right-handed use
- Washable with soap and water; air dry

Part Number	Model
40MP01CT	Single Stack Full Size & Compact
40MP02CT	Double Stack Full Size & Compact



Single Stack



Double Stack

### NYLON VERTICAL SHOULDER HOLSTER

- Constructed of 1000 denier CORDURA® nylon outer material
- CORDURA® nylon outer shell and waterproof closed-cell foam padding
- Offside tie-down with dual Picatinny rail platform for accessories
- Adjustable, non-stretch retention strap with molded finger break
- Fits handguns with scopes (40SV) or without scopes (40VH)



**WITHOUT SCOPE**

Part Number	Color	Model	Size
40VH00BK-R or L	Black	2" – 3" Barrel Small/Medium Double-Action Revolvers (Except 2" 5-Shot)	00
40VH01BK-R or L	Black	3" – 4" Barrel Medium Autos and 3.25" – 3.75" Barrel Large Autos (.32/.380)	01
40VH02BK-R or L	Black	4" Barrel Medium/Large Double-Action Revolvers	02
40VH03BK-R or L	Black	5" – 6.5" Barrel Medium/Large Double-Action Revolvers and 4.625" – 5.25" Barrel Single-Action Revolvers	03
40VH04BK-R or L	Black	7" – 8.5" Barrel Medium/Large Double-Action Revolvers and 6" – 7.5" Barrel Single-Action Revolvers	04
40VH05BK-R or L	Black	4.5" – 5" Barrel Large Autos, Open End (Safety Strap Rotates to Secure Autos on Grip or Hammer)	05
40VH06BK-R or L	Black	5.5" – 6" Barrel .22 Autos and Airguns	06
40VH11BK-R or L	Black	9.5" – 10.75" Barrel Single- and Double-Action Revolvers	11
40VH12BK-R or L	Black	10" Barrel T/C Contenders	12
40VH13BK-R or L	Black	14" and 16" Barrel T/C Super Contenders, Encore and 10" Barrel Remington XP-100	13
40VH15BK-R or L	Black	3.75" – 4.5" Barrel Large Autos	15

**WITH SCOPE**

Part Number	Color	Model	Size
40SV03BK-R or L	Black	5" – 6.5" Barrel Medium/Large Double-Action and 4.625" – 5.25" Barrel Single-Action Revolvers	03
40SV04BK-R or L	Black	6" – 8.5" Barrel Medium/Large Double-Action and 6" – 8.5" Barrel Single-Action Revolvers and 10" Barrel T/C Contenders	04
40SV13BK-R or L	Black	14" and 16" Barrel T/C Super Contenders, Encore and 10V Barrel Remington XP-100, and 9.5" – 10.75" Barrel Single & Double-Action Revolvers	13



### NYLON HORIZONTAL SHOULDER HOLSTER

- Constructed of 1000 denier CORDURA® nylon outer material
- Offside plate for optional accessories
- Non-stretch retention strap with molded thumb break

Part Number	Color	Model	Size
40HS00BK MD or LG	Black	2" – 3" Barrel Small/Medium Double-Action Revolvers (Except 2" 5-Shot)	00
40HS01BK MD or LG	Black	3" – 4" Barrel Medium-Frame .32/.380 Autos	01
40HS02BK MD or LG	Black	4" Barrel and Intermediate Double-Action Revolvers	02
40HS05BK MD or LG	Black	4.5" – 5" Barrel Large Autos	05
40HS15BK MD or LG	Black	3.75" – 4.5" Barrel Large Autos	15
40HS16BK MD or LG	Black	3.25" – 3.75" Barrel Medium/Large Autos	16
40HS36BK MD or LG	Black	2" Barrel Small-Frame 5-Shot Revolvers with Hammer Spur	36



### NYLON BEDSIDE HOLSTER

- Ambidextrous design
- Constructed of 1000 denier CORDURA® nylon outer material
- Mounting platform slips between mattress and box springs
- Holds pistol beside bed for rapid access
- Works with revolvers and semi-autos (without under barrel lights/lasers)
- Non-slip material on mounting platform for added stability
- Universal-fit holster accommodates most handguns



Part Number	Color	Description
40BH00BK	Black	Nylon Bedside Holster

### NYLON HIP HOLSTER WITH THUMB BREAK

- Constructed of 1000 denier CORDURA® nylon outer material
- Laminate construction for waterproof protection
- Dual-slot belt loops for duty, sport or dress belts

Part Number	Color	Model	Size
40HT00BK-R or L	Black	2" – 3" Barrel Small/Medium Double-Action Revolvers (Except 2" 5-Shot)	00
40HT01BK-R or L	Black	3" – 4" Barrel Medium-Frame .32/.380 Autos	01
40HT02BK-R or L	Black	4" Barrel Medium and Intermediate Double-Action Revolvers	02
40HT03BK-R or L	Black	6" Barrel Medium and Intermediate Double-Action Revolvers	03
40HT05BK-R or L	Black	4.5" – 5" Barrel Large Autos	05
40HT15BK-R or L	Black	3.75" – 4.5" Barrel Large Autos	15
40HT16BK-R or L	Black	3.25" – 3.75" Barrel Medium/Large Autos	16
40HT19BK-R or L	Black	Colt Gov't Large Autos and Browning Hi-Power	19
40HT21BK-R or L	Black	Glock 17/19/20/21/22/23/29/36	21
40HT36BK-R or L	Black	2" Barrel Small-Frame 5-Shot Revolvers with Hammer Spur	36



### NYLON PADDLE HOLSTER

- Constructed of 1000 denier CORDURA® nylon outer material
- Paddle adjusts for vertical, butt-forward or muzzle-forward carry

Part Number	Color	Model	Size
40PH00BK-R	Black	2" – 3" Barrel Small/Medium Double-Action Revolvers (Except 2" 5-Shot)	00
40PH01BK-R	Black	3" – 4" Barrel Medium-Frame .32/.380 Autos	01
40PH02BK-R	Black	4" Barrel and Intermediate Double-Action Revolvers	02
40PH05BK-R	Black	4.5" – 5" Barrel Large Autos	05
40PH15BK-R	Black	3.75" – 4.5" Barrel Large Autos	15
40PH16BK-R	Black	3.25" – 3.75" Barrel Medium/Large Autos	16
40PH19BK-R	Black	Colt Gov't Large Autos and Browning Hi-Power	19
40PH21BK-R	Black	Glock 17/19/20/21/22/23/29/30	21
40PH36BK-R	Black	2" Barrel Small-Frame 5-Shot Revolvers with Hammer Spur	36



### NYLON UNIVERSAL SPEC OPS PISTOL HARNESS

- For cross-body in the vertical, horizontal or angled position
- Constructed of 1000 denier CORDURA® nylon outer material
- Padded and fully adjustable
- Fits most semi-auto pistols
- Right-hand model only



Part Number	Color	Description
40SH04BK	Black	Nylon Universal Spec Ops Pistol Harness

### NYLON 3-SLOT PANCAKE HOLSTER

- Gives the option of strong-side, kidney or crossdraw mounting options
- A reversible/adjustable retention strap with molded thumb break provides reliable weapon security
- Ambidextrous design
- Constructed of 1000 denier CORDURA® nylon outer material
- Lined with smooth, snag-resistant material
- Belt slots pull holster body close for maximum concealment
- Fits belts up to 1.75" wide



Part Number	Color	Model	Size
40PC00BK	Black	2" - 3" Barrel Small/Medium Double-Action Revolvers (Except 2" 5-Shot)	00
40PC01BK	Black	3" - 4" Barrel Medium-Frame .32/.380 Autos	01
40PC02BK	Black	4" Barrel Medium and Intermediate Double-Action Revolvers	02
40PC03BK	Black	4.5" - 5" Barrel Large Autos	03
40PC04BK	Black	Glock 26/27/33 and other Sub-Compact 9/.40	04
40PC05BK	Black	3.75" - 4.5" Barrel Large Autos	05
40PC06BK	Black	3.25" - 3.75" Barrel Medium/Large Autos	06
40PC36BK	Black	2" Barrel Small-Frame 5-Shot Revolvers with Hammer Spur	36

### NYLON TASER® C2 HOLSTER

- Constructed of 1000 denier CORDURA® nylon outer material with 1/8" padding
- Retention strap with snap thumb break
- Molded belt loop
- Weight: 1.6 oz.
- Fits Civilian TASER® C2



Part Number	Color	Model
40C200BK	Black	TASER®C2

### NYLON LASER HOLSTER

- Carries popular-sized pistols with most under-barrel laser systems
- Constructed of 1000 denier CORDURA® nylon outer material

Part Number	Color	Model	Size
40LH01BK	Black	3" - 4" BBL Medium Autos with Most Under-Barrel Lasers	01
40LH02BK	Black	3.25" - 3.75" BBL Medium/Large-Frame Autos with Most Under-Barrel Lasers	02
40LH03BK	Black	Gov't 1911 with Most Under-Barrel Lasers	03







## NYLON HIP HOLSTER

- Constructed of 1000 denier CORDURA® nylon outer material
- Smooth nylon lining for easy draw
- Adjustable retention strap with non-glare snaps

Part Number	Color	Model	Size
73NH00BK-R or L	Black	2" – 3" Barrel Small/Medium Double-Action Revolvers (Except 2" 5-Shot)	00
73NH01BK-R or L	Black	3" – 4" Barrel Medium .32/.380 Frame .32/.380 Autos	01
73NH02BK-R or L	Black	3" – 4" Barrel Medium/Large Double-Action Revolvers	02
73NH03BK-R or L	Black	5" – 6.5" Barrel Medium/Large Double-Action Revolvers	03
73NH04BK-R or L	Black	4.5" – 5" Barrel Large Autos, Open End	04
73NH05BK-R or L	Black	Small Autos (.22/.25) and Very Small-Frame .32 and .380s	05
73NH06BK-R or L	Black	Glock 26/27/33 and other Sub-Compact 9/.40	06
73NH07BK-R or L	Black	3.5" – 4.5" Barrel Large Autos, Open End	07
73NH08BK-R or L	Black	3.25" – 3.75" Barrel Medium/Large Autos	08
73NH09BK-R or L	Black	2" Small-Frame 5-Shot Revolvers with Hammer Spur	09
73NH10BK-R or L	Black	7" – 8.5" Barrel Medium/Large Double-Action Revolvers (Tie-Down Loop Included)	10
73NH11BK-R or L	Black	9.5" – 10.75" Barrel Single- and Double-Action Revolvers (Tie-Down Loop Included)	11
73NH12BK-R or L	Black	3" – 5" Barrel Single-Action Revolvers	12
73NH13BK-R or L	Black	5.5" – 6.5" Barrel Single-Action Revolvers	13
73NH14BK-R or L	Black	6.875" Barrel .22 Autos	14
73NH15BK-R or L	Black	6.5" – 7.5" Barrel Single-Action Revolvers	15
73NH16BK-R or L	Black	5.5" – 6" Barrel .22 Autos and Airguns	16
73NH17BK-R or L	Black	10.5" Barrel .22 Autos (Tie-Down Loop Included)	17
73NH18BK-R or L	Black	6" Raging Bull and 6" S&W N-Frame Full Lug	18
73NH19BK-R or L	Black	8" Raging Bull and 8.375" S&W N-Frame Full Lug	19



## SPORTSTER® AMBIDEXTROUS HOLSTER WITH MAG POUCH

- Constructed of durable 600 denier polyester
- Wear inside pants or on belt
- Reversible thumb break and dual belt loops for right- or left-handed use
- Removable spring-steel clip secures holster to waistband for inside-the-pants wear
- Includes built-in spare mag pouch (B990262 does not include mag pouch)

Part Number	Color	Model	Size
B990262BK	Black	4" Barrel Med/Inter Double Action Revolver (S&W 64/66, Taurus 66/Judge, Ruger GP-100)	02
B990263BK	Black	4.5-5" Barrel Large Auto (Beretta 92/96, Colt 1911)	03



## SPORTSTER® 3-SLOT PANCAKE HOLSTER

- Ambidextrous design with reversible/adjustable retention strap and thumb break
- Three-slot design for strong-side, kidney or cross-draw mount options
- Belt slots pull holster body close for better concealment
- Lined with a smooth, snag-resistant material
- Fits belts up to 1.75" wide

Part Number	Color	Model	Size
B990261BK	Black	3.75-4.5" Barrel Large Autos (Glock 17/22, Smith M&P, Ruger SR9, Sig 229)	05



## INSIDE-THE-PANTS HOLSTER

- Constructed of soft laminate suede-like outer material
- Smooth nylon lining for easy draw
- Belt clip slips over pants or belt to retain holster
- Fold-over hook & loop retention strap (73IR0 only)



Without retention strap



With retention strap

Part Number	Color	Model	Size
73IP00BK	Black	2" – 3" Barrel Small/Medium Double-Action Revolvers (Except 2" 5-Shot)	00
73IP00BK-L	Black	2" – 3" Barrel Small/Medium Double-Action Revolvers (Except 2" 5-Shot)	00
73IP01BK	Black	3" – 4" Barrel Medium-Frame .32/.380 Autos	01
73IP01BK-L	Black	3" – 4" Barrel Medium-Frame .32/.380 Autos	01
73IP02BK	Black	4" Barrel Medium and Intermediate Double-Action Revolvers	02
73IP02BK-L	Black	4" Barrel Medium and Intermediate Double-Action Revolvers	02
73IP03BK	Black	4.5" – 5" Barrel Large Autos	03
73IP03BK-L	Black	4.5" – 5" Barrel Large Autos	03
73IP04BK	Black	Small Autos (.22/.25) and Very Small-Frame .32 and .380s	04
73IP04BK-L	Black	Small Autos (.22/.25) and Very Small-Frame .32 and .380s	04
73IP05BK	Black	Glock 26/27/33 and other Sub-Compact 9/.40	05
73IP05BK-L	Black	Glock 26/27/33 and other Sub-Compact 9/.40	05
73IP06BK	Black	3.75" – 4.5" Barrel Large Autos	06
73IP06BK-L	Black	3.75" – 4.5" Barrel Large Autos	06
73IP07BK	Black	3.25" – 3.75" Barrel Medium/Large Autos	07
73IP07BK-L	Black	3.25" – 3.75" Barrel Medium/Large Autos	07
73IP08BK	Black	2" Barrel Small-Frame 5-Shot Revolvers, Small-Frame .380s with Crimson Trace	08
73IP08BK-L	Black	2" Barrel Small-Frame 5-Shot Revolvers, Small-Frame .380s with Crimson Trace	08
<b>With Retention Strap</b>			
73IR00BK-R or L	Black	2" – 3" Barrel Small/Medium Double-Action Revolvers (Except 2" 5-Shot)	00
73IR01BK-R or L	Black	3" – 4" Barrel Medium-Frame .32/.380 Autos	01
73IR02BK-R	Black	4" Barrel Medium and Intermediate Double-Action Revolvers	02
73IR03BK-R	Black	4.5" – 5" Barrel Large Autos	03
73IR06BK-R or L	Black	3.75" – 4.5" Barrel Large Autos	06
73IR07BK-R or L	Black	3.25" – 3.75" Barrel Medium/Large Autos	07
73IR08BK-R or L	Black	2" Barrel Small-Frame 5-Shot Revolvers, Small-Frame .380s with Crimson Trace	08



## NYLON ANKLE HOLSTER

- Constructed of 1000 denier CORDURA® nylon outer material
- Closed-cell foam padding protects pistol from moisture
- Non-stretch retention strap with molded thumb break

Part Number	Color	Model	Size
40AH00BK-R or L	Black	2" Barrel Small-Frame 5-Shot Revolvers with Hammer Spur	00
40AH01BK-R or L	Black	3" – 4" Barrel Medium-Frame .32/.380 Autos	01
40AH10BK-R or L	Black	Small Autos (.22/.25) and Very Small-Frame .32 and .380s	10
40AH12BK-R or L	Black	Glock 26/27/33 and other Sub-Compact 9/.40	12
40AH16BK-R or L	Black	3.25" - 3.75" Barrel Medium/Large Autos	16



## NYLON AMBIDEXTROUS MULTI-USE HOLSTER

- Constructed of 1000 denier CORDURA® nylon outer material
- Removable spring-steel clip
- Reversible, non-stretch hook & loop retention strap with molded thumb break
- Fits belts up to 1.75" wide in a traditional vertical position
- Fits belts up to 1.5" wide in horizontal position (middle of the back)
- Holsters for semi-auto pistols include spare mag pouch with adjustable retention flap

Part Number	Color	Model	Size
40AM01BK	Black	3" – 4" Barrel Medium-Frame .32/.380 Autos	01
40AM02BK	Black	4" Barrel Medium/Large Double-Action Revolvers	02
40AM03BK	Black	4.5" – 5" Barrel Large Autos	03
40AM05BK	Black	3.75" – 4.5" Barrel Large Autos	05
40AM06BK	Black	3.25" - 3.75" Barrel Medium/Large Autos	06
40AM36BK	Black	2" – 2.25" Small-Frame 5- and 6-Shot Revolvers with Hammer Spur	36



## NYLON BELT POUCH HOLSTER

- Constructed of 1000 denier CORDURA® nylon outer material
- Top zipper opening can remain open or closed without revealing weapon
- Discreet hook & loop flap inside pouch keeps handgun hidden
- Separate pocket on front of pouch holds keys, cuffs, camera, company patch or other items
- Dual belt loops fit belts up to 2" wide
- Mini model (40BP00) fits 2" 5-shot revolvers and sub-compact autos
- Large model (40BP01) fits 3" revolvers and medium- and large-frame autos

Part Number	Color	Model
40BP00BK	Black	Mini
40BP01BK	Black	Large



### NYLON ALASKA GUIDE HOLSTER

- Constructed of durable 1050 denier ballistic nylon
- Adjustable harness system (one size fits most)
- Can be worn in a vertical, horizontal or angled position
- Revolver model includes a speed loader pouch and cartridge loops and fits large-frame revolvers
- Pistol model (40AG02BK) includes a magazine pouch and fits large-frame handguns (Gov't 1911)
- Quick-release retention strap keeps handgun secure

Part Number	Color	Model	Size
40AG01BK	Black	Revolver	01
40AG02BK	Black	Pistol	02



### NYLON AMBIDEXTROUS FLAT BELT HOLSTER

- Ambidextrous design
- Constructed of 1000 denier CORDURA® nylon outer material
- Fits belts up to 2" wide
- Adjustable, reversible thumb break
- Fits most small- to medium-frame and medium- to large-frame autos and revolvers

Part Number	Color
40FB02BK	Black



### NYLON CONCEALED WEAPON FANNY PACK HOLSTER

- Constructed of 1000 denier CORDURA® nylon outer material
- Retention belt loops attach to belt for extra security and retention
- Universal design fits most small- to medium-frame and medium- to large-frame autos and revolvers

Part Number	Color	Model
60WF04BK	Black	Small
60WF05BK	Black	Medium
60WF06BK	Black	Large



### NYLON ΩMEGA® VI IMPROVED UNIVERSAL AMBIDEXTROUS DROP LEG HOLSTER

- Ambidextrous design
- Constructed of 500 denier CORDURA® nylon
- Designed primarily for law enforcement officers
- Y-harness drop-leg platform for even weight distribution
- Elastic, rubberized leg straps for stability and comfort
- Adjustable thumb break with retention strap for secure fit
- Fits most pistols with or without light or laser aiming module

Part Number	Color	Model
40ALH1BK	Black	Nylon Ωmega VI Improved Drop Leg
40ALH1CT	Coyote Tan	Nylon Ωmega VI Improved Drop Leg
40ALH1AU	ARPAT	Nylon Ωmega VI Improved Drop Leg





## HOLSTER ACCESSORIES

### SINGLE MAG CASES

- Features a built-in tension spring to securely hold magazines of various sizes
- Remove the belt clip and place two Single Mag Cases side-by-side on Dual Rail Accessory Platform
- Single-stack versions fit 9mm/.40 cal/.45 cal/10mm/.357 Sig
- Double-stack versions fit 9mm/.40 cal

#### MATTE FINISH

Part Number	Color	Description
410500PBK	Black	Single Stack
410500PCT	Coyote Tan	Single Stack
410500POD	Olive Drab	Single Stack
410500PFG	Forest Green	Single Stack
410600PBK	Black	Double Stack
410600PCT	Coyote Tan	Double Stack
410600POD	Olive Drab	Double Stack
410600PFG	Forest Green	Double Stack

#### CARBON-FIBER FINISH

Part Number	Color	Description
410500CBK	Black	Single Stack
410600CBK	Black	Double Stack



### DOUBLE MAG CASES

- Built-in tension spring securely holds magazines of various sizes
- Includes belt loops and belt clip
- Curved to waistline for slimmer profile
- Single-stack versions fit 9mm/.40 cal/.45 cal/10mm/.357 Sig
- Double-stack versions fit 9mm/.40 cal/.45 cal/10 mm/.357 Sig

Part Number	Color	Finish	Description
410510CBK	Black	Carbon Fiber	Single Stack
410510PBK	Black	Matte	Single Stack
410610CBK	Black	Carbon Fiber	Double Stack
410610PBK	Black	Matte	Double Stack



### PADDLE PLATFORM WITH SCREWS

- Designed to fit any BLACKHAWK!® injection-molded concealment holster

Part Number	Description	Color
410902BK	Paddle Platform	Black



### BELT LOOP PLATFORM WITH SCREWS

- Designed to fit any BLACKHAWK!® injection-molded concealment holster

Part Number	Description	Color
410901BK	Belt Loop Platform	Black





DUTY HOLSTERS

SERPA® LEVEL 2 AUTO LOCK™ DUTY HOLSTER

- SERPA® Auto Lock™ release
- Passive retention detent adjustment screw
- Full-length holster body protects rear sights
- Includes unique Jacket Slot Duty Belt Loop to attach to belt without unthreading other gear
- Mid-Ride Duty Belt Loop and High-Ride Duty Belt Loop also available (sold separately)
- Fits all BLACKHAWK!® injection-molded platforms



Matte Finish

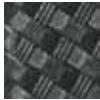

Basketweave Finish

MATTE FINISH

Part Number	Color	Fit
44H000BK-R	Black	Glock 17/19/22/23/31/32
44H000BK-L	Black	Glock 17/19/20/21/22/23/31/32 and S&W M&P 9/.40
44H003BK-R or L	Black	Gov't 1911 and Clones with or without Rails
44H004BK-R or L	Black	Beretta 92/96/M9/M9A1 (Not For Brig./Elite/92A1/96A1)
44H006BK-R or L	Black	Sig 220/225/226/228/229 with or without Rails
44H008BK-R or L	Black	Sig Pro 2022
44H013BK-R	Black	Glock 20/21/21SF/37/38 and S&W M&P (All Models) with or without Rails
44H026BK-R	Black	Glock 21SF with Larger 1913 Rails

BASKETWEAVE FINISH

Part Number	Color	Fit
44H000BW-R	Black	Glock 17/19/22/23/31/32
44H000BW-L	Black	Glock 17/19/20/21/22/23/31/32 and S&W M&P 9/.40
44H003BW-R or L	Black	Gov't 1911 and Clones with or without Rails
44H004BW-R or L	Black	Beretta 92/96/M9/M9A1 (Not For Brig./Elite/92A1/96A1)
44H006BW-R or L	Black	Sig 220/225/226/228/229 with or without Rails
44H008BW-R or L	Black	Sig Pro 2022
44H013BW-R	Black	Glock 20/21/21SF/37/38 and S&W M&P (All Models) with or without Rails
44H026BW-R	Black	Glock 21SF with Larger 1913 Rails





## SERPA® LEVEL 3 AUTO LOCK™ DUTY HOLSTER –MATTE FINISH

- SERPA® Auto Lock™ release
- Passive retention detent adjustment screw
- Thumb-activated Pivot Guard for additional security
- Full-length holster body protects rear sights
- Includes innovative Jacket Slot Duty Belt Loop
- Mid-Ride Duty Belt Loop and High-Ride Duty Belt Loop also available (sold separately)
- Fits all BLACKHAWK!® injection-molded platforms

Part Number	Color	Fit
44H100BK-R or L	Black	Glock 17/19/22/23/31/32
44H103BK-R or L	Black	Gov't 1911 and Clones with or without Rails
44H104BK-R or L	Black	Beretta 92/96/M9/M9A1 (Not For Brig./Elite/92A1/96A1)
44H106BK-R or L	Black	Sig 220/225/226/228/229 with or without Rails
44H107BK-R or L	Black	Springfield XD/XDM
44H108BK-R or L	Black	Sig Pro 2022
44H109BK-R or L	Black	H&K USP Compact/P2000 (Euro)
44H110BK-R or L	Black	S&W 5946
44H113BK-R or L	Black	Glock 20/21/21SF (Not 1913 Rail)/37/38
44H116BK-R or L	Black	H&K P2000 (US)
44H114BK-R or L	Black	H&K Full Size USP 9/.40
44H117BK-R or L	Black	H&K P30
44H124BK-R or L	Black	Walther P99
44H125BK-R or L	Black	S&W M&P 9/.40 with or without Thumb Safety
44H145BK-R or L	Black	S&W M&P .45 and 9/.40 Pro with or without Thumb Safety
44H179BK-R or L	Black	H&K SFP9/VP9



## SERPA® LEVEL 3 AUTO LOCK™ DUTY HOLSTER –BASKETWEAVE FINISH

- SERPA® Auto Lock™ release
- Passive retention detent adjustment screw
- Thumb-activated Pivot Guard for additional security
- Full-length holster body protects rear sights
- Includes innovative Jacket Slot Duty Belt Loop
- Mid-Ride Duty Belt Loop and High-Ride Duty Belt Loop also available (sold separately)
- Fits all BLACKHAWK!® injection-molded platforms

Part Number	Color	Fit
44H100BW-R or L	Black	Glock 17/19/22/23/31/32
44H103BW-R or L	Black	Gov't 1911 and Clones with or without Rails
44H104BW-R or L	Black	Beretta 92/96/M9/M9A1 (Not For Brig./Elite/92A1/96A1)
44H106BW-R or L	Black	Sig 220/225/226/228/229 with or without Rails
44H107BW-R or L	Black	Springfield XD/XDM
44H109BW-R or L	Black	H&K USP Compact/P2000 (Euro)
44H110BW-R or L	Black	S&W 5946
44H113BW-R or L	Black	Glock 20/21/21SF (Not 1913 Rail)/37/38
44H116BW-R or L	Black	H&K P2000 (US)
44H114BW-R or L	Black	H&K USP Full Size 9/.40
44H125BW-R or L	Black	S&W M&P 9/.40 with or without Thumb Safety
44H145BW-R or L	Black	S&W M&P .45 and 9/.40 Pro with or without Thumb Safety



## SERPA® LEVEL 3 LIGHT-BEARING AUTO LOCK™ DUTY HOLSTER

- SERPA® Auto Lock™ release
- Passive retention detent adjustment screw
- Thumb-activated Pivot Guard for additional security
- Full-length holster body protects rear sights
- Includes innovative Jacket Slot Duty Belt Loop
- Mid-Ride Duty Belt Loop and High-Ride Duty Belt Loop also available (sold separately)
- Accommodates Night-Ops® Xiphos™ NTX Weapon Mounted Light
- Fits all BLACKHAWK!® injection-molded platforms



### MATTE FINISH

Part Number	Color	Fit
44H500BK-R or L	Black	Glock 17/19/22/23/31/32
44H503BK-R or L	Black	Gov't 1911 and Clones with or without Rails
44H504BK-R or L	Black	Beretta 92/96/M9/M9A1 (Not For Brig./Elite/92A1/96A1)
44H505BK-R or L	Black	Sig 228/229
44H506BK-R or L	Black	Sig 220/225/226
44H513BK-R or L	Black	Glock 20/21/21SF
44H516BK-R or L	Black	H&K P2000 (US)
44H525BK-R or L	Black	S&W M&P 9/.40 with or without Thumb Safety
44H545BK-R or L	Black	S&W M&P .45 and 9/.40 Pro with or without Thumb Safety

### BASKETWEAVE FINISH

Part Number	Color	Fit
44H500BW-R or L	Black	Glock 17/19/22/23/31/32
44H503BW-R or L	Black	Gov't 1911 and Clones with or without Rails
44H504BW-R or L	Black	Beretta 92/96/M9/M9A1 (Not For Brig./Elite/92A1/96A1)
44H505BW-R or L	Black	Sig 228/229
44H506BW-R or L	Black	Sig 220/225/226
44H513BW-R or L	Black	Glock 20/21/21SF
44H516BW-R or L	Black	H&K P2000 (US)
44H525BW-R or L	Black	S&W M&P 9/.40 with or without Thumb Safety
44H545BW-R or L	Black	S&W M&P .45 & 9/.40 Pro with or without Thumb Safety

## TASER® SIDE MOUNT PLATE

- Mounts the TASER X26 Cartridge Holder to TASER X26 Duty Holster and saves space
- Unique front side positioning allows for fast reloads without taking up too much space
- Ideal for officers with small waists
- Perfect for mounting on a crowded MOLLE vest
- Fits duty belts up to 2.25" wide
- Positions spare cartridge to outboard side of TASER® X26 Duty Holster (sold separately)
- Available in right- or left-hand models

Part Number	Color	Description
44H907BK-R or L	Black	TASER® Side Mount Plate





## EPOCH™ LEVEL 3 LIGHT-BEARING DUTY HOLSTER



- Passive retention detent screw
- EPOCH™ Auto Lock™ thumb release (patent pending)
- Thumb-activated Pivot Guard and Ejection-Port Lock
- Fits popular lights (TLR-1®, TLR-2®, X300U-A/B)
- Reinforces full master grip
- No snaps or hoods to accidentally open
- Includes innovative Jacket Slot Duty Belt Loop
- Mid-Ride Duty Belt Loop and High-Ride Duty Belt Loop also available (sold separately)
- Fits all BLACKHAWK!® injection-molded platforms

### MATTE FINISH

Part Number	Color	Fit
44E000BK-R or L	Black	Glock 17/22/31
44E013BK-R or L	Black	Glock 20/21/37
44E025BK-R or L	Black	S&W M&P 9/357/40
44E045BK-R or L	Black	S&W M&P .45
44E061BK-R or L	Black	Sig P320

### BASKETWEAVE FINISH

Part Number	Color	Fit
44E000BW-R or L	Black	Glock 17/22/31
44E013BW-R or L	Black	Glock 20/21/37
44E025BW-R or L	Black	S&W M&P 9/357/40
44E045BW-R or L	Black	S&W M&P .45
44E061BW-R or L	Black	Sig P320



Matte Finish



Basketweave Finish

## TASER® X26 LEVEL 2 DUTY HOLSTER

- Automatically engages the safety when re-holstering
- Holster bottom is configured to block the probes in case of accidental activation
- Trigger and trigger guard are completely enclosed inside holster
- Carries TASER® X26 with optional camera unit attached
- Extended coverage protects polycarbonate digital readout window
- Belt loop fits most duty belts
- Rigid holster body delivers improved retention
- Protects cartridge in holster
- Designed to hold the TASER® X26 Cartridge Holder (sold separately)



Matte Finish

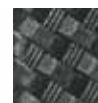

Basketweave Finish

Part Number	Color	Description	Size
44H015BK R or L	Black	Taser® X26 Level 2 Duty Holster Matte	15
44H015BW R or L	Black	Taser® X26 Level 2 Duty Holster Basketweave	15
44H015PL R or L	Black	Taser® X26 Level 2 Duty Holster Plain	15



Matte Finish



## TACTICAL HOLSTERS

## SERPA® LEVEL 2 TACTICAL HOLSTER

- SERPA® Auto Lock™ release
- Passive retention detent adjustment screw
- Full-length holster body protects rear sights
- Flexible thigh platform conforms to leg size
- Y-harness suspension system distributes weight evenly, keeps holster vertical and allows use of pocket
- Quick-disconnect swivel buckles for quick holster mounting/dismounting
- Accessory mounting points for pouches, knives, mag cases, etc.
- Hole in holster body for optional bungee retention
- Rubberized leg straps eliminate sliding
- Fits all BLACKHAWK!® injection-molded platforms



Black



Coyote Tan



Olive Drab



Foliage Green



## MATTE FINISH

Part Number	Color	Fit
430500BK-R	Black	Glock 17/19/22/23/31/32
430500BK-L	Black	Glock 17/19/20/21/22/31/32 and S&W M&P 9/.40/.45
430503BK-R or L	Black	Gov't 1911 and Clones with or without Rails
430503CT-R or L	Coyote Tan	Gov't 1911 and Clones with or without Rails
430503OD-R or L	Olive Drab	Gov't 1911 and Clones with or without Rails
430504BK-R or L	Black	Beretta 92/96/M9/M9A1 (Not For Brig./Elite/92A1/96A1)
430504CT-R or L	Coyote Tan	Beretta 92/96/M9/M9A1 (Not For Brig./Elite/92A1/96A1)
430504CT-R or L-USMC	Coyote Tan	Beretta 92/96/M9/M9A1 with USMC Medallion (Not Elite or Brig.)
430504FG-R or L	Foliage Green	Beretta 92/96/M9/M9A1 (Not For Brig./Elite/92A1/96A1)
430504FG-R or L-Army	Foliage Green	Beretta 92/96/M9/M9A1 US Medallion (Not Elite or Brig.)
430504OD-R or L	Olive Drab	Beretta 92/96/M9/M9A1 (Not For Brig./Elite/92A1/96A1)
430506BK-R or L	Black	Sig 220/225/226/228/229 with or without Rails
430506CT-R or L	Coyote Tan	Sig 220/225/226/228/229 with or without Rails
430506OD-R or L	Olive Drab	Sig 220/225/226/228/229 with or without Rails
430508BK-R or L	Black	Sig Pro 2022
430513BK-R	Black	Glock 20/21/21SF/37/38 and S&W M&P (All Models) with or without Rails
430526BK-R	Black	Glock 21SF with Larger 1913 Rails





## SERPA® LEVEL 3 TACTICAL HOLSTER



- SERPA® Auto Lock™ release
- Passive retention detent adjustment screw
- Thumb-activated Pivot Guard for additional security
- Full-length holster body protects rear sights
- Flexible thigh platform conforms to leg size
- Y-harness suspension system distributes weight evenly, keeps holster vertical and allows use of pocket
- Quick-disconnect swivel buckles for quick holster mounting/dismounting
- Accessory mounting points for pouches, knives, mag cases, etc.
- Rubberized leg straps eliminate sliding
- Fits all BLACKHAWK!® injection-molded platforms



### MATTE FINISH

Part Number	Color	Fit
430600BK-R or L	Black	Glock 17/19/22/23/31/32
430603BK-R or L	Black	Gov't 1911 and Clones with or without Rails
430604BK-R or L	Black	Beretta 92/96/M9/M9A1 (Not For Brig./Elite/92A1/96A1)
430604FG-R or L	Foliage	Beretta 92/96/M9/M9A1 (Not For Brig./Elite/92A1/96A1)
430606BK-R or L	Black	Sig 220/225/226/228/229 with or without Rails
430607BK-R or L	Black	Springfield XD/XDM
430608BK-R or L	Black	Sig Pro 2022
430609BK-R or L	Black	H&K USP Compact/P2000 (Euro)
430610BK-R or L	Black	S&W 5946
430613BK-L	Black	Glock 20/21/21SF (Not 1913 Rail)/37/38
430614BK-R or L	Black	H&K USP Full Size 9/.40
430616BK-R or L	Black	H&K P2000 (US)
430617BK-L	Black	H&K P30
430624BK-R	Black	Walther P99, S&W SW99
430625BK-R or L	Black	S&W M&P 9/.40 with or without Thumb Safety
430645BK-R or L	Black	S&W M&P .45 and 9/.40 Pro with or without Thumb Safety

### SERPA® LEVEL 3 LIGHT-BEARING TACTICAL HOLSTER



- SERPA® Auto Lock™ release
- Passive retention detent adjustment screw
- Thumb-activated Pivot Guard for additional security
- Full-length holster body protects rear sights
- Flexible thigh platform conforms to leg size
- Y-harness suspension system distributes weight evenly, keeps holster vertical and allows use of pocket
- Quick-disconnect swivel buckles for quick holster mounting/dismounting
- Accessory mounting points for pouches, knives, mag cases, etc.
- Rubberized leg straps eliminate sliding
- Accommodates Night-Ops® Xiphos™ NTX Weapon Mounted Light
- Fits all BLACKHAWK!® injection-molded platforms



Part Number	Color	Fit
430700BK-R or L	Black	Glock 17/19/22/23/31/32
430703BK-R or L	Black	Gov't 1911 and Clones with or without Rails
430704BK-R	Black	Beretta 92/96/M9/M9A1 (Not For Brig./Elite/92A1/96A1)
430704FG-R or L	Foliage Green	Beretta 92/96/M9/M9A1 (Not For Brig./Elite/92A1/96A1)
430705BK-L	Black	Sig P228/P229 w/Xiphos (not E2/1913 Rail)
430706BK-R or L	Black	Sig 220/225/226
430713BK-R or L	Black	Glock 20/21/21SF
430716BK-R or L	Black	H&K P2000 (US)
430725BK-R or L	Black	S&W M&P 9/.40 with or without Thumb Safety
430745BK-L	Black	S&W M&P .45 and 9/.40 Pro with or without Thumb Safety

### EPOCH™ LEVEL 3 LIGHT-BEARING TACTICAL HOLSTER

- Passive retention detent screw
- EPOCH™ Auto Lock™ thumb release (patent pending)
- Thumb-activated Pivot Guard and Ejection-Port Lock
- Fits popular lights (TLR-1®, TLR-2® and X300U-A/B)
- Flexible thigh platform conforms to leg size
- Y-harness suspension system distributes weight evenly, keeps holster vertical and allows use of pocket
- Quick-disconnect swivel buckles for quick holster mounting/dismounting
- Accessory mounting points for pouches, knives, mag cases, etc.
- Rubberized leg straps eliminate sliding

#### PLAIN FINISH

Part Number	Color	Fit
44E600BK-R or L	Black	Glock 17/22/31
44E613BK-R or L	Black	Glock 20/21/37
44E625BK-R or L	Black	S&W M&P 9/357/40
44E645BK-R or L	Black	S&W M&P .45





## NYLON ΩMEGA® VI ULTRA

- For wear on a belt or any S.T.R.I.K.E.® or PALS/MOLLE platform
- Ambidextrous design
- Constructed of 1000 denier CORDURA® nylon outer material
- Elastic, rubberized leg straps for stability and comfort
- Includes Speed Clips™ and three side-release buckles for three-point breakaway
- Front-mounted pouch for extra magazine, knife or light
- Adjustable thumb break with extra hook & loop retention
- Fits most pistols with or without light or laser aiming module

Part Number	Color	Model
40MLH1BK	Black	Nylon Omega VI Ultra
40MLH1CT	Coyote Tan	Nylon Omega VI Ultra
40MLH1OD	Olive Drab	Nylon Omega VI Ultra
40MLH1AU	ARPAT	Nylon Omega VI Ultra



## NYLON ΩMEGA® VI ELITE HOLSTER

- Constructed of 1000 denier CORDURA® nylon outer material
- Elastic, rubberized leg straps for stability and comfort
- Three side-release buckles for three-point breakaway
- Front-mounted pouch for extra magazine, knife or light
- Removable retention strap
- Adjustable thumb break with extra hook & loop retention

Part Number	Color	Model	Size
40QD02BK-R or L	Black	Glock 17/19/22/23/27/31/32 and Sig 226/228	02
40QD02OD-R or L	Olive Drab	Glock 17/19/22/23/27/31/32 and Sig 226/228	02
40QD02DE-R or L	Desert Tan	Glock 17/19/22/23/27/31/32 and Sig 226/228	02
40QD22BK-R or L	Black	Colt 1911 45 and Browning Hi-Power	22
40QD32BK-R or L	Black	Glock 20/21 and USP .40/.45	32
40QD42BK-R or L	Black	Beretta 92F (M9) and S&W 5906	42
40QD42DE-R or L	Desert Tan	Beretta 92F (M9) and S&W 5906	42
40QD42AU-R or L	ARPAT	Beretta 92F (M9) and S&W 5906	42



## NYLON SPECIAL OPERATIONS HOLSTER

- Constructed of 1000 denier CORDURA® nylon outer material
- Elastic, rubberized leg straps for stability and comfort
- Adjustable thumb break for quick draw
- Top flap covers pistol for maximum weapon retention
- Flap secured open by hook & loop or closed by side-release buckle
- Front-mounted pouch for extra magazine, knife or light
- Additional mag pouches can be mounted horizontally on belt flap (pouches not included)
- Fits most semi-auto pistols

Part Number	Color	Size
40XP000D	Olive Drab	00
40XP000D-LEFT	Olive Drab	00



### MILITARY SERPA® COMBO KIT

- SERPA Level 2 Tactical Holster
- Dropleg Platform
- Jacketslot Beltloop
- STRIKE Plate
- Quick Disconnect kit

#### PLAIN FINISH

Part Number	Color	Fit
4305USACT-R or L	Coyote Tan	Beretta 92/96/M9/M9A1



## PLATFORMS / ACCESSORIES

### QUICK DISCONNECT SYSTEM KIT

- Allows one holster to be used on multiple platforms and easy 360-degree adjustments
- Kit includes two Female Adapters and one Male Adapter
- Holster releases by lifting the quick-disconnect tabs and turning counterclockwise

Part Number	Description	Color
430950BK	Quick Disconnect System Kit	Black
430950CT	Quick Disconnect System Kit	Coyote Tan
430950FG	Quick Disconnect System Kit	Forest Green
430950OD	Quick Disconnect System Kit	Olive Drab
430951BK	Quick Disconnect Male Adapter	Black
430951CT	Quick Disconnect Male Adapter	Coyote Tan
430951FG	Quick Disconnect Male Adapter	Forest Green
430951OD	Quick Disconnect Male Adapter	Olive Drab
430952BK	Quick Disconnect Female Adapter	Black
430952CT	Quick Disconnect Female Adapter	Coyote Tan
430952FG	Quick Disconnect Female Adapter	Forest Green
430952OD	Quick Disconnect Female Adapter	Olive Drab







## TACTICAL HOLSTER PLATFORM

- Flexible thigh platform conforms to leg size
- Y-harness suspension system distributes weight evenly, keeps holster vertical and allows use of pocket
- Quick-disconnect swivel buckles for quick holster mounting/dismounting
- Rubberized leg straps eliminate sliding
- Accessory mounting points for pouches, knives, mag cases, etc.
- Requires Duty Accessory Mounting Screw Kit (sold separately) for mounting BLACKHAWK!® Duty Gear
- Accommodates BLACKHAWK!® Injection-molded concealment or duty holsters

Part Number	Description	Color
432000PBK	Tactical Holster Platform	Black
432000PCT	Tactical Holster Platform	Coyote Tan
432000PFG	Tactical Holster Platform	Forest Green
432000POD	Tactical Holster Platform	Olive Drab



## VERSA-HARNESS™ HOLSTER/ACCESSORY PLATFORM

- Injection-molded multi-position mounting disk with mounting plate and five-position hole pattern
- Ergonomic aero foam shoulder harness
- Nylon webbing with quick-detach buckles
- Compatible with BLACKHAWK!® nylon holsters, injection-molded holsters and Quick Disconnect System adapters
- One size fits most



Holster not included



Part Number	Description	Color
44CH00BK	Versa-Harness Holster/Accessory Platform	Black

## SHOULDER HARNESS HOLSTER PLATFORM

- Tapered, fully adjustable web harness and an offside dual Picatinny rail platform for accessories
- Mount BLACKHAWK! injection-molded concealment holsters to underarm platform in horizontal position
- Enables one-handed re-holstering (right or left hand)
- Medium (41SH00) fits shirt size Medium to XL and Large (41SH01) fits shirt size XL to 3XL

Part Number	Description	Color	Size
41SH00BK-R or L	Shoulder Harness Holster Platform	Black	Medium
41SH01BK-R or L	Shoulder Harness Holster Platform	Black	Large



Holster not included





### SERPA® HOLSTER BUNGEE RETENTION STRAP

- Features a high-strength shock cord for additional weapon security
- Secure to holster with girth hitch or knot and snap over pistol back strap
- Designed to fit SERPA® Level 2 Tactical
- Can be cut to length

Part Number	Description	Color
40BR00BK	SERPA Holster Bungee Retention Strap	Black

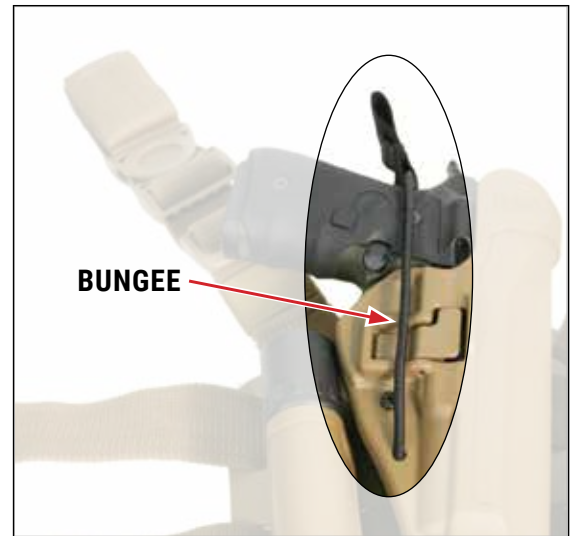

### SERPA® S.T.R.I.K.E.® COMBO KIT (BERETTA ONLY)

- Designed to fit SERPA® CQC® Concealment Holster Beretta M9/92/96 (not Elite, Brigadier or M9A1)
- Includes Tactical Holster Platform
- Includes S.T.R.I.K.E.® Platform with SERPA® Holster
- Includes Belt Loop Platform
- Includes Shoulder Harness Holster Platform (black only)
- Medium (40SC02) fits shirt size Medium to XL
- Large (40SC03) fits shirt size XL to 3XL

Part Number	Description	Color	Size
40SC02CT-R or L	SERPA S.T.R.I.K.E. Combo Kit	Coyote Tan	Medium
40SC02FG-R or L	SERPA S.T.R.I.K.E. Combo Kit	Forest Green	Medium
40SC03CT-R or L	SERPA S.T.R.I.K.E. Combo Kit	Coyote Tan	Large
40SC03FG-R or L	SERPA S.T.R.I.K.E. Combo Kit	Forest Green	Large



## HIGH-RIDE DUTY BELT LOOP WITH SCREWS

- Designed to fit any BLACKHAWK!® injection-molded duty holster
- Moves holster higher on duty belt
- Fits 2" and 2.25" duty belts

Part Number	Description	Color
44H900BK	High-Ride Duty Belt Loop	Black



## JACKET SLOT DUTY BELT LOOP WITH SCREWS

- Designed to fit any BLACKHAWK!® injection-molded duty holster
- Attach holster to duty belt without unthreading other gear
- Fits 2" and 2.25" duty belts

Part Number	Description	Color
44H901BK	Jacket Slot Duty Belt Loop	Black



## MID-RIDE DUTY BELT LOOP WITH SCREWS

- Designed to fit any BLACKHAWK!® injection-molded duty holster
- Moves holster higher on duty belt
- Fits 2" and 2.25" duty belts

Part Number	Description	Color
44H902BK	Mid-Ride Duty Belt Loop	Black



## MOD-U-LOK™ PLATFORM WITH SCREWS

- Designed to fit any BLACKHAWK!® injection-molded concealment holster
- Quick disconnect belt loop
- Attach holster to duty belt without unthreading other gear
- One-handed release from belt
- Positive engagement keeps belt loop in place
- Includes spacer for use with narrower belts
- Fits belts up to 2.25" wide

Part Number	Description	Color
410904BK	Mod-U-Lok Platform	Black



### TACTICAL PISTOL LANYARD COILED

- Made with coiled wire and black rubber external laminate
- Attaches to belt with loop
- 90TPL1BK attaches to firearm with gutted 550 Cord (not included)
- 90TPL1BK attaches to firearm with snap hook and mini ring
- Allows full extension while shooting

Part Number	Description	Color
90TPL1BK	Coiled (Non Swivel)	Black
90TPL2BK	Coiled (Single Swivel/Snap Hook/Mini Ring)	Black



### QUICKMOD™ MAGAZINE CASES

- Rotating and locking quick-detach belt attachment
- Adjustable to belts 1.5 to 2.25 inches wide
- Positive lock indicator for added security
- Can be rotated 360 degrees with 16 arrest positions

Part Number	Description	Color
411600BK	QuickMod Pistol Magazine Case	Black
411601BK	QuickMod AR-15 Magazine Case	Black





## S.T.R.I.K.E.® PLATFORM

- Ambidextrous adapter platform
- Constructed of injection-molded polymer carbon-fiber blend
- Designed to fit any BLACKHAWK!® injection-molded holster at any angle
- Holds rail-mounted accessories such as mag cases, light cases, knife sheaths, etc.
- Can be mounted to any S.T.R.I.K.E.® or PALS/MOLLE platform
- Does not include holster

Part Number	Description	Color
38CL63BK	S.T.R.I.K.E Platform	Black
38CL63CT	S.T.R.I.K.E Platform	Coyote Tan
38CL63FG	S.T.R.I.K.E Platform	Forest Green
38CL63OD	S.T.R.I.K.E Platform	Olive Drab



## S.T.R.I.K.E.® PLATFORM WITH SERPA® HOLSTER (BERETTA ONLY)

- Ambidextrous adapter platform
- Designed to fit SERPA® CQC® Concealment Holster at any angle
- For Beretta M9/92/96 (not Elite, Brigadier or M9A1)
- Can be mounted to any S.T.R.I.K.E.® or PALS/MOLLE platform
- Holster included

Part Number	Description	Color
40CL01FG-R	S.T.R.I.K.E. Platform with SERPA Holster	Forest Green
40CL01FG-L	S.T.R.I.K.E. Platform with SERPA Holster	Forest Green
40CL01CT-R or L	S.T.R.I.K.E. Platform with SERPA Holster	Coyote Tan



## HOLSTER SPACER KIT

- Adjust the angle or distance away from the body of any BLACKHAWK!® injection-molded holster
- Concealment Holster Spacer Kit (411400C) includes two spacers and 8-32 screws
- Tactical/Duty Holster Spacer Kit (411401C) includes one spacer and 10-32 screws

Part Number	Description	Color
411400CBK	Concealment Holster Spacer Kit	Black
411401CBK	Tactical/Duty Holster Spacer Kit	Black



### TASER X26/X26P CARTRIDGE HOLDER

- Attaches easily to BLACKHAWK!® TASER® X26 Duty Holster
- Rapid reload capability
- Mini Mod-U-Lok™ belt loop with adjustable spacer fits most duty belts
- Ambidextrous design

Part Number	Color	Description
44A890BK	Black	TASER® X26 Cartridge Holder



### DUAL RAIL™ ACCESSORY PLATFORM

- High-strength proprietary Polymer construction
- Designed for weapon-mounted Picatinny rail lights such as Streamlight® TLR-1®/ TLR-2® family of lights
- Removable M-3 holder
- Available in paddle or belt loop models

Part Number	Color	Description
410800CBK	Black	Dual Rail™ Accessory Platform Paddle Mount
411300CBK	Black	Dual Rail™ Accessory Platform Belt Loop



### COMPACT LIGHT CARRIER

- Designed to hold small, personal-sized lights such as Streamlight® Scorpion®, TL-2® or TL-3®
- Button recess at bottom prevents accidental light activation
- Built-in tension device provides secure light carry
- Removable belt clip
- Can be mounted to BLACKHAWK!® Dual Rail™ Accessory Platform (sold separately)

Part Number	Color	Finish	Description
411000CBK	Black	Carbon Fiber	Compact Light Carrier
411000PBK	Black	Matte	Compact Light Carrier
411000PCT	Coyote Tan	Matte	Compact Light Carrier
411000POD	Olive Drab	Matte	Compact Light Carrier
411000PFG	Forest Green	Matte	Compact Light Carrier







## TACTICAL MAG POUCH

- High-strength proprietary polymer construction
- Molded flap with snap retains magazine
- Mounts directly to Tactical Holster platforms (sold separately)

Part Number	Color	Description
430900BK	Black	Tactical Mag Pouch
430900CT	Coyote Tan	Tactical Mag Pouch
430900OD	Olive Drab	Tactical Mag Pouch
430900FG	Forest Green	Tactical Mag Pouch



## DEMONSTRATOR REPLICAS GUNS

- Exact size of real pistol
- Injection-molded high-strength, glass-filled polymer
- Available in Safety Orange (OR)

Part Number	Color	Description
44DGGL17OR	Orange	Glock 17/22/31
44DGB92FOR	Orange	Beretta 92/96
44DG226ROR	Orange	Sig 226 with Rail
44DG1911OR	Orange	Colt 1911 with Rail
44DSGWJFOR	Orange	S&W J-Frame

**NEW! MULTIPOINT SLING**

Superior comfort comes via the nylon construction that features a slick-edged, wide webbing that disperses the weight of the firearm – ideal for hours of continuous wear. A patented rapid adjust slider quickly changes sling length, even on the move. Designed to operate in the most demanding environments, the rugged, lightweight MultiPoint Sling is the perfect blend of comfort, adaptability and speed.



Quick Disconnect



Snap Hook



Free End



Quick Disconnect Slick



Snap Hook Stretch



Quick Disconnect Stretch



Free End Slick

- Nylon weave construction designed for long hours of wear
- Quickly converts to multiple configurations with only one hand
- Rapid Adjustment Slider Buckle enables high-speed rifle transitions
- All-steel quick detach mounting points built to last

Part Number	Description	Color
70SMH03BK	Multi-Point Sling - Snap Hook Slick	Black
70SMH03CT	Multi-Point Sling - Snap Hook Slick	Coyote Tan
70MKE04BK	Multi-Point Sling - Free End Slick	Black
70MKE04CT	Multi-Point Sling - Free End Slick	Coyote Tan
70MCFE05BK	Multi-Point Sling - Cushion Stretch Slick	Black
70MCFE05CT	Multi-Point Sling - Cushion Stretch Slick	Coyote Tan
70MQD01BK	Multi-Point Sling - QD Slick	Black
70MQD01CT	Multi-Point Sling - QD Slick	Coyote Tan
70MQDS02BK	Multi-Point Sling - QD Stretch	Black



## STORM™ SLING XT

- Single-point sling adjusts from 46" to 64" in diameter to fit all body sizes and around bulky vests or gear
- Elliptical bungee provides comfort and support
- Compressed tubular nylon sheathing limits bounce and enhances retention
- Constructed of high-quality 1.25" wide nylon webbing
- Removable, elastic-encased MASH clip for quick, positive firearm attachment
- Heavy-duty tri-glide buckle, metal ring and side-release buckle for quick firearm attachment
- 4" flex for weapon agility and CQB tactics
- Robust bar tacking and box stitching for maximum strength

Part Number	Description	Color
70GS16BK	STORM Sling XT	Black
70GS16CT	STORM Sling XT	Coyote Tan
70GS16MC	STORM Sling XT	MultiCam®



## TACTICAL RELEASABLE S.T.R.I.K.E.® SLING

- Heavy-duty elliptical bungee and tubular nylon webbing design is fully adjustable
- Metal snap hook at each end for attachment to most weapon systems, brackets, buckles or webbing
- Adjustable design to fit all operators
- Side-release buckle for quick firearm attachment and removal
- Secure three-point cop-lock buckle in the middle for easy weapon removal from attaching point on vest

Part Number	Description	Color
70GS13BK	Tactical Releasable S.T.R.I.K.E. Sling	Black



## UNIVERSAL TACTICAL 1.25" SLING

- Fully-adjustable and ambidextrous two-point design

Part Number	Description	Color
70UT00BK	Universal Tactical 1.25" Sling	Black



### SHOTGUN SHELL SLING

- Adjustable two-point design constructed of high-quality 2" wide nylon webbing
- Elastic strap holds 15 extra shells
- Attaches to standard sling swivels with durable steel spring hooks



Part Number	Description	Color
43SS15BK	Shotgun Shell Sling	Black

### SWIFT MACHINE GUN SLING (S.A.W./M-240/M-60)

- Fully ambidextrous three-point sling designed specifically for squad automatic weapons
- Robust metal snap hooks attach to sling swivels or ring mounts
- Detachable sling pad made with .375" closed-cell foam to comfortably carry heavy weapons
- In-line quick-release design for quick transition from patrol carry to right or left shoulder firing position



Part Number	Description	Color
70GS09BK	Swift Machine Gun Sling	Black

### MOUNTAIN SLING

- Constructed of high-quality 1.25" wide nylon webbing
- Non-slip backing keeps sling in place
- Two all-steel, blued LOK-DOWN™ swivels for easy attachment
- One-hand operation



Part Number	Description	Color
73SM00BK	Mountain Sling	Black

### SPORTSTER™ SINGLE-POINT SLING WITH NYLON MOUNT

- Constructed of durable 1.25" nylon webbing
- Robust bar tacking and box stitching for maximum strength
- Simple single-point sling design for use with rifles and shotguns
- Ambidextrous design for easy left- or right-hand use
- Strong snap hook for quick, positive firearm attachment
- Adjustable length to fit a variety of body sizes
- Integrated side-release buckle for quick sling removal
- Includes universal mount



Part Number	Description	Color
74GS19BK	Sportster Single-Point Sling with Nylon Mount	Black





## STORM™ SLING QD

- Single-point sling adjusts from 30" to 50"
- Removable, elastic-encased MASH Clip for quick, positive firearm attachment
- Robust bar tacking and box stitching for maximum strength.
- Constructed of high-quality 1.25" wide nylon webbing
- Heavy-duty tri-glide buckle, metal ring and side-release buckle for quick firearm attachment

Part Number	Description	Color
70GS15BK	STORM Sling QD	Black



## STORM™ SLING

- Single-point sling is constructed of high-strength 1.25" wide nylon webbing with an elliptical bungee
- Compressed tubular nylon sheathing limits bounce and enhances retention
- Elastic-encased MASH Clip for quick, positive firearm attachment
- Heavy-duty tri-glide buckle, metal ring and single side-release buckle for quick attachment
- 4" flex for weapon agility and CQB tactics
- Adjusts from 46" to 64" in diameter to fit all body sizes and around bulky tactical vests or gear

Part Number	Description	Color
70GS12BK	STORM Sling	Black



## STORM™ SLING XT/QD AND SUB-GUN SLING QUICK DISCONNECT ATTACHMENT

- Extra attachment assembly for multiple firearms

Part Number	Description	Color
70SA02BK	Sling Quick Disconnect Attachment	Black



## QD SWIVEL SLING ADAPTER

- Heavy-duty QD swivel
- Compatible with STORM™ Sling RS, QD, XT and Sub-Gun Sling

Part Number	Description	Color
70SA03BK	QD Swivel Sling Adapter	Black



## WEAPONS CATCHES/SHELL HOLDERS

### CQD® MARK III™ STEALTH WEAPONS CATCH

- Ultra-quiet with no hook & loop or snaps
- Robust spring-steel catch guarantees years of reliable performance
- Ambidextrous design
- Adjustable, removable elastic weapon retention strap
- Secures shotguns, rifles, less-than-lethal weapons and manual entry tools
- Includes two Speed Clips™ for S.T.R.I.K.E.® webbing attachment and two metal ALICE Clips for belt mounting

Part Number	Description	Color
71WC00BK	CQD Mark III Stealth Weapons Catch	Black
71WC00CT	CQD Mark III Stealth Weapons Catch	Coyote Tan



### SHOTGUN BANDOLEER

- Constructed of high-quality 2.25" military belt nylon webbing and heavy-duty 1.5" elastic
- Holds 55 shotgun shells securely

Part Number	Description	Color
43SB55BK	Shotgun Bandoleer	Black



### ON-GUN POUCHES AND PADS

#### BUTTSTOCK SHOTGUN SHELL POUCH

- Fully ambidextrous design
- Constructed of lightweight nylon ripstop (pouch and lid)
- Shells are secured by elastic and protected by pouch and cover flap with hook & loop closure
- Holds five 2.25" or 3" shells
- Dual holding points for security

Part Number	Description	Color
52BS02BK	Buttstock Shotgun Shell Pouch	Black



#### M4 COLLAPSIBLE STOCK MAG POUCH

- Constructed of lightweight nylon ripstop
- Fits most collapsible stock designs
- Adjustable lid for 20- or 30-round magazines

Part Number	Description	Color
52BS17BK	M4 Collapsible Stock Mag Pouch	Black



#### TACTICAL CHEEK PAD

- Non-slip material for positive cheek weld
- Height-adjustable inserts
- Adjustable straps with end retaining strap to prevent forward slip

Part Number	Description	Color
90CP01BK	Tactical Cheek Pad	Black





## RIFLE CHEEK PAD

- Constructed of 1000 denier nylon and closed-cell foam
- Aids eye relief efficiency, prevents slipping and reduces recoil to neck and cheek
- Adjustable tie-down system fits most rifle stocks
- Patent D490494

Part Number	Description	Color
90CP00BK	Rifle Cheek Pad	Black



## AMMO CHEEK PAD

- Constructed of 1000 denier nylon
- Non-slip material for positive cheek weld
- Allows for quick reload and instant visual of ammo status
- Zippered utility pouch and external ammunition storage

Part Number	Description	Color
90CP02BK	Ammo Cheek Pad	Black

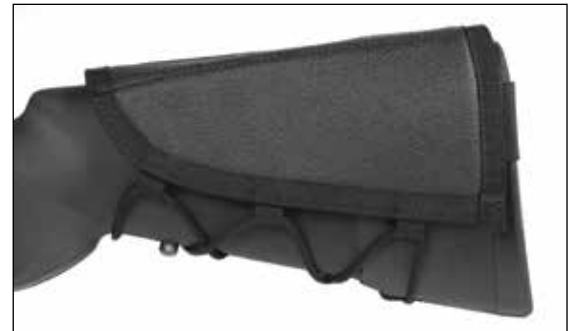

## URBAN WARFARE IVS™ PERFORMANCE VENTILATING CHEEK PAD

- IVS™ compression-molded technology for enhanced performance
- Optimizes cheek weld, eye relief and ventilation for extended use
- Raises comb height for improved alignment with large tactical scopes
- Zippered utility pouch and external ammunition storage

Part Number	Description	Color
90CP05BK	Urban Warfare IVS™ Performance Ventilating Cheek Pad	Black



## BUTTSTOCK SHELL HOLDER (OPEN)

- Open style elastic sleeve slips over rifle or shotgun stock for quick ammo access
- Sewn-on elastic loops keep ammo in place
- Rifle model includes nine ammo loops
- Shotgun model includes five ammo loops

Part Number	Description	Color
74SH00BK	Rifle Buttstock Shell Holder	Black
74SH02BK	Shotgun Buttstock Shell Holder	Black



**NEW! HYBRID FOLDING SIGHT**

The dual aperture swings 180°, with an embedded rare earth magnet securing the sight flat to the sight tower. This patented innovation reduces snags and transitions instantly for close-quarters and mid-range targets. Windage and elevation dials adjust without tools, ensuring optimal accuracy. Durable and lightweight, the Hybrid Folding Sight is built to perform where other sights fail.



- Hybrid construction features solid metal alloy core with advanced co-polymer jacket that eliminates excess bulk.
- Flips up with a gloved hand, holds tight under .308 recoil.
- Tool-less windage and elevation adjustment dials, and steel A2 front sight post aid accurate round placement.
- Rear sight aligns to the M4/AR15 A-frame front sight height.

Part Number	Description	Color
71BU03XX	Hybrid Folding Sights - Front	Black (BK) or Dark Earth (DK)
71BU04XX	Hybrid Folding Sights - Rear	Black (BK) or Dark Earth (DK)
71BU05XX	Hybrid Folding Sights - Pair	Black (BK) or Dark Earth (DK)

To determine the Part #: The 1st 6 digits are the style # (71BU03) followed by the 2-digit color code (BK) . Example: 71BU03BK.  
 Color codes: Black = BK; Flat Dark Earth = DK.





## RAIL MOUNT THUMB REST

- Provides a reference point on forend for consistent grip
- Improves weapon manipulation and control
- Enhances function of other accessories such as vertical grips
- Can be inverted to provide both high and low grip options
- Symmetrical design for ambidextrous use
- Constructed of high-performance glass-reinforced polymer
- Fits Picatinny style rails
- Weighs only 1.3oz



Part Number	Description	Color
71RM00BK	Rail Mount Thumb Rest	Black
71RM00GY	Rail Mount Thumb Rest	Gray

## AR-15 OFFSET SAFETY SELECTOR

- Drop-in replacement safety selector for AR platform firearms
- Improves ergonomics and facilitates easier manipulation
- Little to no change in strong hand grip required when returning weapon to safe
- High-quality materials and finish



Part Number	Description	Color
71SS03BK	RH Offset Safety Selector	Black
71SS04BK	Ambidextrous Offset Safety Selector	Black



71SS03

71SS04

## AR-15 OVERSIZED TRIGGER GUARD

- Drop-in replacement enlarged to allow better access to the trigger
- Constructed of 6061-T6 aluminum with matte Type-III hard-coat anodized finish
- Designed to accommodate shooters wearing gloves



Part Number	Description	Color
71TG01BK	AR-15 Oversized Trigger Guard	Black

### SWIVEL STUD PICATINNY RAIL ADAPTER

- Constructed of rugged 6061 T6 aluminum with Type-III hard-coat anodized finish
- Provides Picatinny rail section for rail-mounted accessories
- Contains side swivel stud for continued use of sling
- Mounts to existing rifle swivel stud
- Weighs 1.7oz

Part Number	Description	Color
71RA00BK	Swivel Stud Picatinny Rail Adapter	Black



### OFFSET FLASHLIGHT RAIL MOUNT

- Constructed of 6061 T6 aluminum with Type-III hard-coat anodized finish
- For mounting flashlights to Picatinny spec rails
- Offset design for optimal positioning
- Compatible with 1" body flashlights
- Weighs 1.5oz

Part Number	Description	Color
71RM01BK	Offset Flashlight Rail Mount	Black



### AR-15 QUAD RAIL FOREND (TWO PIECE)

- Replaces handguards with no modifications to the weapon
- Slim profile for comfortable handguard-like feel
- Unique vent hole design helps dissipate heat and reduce weight
- Limited rotation push-button sling swivel attachment points on left and right sides
- Interlocking halves for strength and stability
- Carbine length weighs 9.6oz
- Rifle length weighs 15.5oz

Part Number	Description	Color
71QF00BK	Quad Rail Forend Rifle Length	Black
71QF01BK	Quad Rail Forend Carbine Length	Black



### LOW PROFILE RAIL COVER

- Constructed of lightweight Santoprene® with a rubbery grip surface
- Fits most Picatinny spec rails
- 18 slots of length can be cut to size for a custom fit
- Low-profile ladder-style cover for rail protection
- Clip onto rails without removing other attachments

Part Number	Description	Color
71RL00BK	Low Profile Rail Cover	Black
71RL00GY	Low Profile Rail Cover	Gray

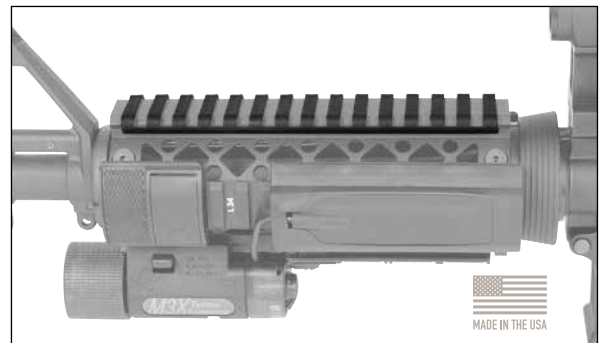



## RAIL MOUNT VERTICAL GRIP

- Molded of high-performance, fiberglass-reinforced polymer
- Redundant clamp screws for secure, reliable mounting and an adjustable fit for out-of-spec rails
- Two different caps (included) for custom length
- O-ring sealed compartment for tools, batteries, etc.
- 3" length and 3.0oz weight for short grip, 4.5" length and 4.1oz weight for long grip

Part Number	Description	Color
71VG00BK	Rail Mount Vertical Grip	Black
71VG00GY	Rail Mount Vertical Grip	Gray

CT - Military/LE Only  
NY - Not for Sale

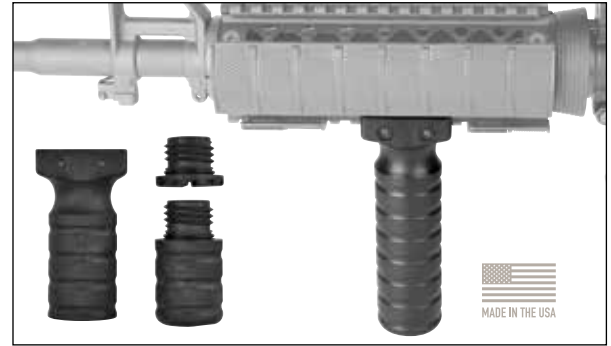

## UNIVERSAL SINGLE-POINT SLING ADAPTER

- Ambidextrous design
- Firearm hangs flat against body
- Compatible with most conventional sling hooks
- Fits AR/M4/M16 collapsible stocks (not compatible with some Colt rifles)

Part Number	Description	Color
70SM04BK	Universal Single-Point Sling Adapter	Black



## AR-15/M4 STORM SLING™ ADAPTER

- For use with AR-15/M4 rifles equipped with collapsible stocks
- Provides ambidextrous mounting points for STORM Slings™
- Simple add-on installation with no modification required
- Fits MIL-spec or commercial tubes

Part Number	Description	Color
71SA05BK	AR-15/M4 STORM Sling Adapter	Black



## RAIL MOUNT SLING ADAPTER

- Constructed of 6061 T6 aluminum with matte Type-III hard-coat anodized finish
- Mounting screw threads into steel insert for additional strength
- Works with snap hooks, MASH clip, wire loops, push-button swivels or sling webbing (up to 1.25" wide)
- Limited rotation push button swivel socket prevents twisted slings



Part Number	Description	Color
71SA00BK	Rail Mount Sling Adapter	Black

### SHOTGUN SINGLE-POINT SLING ADAPTER

- Robust steel construction with durable manganese phosphate finish
- Mounts between receiver and stock
- Provides ambidextrous mounting points
- Compatible with MASH clip, snap hooks and wire loops
- Compatible with STORM Slings or other single-point shotgun slings



Part Number	Description	Color
71SA03BK	Rem 870/1187	Black
71SA04BK	Mossberg 500/590/88	Black

### METAL 1" HEAVY-DUTY SNAP HOOKS

- Robust construction
- Set of two



Part Number	Description	Color
98HM00BK	Metal 1" Heavy-Duty Snap Hooks	Black

### HEAVY DUTY PUSH BUTTON SLING SWIVEL

- Constructed of quality materials with durable manganese phosphate finish
- Allows operator to quickly attach/detach sling from the weapon
- Compatible with most push-button swivel mounting points



Part Number	Description	Color
71SS00BK	Heavy Duty Push Button Sling Swivel	Black

## SPECIALTY SWIVELS

### PUSH BUTTON DETACHABLE

- Flush-mount front and rear bases for stud-free profile with sling and swivels removed
- Bases glue in place (no screws required)

Part Number	Description	Color
70SW16BK	Push Button Swivel Set 1"	Blued





## STANDARD SWIVELS

### ACTION MACHINE SCREW TYPE

- Includes LOK-DOWN™ Swivel Set
- Machine screw forend base
- Wood screw rear base

Part Number	Description	Color
70SW01BK	Action Machine Screw Swivel 1"	Black



### BOLT ACTION WOOD SCREW TYPE

- Includes LOK-DOWN™ Swivel Set
- Wood screw forend base and rear base

Part Number	Description	Color
70SW04BK	Bolt Action Wood Screw Swivel 1"	Black



### LOK-DOWN™ SWIVEL SET

- Includes two detachable swivels
- Positive locking mechanism

Part Number	Description	Color
70SW07BK	LOK-DOWN Swivel Set 1"	Black
70SW08BK	LOK-DOWN Swivel Set 1.25"	Black





AR PLATFORMS

**NEW! KNOXX® AR HANDGUARD SET**

- COMFORTABLE- Slim, ergonomic profile offers superior comfort and control
- VERSATILE- QD sling mount and ambidextrous mounting points fit a variety of sling choices
- SAFE- Integrated aluminum shield deflects heat away from shooter’s hand
- DURABLE- Lightweight polymer construction is textured to promote positive grip, withstands bumps and bruises



Carbine



Mid-Length

Part Number	Description	Color
KARHG1BK	Knox AR Handguard Set - Carbine Length	Black
KARHG1DK	Knox AR Handguard Set - Carbine Length	Dark Earth
KARHG2BK	Knox AR Handguard Set - Mid-Length	Black
KARHG2DK	Knox AR Handguard Set - Mid-Length	Dark Earth

**KNOXX® AR PISTOL GRIP**

- BETTER ERGONOMICS- Improved grip angle and palm swell offer a natural, intuitive feel
- TACTILE- Textured gripping surface for maximum stability in any environment
- COLOR OPTIONS- Black, gray, dark earth and olive drab colors allow customization for all AR set ups

Part Number	Description	Color
KARPG1BK	Knox AR Pistol Grip	Black
KARPG1GY	Knox AR Pistol Grip	Gray
KARPG1DK	Knox AR Pistol Grip	Dark Earth
KARPG1OD	Knox AR Pistol Grip	Olive Drab





## AR-15 NO-LATCH CHARGING HANDLE

- LATCH-LESS DESIGN- Improves reliability, ambidextrous manipulation and shooting performance
- MOLDED OVERSIZED HANDLE- Offers smooth, operation, even while wearing gloves
- LIGHT, STRONG- Machined 7075-Aluminum frame and over-molded polymer handle for optimal strength-to-weight ratio

Name	Part Number	Description
AR-15 NO-LATCH CHARGING HANDLE	71CH00BK	Black
AR-15 NO-LATCH CHARGING HANDLE	71CH00GY	New Gray
AR-15 NO-LATCH CHARGING HANDLE	71CH00DK	Dark Earth
AR-15 NO-LATCH CHARGING HANDLE	71CH00OD	Olive Drab

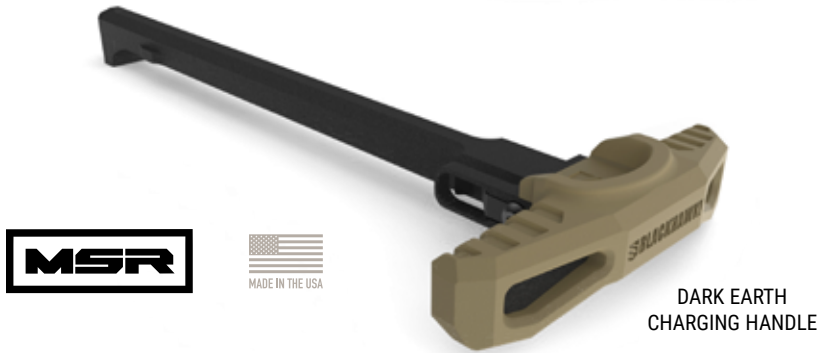
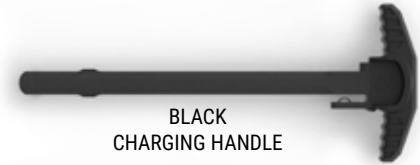

## KNOXX® AXION A-FRAME™ CARBINE STOCK

- PROPRIETARY BUTT PAD- Offers smooth shooting experience
- PORTABLE- Multiple integrated QD Sling Mount for quick, easy sling attachment
- CUSTOMIZABLE- Forward LOP adjustment cam and integrated fit, adjustment screw for custom setup



Part Number	Description	Color
KAR011BK	Knox A-Frame Carbine Stock	Milspec Tube - Black
KAR011GY	Knox A-Frame Carbine Stock	Milspec Tube - Gray
KAR011DK	Knox A-Frame Carbine Stock	Milspec Tube - Dark Earth
KAR011OD	Knox A-Frame Carbine Stock	Milspec Tube - Olive Drab
KAR001BK	Knox A-Frame Carbine Stock	Commercial Tube - Black
KAR001GY	Knox A-Frame Carbine Stock	Commercial Tube - Gray
KAR001DK	Knox A-Frame Carbine Stock	Commercial Tube - Dark Earth
KAR001OD	Knox A-Frame Carbine Stock	Commercial Tube - Olive Drab

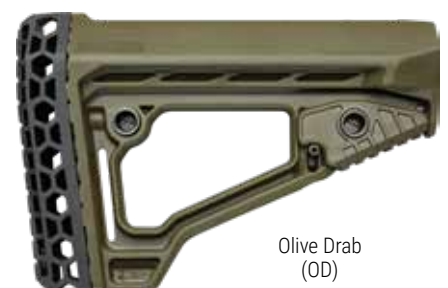

SHOTGUN

**KNOXX® BREACHERSGRIP™ GEN III**

- RECOIL REDUCTION- Patent-pending design mitigates recoil on heavy shotgun loads.
- ERGONOMIC- Comfort and control in any environment.
- INTEGRATED SLING MOUNT- Push-button sling mount

Part Number	Description	Color
K38702-C	Knox® Breachers Grip™ Gen III Remington 870	Black
K35002-C	Knox® Breachers Grip™ Gen III Mossberg 500	Black



**KNOXX® SPECOPS STOCK GEN III™**

- Reduces felt recoil by up to 80 percent
- Adjusts to six different positions to adapt to any shooter
- Buttstock tensioner removes rattle
- Multiple ambidextrous sling mounting locations
- Easy installation

Part Number	Description	Color
K38701-C	Rem 870	Black
K35001-C	Mossberg® 500	Black





## KNOXX® PERFORMANCE SHOTGUN STOCK

- Ambidextrous design with lightweight polymer and alloy construction
- No recoil-compensation systems
- Ergonomic design with integrated grip texture
- Comfortable 13.75" length-of-pull
- Short Tactical Length model (K09120-C) has 12.5" length-of-pull

Part Number	Description	Color
K09100-C	Rem 870 12 Gauge (All Varieties)	Black
K09150-C	Rem 870 12 Gauge (All Varieties)	Less Lethal Orange



## KNOXX® POWERPAK SYSTEM™

- Ambidextrous design
- High cheek piece for use with raised optics
- Low cheek piece for use with low-rise sights
- Shell holder carries five 12-gauge shells for quick reloads
- Watertight storage compartment for spare CR123A batteries or similar-sized items
- Designed specifically for use with all versions of the SpecOps Stock™, SpecOps Stock Gen II™, and SpecOps NRS™ Gen II

Part Number	Description	Color
K04009-C	Knox PowerPak System	Black



## RIFLE

### KNOXX® AXIOM™ ULTRA-LIGHT RIFLE STOCK

- Fiberglass-reinforced polymer and alloy construction with aluminum pillars weighs only 2 lbs., 9 oz.
- Dual recoil-compensation systems reduce harsh recoil
- Rapid-adjust, five-position stock to fit all shooters (11.25" to 15.25" length-of-pull)
- Patented Recoil Reducing Technology

Part Number	Description	Color
K97000-C	Rem 700 BDL SA	Black
K97001-C	Rem 700 BDL LA	Black
K97500-C	Weatherby® Vanguard/Howa 1500 SA	Black
K97501-C	Weatherby® Vanguard/Howa 1500 LA	Black



CT - Military/LE Only  
NY - Not for Sale

## KNOXX® AXIOM™ R/F RUGER® 10/22® RIFLE STOCK

- Designed specifically for Ruger 10/22 rifles
- Includes all standard Knox® rifle stock features
- No recoil-compensation systems
- Rapid-adjust, six-position stock to fit all shooters (9.75" to 13.5" length-of-pull)
- Compatible with bipods



CT - Military/LE Only  
NY - Not for Sale

Part Number	Description	Color
K98200-C	Knox Axiom R/F Ruger 10/22 Stock	Black
K98202-C	Knox Axiom R/F Ruger 10/22 Stock	Coyote Tan

## SUPPRESSORS

### SOUND SUPPRESSORS

- QUIET - Provides superior noise reduction.
- STRONG - Lightweight construction offers an outstanding strength-to-weight ratio.
- GUARANTEED - Limited Lifetime Warrantyj183

Part Number	Name	Description
72SSRF01BK	Pulse	.22LR (full-auto), .17HMR, .22 MAG, .22 WMR, .22Hornet
72SSCP01BK	Smoke Stack	up to .45 cal pistol, sub-sonic .300 BO
72SSCP02BK	Mini Boss	up to 9mm pistol, sub-sonic and super-sonic .300 BO
72SSCR01BK	Barrage	5.56mm MSR
72SSCR02BK	Gas Can	5.56, 7.62 and centerfire rifle up to 300WM
72SSCR03BK	Carnivore	centerfire rifle up to .300 WM!
72SSCR04BK	Wrath	centerfire rifle up to .338 LM



BARRAGE™ 5.56mm      WRATH™ .338 LM      SMOKE STACK™ 45      CARNIVORE™ .300 WM  
 GAS CAN™ 7.62mm      PULSE™ 22LR      MINI BOSS™ 9mm





## SUPPRESSOR ACCESSORIES

Part Number	Name	Description
ADAPTER	72SATA01	.5x28Sig Mosquito Adapter
ADAPTER	72SATA02	.5x28 Wather P22 Adapter
ADAPTER	72SATA03	.5x28 GSG 1911 22LR Adapter
COMPACT ADAPTER	72SATA05	.5x28 S&W M&P 22 Compact Adapter
ADAPTER	72SATA06	.5x20 to .5x28 Adapter
THREAD SPACER	72SATA07	1/4" Thread Spacer .5x28
PISTOL SUPPRESSOR PISTON	72SAPS01	.578x28 Pistol Suppressor Piston
PISTOL SUPPRESSOR PISTON	72SAPS02	.5x28 Pistol Suppressor Piston
PISTOL SUPPRESSOR PISTON	72SAPS03	13.5Mx1LH XL Pistol Suppressor Piston
PISTOL SUPPRESSOR PISTON	72SAPS04	13.5Mx1LH Pistol Suppressor Piston
PISTOL SUPPRESSOR PISTON	72SAPS05	14.5Mx1LH Pistol Suppressor Piston
PISTOL SUPPRESSOR PISTON	72SAPS06	16Mx1LH Pistol Suppressor Piston
PISTOL SUPPRESSOR PISTON	72SAPS07	9/16x24 Pistol Suppressor Piston
PISTOL SUPPRESSOR PISTON	72SAPS08	.5x28 XL Pistol Suppressor Piston
PISTOL SUPPRESSOR FIXED MOUNT	72SAFM01	.5x28 Pistol Suppressor Fixed Mount
PISTOL SUPPRESSOR FIXED MOUNT	72SAFM02	.5x36 Pistol Suppressor Fixed Mount
PISTOL SUPPRESSOR FIXED MOUNT	72SAFM03	5/8x24 Pistol Suppressor Fixed Mount 5/8x24
PISTOL SUPPRESSOR ADAPTER	72SA3L01	Pistol Suppressor 3-Lug Adapter
PISTOL SUPPRESSOR ADAPTER	72SATA08	Pistol Suppressor CZ Scorpion Adapter
PISTOL SUPPRESSOR ADAPTER	72SAFM09	13.5Mx1LH Pistol Suppressor Adapter
FLASH SUPPRESSOR	72FS2201BK	5.56mm Flash Suppressor 1/2x28
MUZZLE BRAKE	72MB2201BK	5.56MM Muzzle Brake 1/2x28
FLASH SUPPRESSOR	72FS3001BK	7.62mm Flash Suppressor 5/8x24
MUZZLE BRAKE	72MB3001BK	7.62mm Muzzle Brake 5/8x24
DIRECT THREAD MOUNT	72SATM01	Direct Thread Mount 1/2x28
DIRECT THREAD MOUNT	72SATM12	Direct Thread Mount 5/8x24
DIRECT THREAD MOUNT	72SATM02	Direct Thread Mount .5x28
DIRECT THREAD MOUNT	72SATM03	Direct Thread Mount 5/8x24
DIRECT THREAD MOUNT	72SATM04	Direct Thread Mount 7/16x24
DIRECT THREAD MOUNT	72SATM05	Direct Thread Mount .5x32
DIRECT THREAD MOUNT	72SATM06	Direct Thread Mount 9/16x24
DIRECT THREAD MOUNT	72SATM07	Direct Thread Mount 3/4x24
DIRECT THREAD MOUNT	72SATM08	Direct Thread Mount 3/4x24
DIRECT THREAD MOUNT	72SATM10	Direct Thread Mount 18Mx1
DIRECT THREAD MOUNT	72SATM11	Direct Thread Mount 18Mx1.5
MUZZLE BRAKE	72MB3381BK	.338 Muzzle Brake 3/4x24
MUZZLE BRAKE	72MB3382BK	.338 Muzzle Brake 5/8x24
MUZZLE BRAKE	72MB3383BK	.338 Muzzle Brake 18Mx1
MUZZLE BRAKE	72MB3384BK	.338 Muzzle Brake 18Mx1.5
QD MOUNT	72SAQD01BK	QD Mount
TOOL	72SAUT01	Universal BLACKHAWK! Suppressor Tool

Pistol Suppressor  
3-Lug Adapter.338 Muzzle Brake  
5/8x245.56mm Flash  
Suppressor 1/2x28.5x28 Pistol  
Suppressor Piston.5x28 S&W M&P 22  
Compact Adapter1/4" Thread  
Spacer .5x28Universal BLACKHAWK!  
Suppressor Tool

BIPODS

**SPORTSTER™ TRAVERSETRACK™ BIPOD**

- Durable all-metal construction with robust tubular legs
- Horizontal traverse for smooth target acquisition and tracking
- Pivot action for level shooting on uneven terrain
- Rapid-adjust lever lock
- Spring-return telescoping legs
- Easily attaches to sling swivel stud

Part Number	Description	Color	Size
71BP09BK	TraverseTrack Bipod	Black	6"-9"
71BP10BK	TraverseTrack Bipod	Black	9"-13"
71BP11BK	TraverseTrack Bipod	Black	13.5"-23"
71BP16BK	TraverseTrack Bipod	Black	14.5"-29.25"



**SPORTSTER™ BIPOD**

- Compact and lightweight design
- No-rust anodized legs with increased spring tension
- Spring-return telescoping legs
- Unshakable prone and bench shooting
- Easily attaches to sling swivel

Part Number	Description	Color	Size
71BP03BK	Sportster Bipod	Black	6"- 9"
71BP02BK	Sportster Bipod	Black	9"-13"



## SPORTSTER™ PIVOT BIPOD

- Compact and lightweight design
- Pivot eliminates rifle canting on uneven terrain
- Rapid-adjust pivot lever
- No-rust anodized legs with increased spring tension
- Spring-return telescoping legs
- Unshakable prone and bench shooting
- Easily attaches to sling swivel

Part Number	Description	Color	Size
71BP05BK	Sportster Pivot Bipod	Black	6"-9"
71BP06BK	Sportster Pivot Bipod	Black	9"-13"
71BP07BK	Sportster Pivot Bipod	Black	13.5"-23"
71BP08BK	Sportster Pivot Bipod	Black	14.5"-29.25"



## SPORTSTER™ BIPOD PICATINNY RAIL ADAPTER

- Attach a bipod to any firearm with a Picatinny rail
- Easy to attach and detach

Part Number	Description	Color
71RA01BK	Sportster Bipod Picatinny Rail	Black



## SPORTSTER™ MULTI-LEVEL SANDBAG

- Easily transforms into different configurations
- Pre-filled sandbag
- 6.5"L x 5.5"W x 4.5"H (stacked), 12.5"L x 5.5"W x 2.25"H (flat)
- Weight: 5.76 lbs.

Part Number	Description	Color
74SB00BK	Sportster Multi-Level Sandbag	Black



FIXED BLADE KNIVES

**TATANG™**

- Savage cutting power of a traditional Filipino barong in a leaner, more versatile package
- Pistol-grip-style handle with weight-forward blade gives it tremendous reach and chopping power
- Blade length is 8.6"/218mm; Overall length is 13.5"/343mm
- Blade material is 1085C high-carbon tool steel with black epoxy finish
- Plain or partially serrated edge
- Injection-molded co-polymer handle with textured panels
- Injection-molded nylon sheath with mounting plates for PALS/MOLLE or drop-leg platform



Part Number	Description	Color
15TT10BK	Tatang Serrated	Black

**GIDEON™ TANTO**

- Modified "tanto" design for piercing or slashing
- The blade is constructed of AUS8A stainless steel with a black Ti-Nitride finish
- Blade length is 5"/127mm; Overall length is 10.25"/260mm
- CNC-machined textured G-10 handle scales
- Injection-molded nylon sheath with mounting plates for PALS/MOLLE or drop-leg platform attachment



Part Number	Description	Color
15TP00BK	Gideon Drop Point	Black

**UK-SFK™**

- Features a broad, symmetrical blade for exceptional edge geometry, point strength and penetration
- Comes complete with an integrated crossguard and distinctive full-tang handle design
- Blade length is 6.22"/158mm; Overall length is 11.38"/289mm
- D-2 tool steel blade with black epoxy powder coating or brushed satin finish
- Textured G-10 handle scales
- Injection-molded nylon sheath with mounting plates for PALS/MOLLE or drop-leg platform attachment



Part Number	Description	Color
15UK00SL	UK-SFK™	Satin



## FOLDING KNIVES

### CQD™ MARK I™ TYPE E MANUAL FOLDER

- Integrated button-lock, secondary safety, recessed belt/cord cutter and carbide glass breaker
- Blade length is 3.75"/95mm; Overall length is 9.5"/241mm
- AUS8A stainless steel blade with black PVD coating
- Edge is plain or partially serrated
- Injection-molded, reinforced nylon handle with 420J stainless steel liners
- Pocket clip for right- or left-side, tip-down carry



Part Number	Description	Color
15M111BK	CQD™ Mark I™ Type E Manual Folder Serrated	Black

### HAWKHOOK™

- Blade locks open via a stout frame-lock mechanism in the handle
- Lanyard hole, glass breaker, wire stripper, bottle opener and flat screwdriver/pry tip
- Recessed seat belt/cord cutter and ambidextrous thumb stud
- Blade length is 2.25"/57mm; Overall length is 5.5"/140mm
- AUS8A stainless steel blade with matte bead-blast finish
- Combination plain/partially serrated edge
- 420J stainless steel handle with textured nylon scale
- Pocket clip for right-side, tip-down carry



Part Number	Description	Color
15HH11SL	HawkHook	Silver

### BE-WHARNED™

- Wharncliffe blade design utilizes a sturdy liner-lock mechanism for secure weapon handling
- Blade length is 3.4"/86mm; Overall length is 7.85"/199mm
- AUS8A stainless steel blade with a satin finish
- Textured G-10 handle scales with nested 420J stainless steel liners
- Pocket clip for right- or left-side, tip-up or tip-down carry



Part Number	Description	Color
15BW01SL	Be-Wharned	Silver

### POINT MAN™

- Ergonomic handle, distinctive spearpoint blade, improved lock geometry and high-strength mechanism
- Blade length is: 3.4"/86mm; Overall length is 7.8"/198mm
- AUS8A stainless steel blade with black PVD coating
- Plain or partially serrated edge
- G-10 handle scales with nested 420J stainless steel liners



Part Number	Description	Color
15PM01BK	Point Man Plain	Black



BAGS

**GO BOX AMMO BAG**

- Roll-up/down lid for easy access and secure transport
- Full wraparound carry handles for superior weight support
- Heavy-duty D-rings for shoulder strap attachment
- External utility pouch for mag loaders or other small items
- Loop patch to attach content identifiers
- Go Box 30 has the same volume as a single .30 cal ammo can (22GB01)
- Go Box 50 has the same volume as a single .50 cal ammo can (22GB02)
- Dimensions: Go Box 30: 7"L x 4.5"W x 10"D  
Go Box 50: 8.5"L x 6"W x 10.5"D



Part Number	Description	Color
22GB01CT	Go Box 30 Ammo Bag	Coyote Tan
22GB02BK	Go Box 50 Ammo Bag	Black

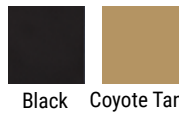

**BATTLE BAG**

- Constructed of 1000 denier nylon with reinforced stitching
- Full wraparound shoulder strap for superior weight support
- High-quality YKK® zippers with easy-grip pull tabs
- Stow-away waist strap for stability
- Internal elastic loops for chem-lights
- Internal hook & loop section for handgun, mag or other modular pouches
- Two dividers create three internal sections
- External zippered accessory pocket with elastic securing bands holds three magazines
- External zippered pouches hold GPS, phone, etc.
- Map pocket inside storm flap with side-release closure
- Internal pouch for handheld radio with antenna access
- Dimensions: 11"L x 5"W x 10"D, Map pocket: 9.5" x 13", External pouch: 4" x 5"



Part Number	Description	Color
60BB02BK	Battle Bag	Black



## ADVANCED TACTICAL BRIEFCASE

- Constructed of 1000 denier nylon with reinforced stitching and YKK® zippers with easy-grip pull tabs
- Waterproof internal lining protects contents
- Robust shoulder strap and carry handle
- Two hook & loop patches and removable vinyl ID window
- Padded hook & loop-secured laptop pocket
- External laptop access through waterproof zipper
- Three easy-access external pockets for cell phone, PDA, etc.
- Rear slot for pull-handle access (compatible with all wheeled luggage)
- Clear map case on inside of outer flap
- Five additional internal compartments
- Dimensions: 13"L x 16"W x 5"D = 610 cu. in./10 L

Part Number	Description	Color
61BC01BK	Advanced Tactical Briefcase	Black



## CIA GARMENT TRAVEL BAG

- Constructed of 1000 denier nylon with reinforced stitching
- High-quality YKK® zippers with easy-grip pull tabs
- Heavy-duty top and carry crossbars
- Top and folded middle carry handles with fighter grip handle
- Dual side-release securing straps when folded
- Zip-up and side-release attachments for internal clothing cover
- Internal zipper compartments
- Protective, removable shoe pouch
- Two external pockets for separating clean and soiled clothing
- Dimensions: Main compartment: 25"L x 43"W x 5"D

Part Number	Description	Color
20GB00BK	CIA Garment Travel Bag	Black



### ENHANCED PRO SHOOTER'S BAG

- Constructed of 1000 denier nylon with reinforced stitching
- Full wraparound carry handles for superior weight support
- Detachable shoulder strap with non-slip pad
- High-quality YKK® zippers with easy-grip pull tabs
- Zippered utility pockets at both ends
- Dimensions: Total: 7"L x 17"W x 12.5"D = 1488 cu. in.



Part Number	Description	Color
80SB06BK	Enhanced Pro Shooter's Bag	Black

### PRO TRAINING BAG

- Constructed of 1000 denier nylon with reinforced stitching
- Full wraparound carry handles for superior weight support
- Adjustable, detachable shoulder strap with non-slip shoulder pad
- High-quality YKK® zippers with easy-grip pull tabs
- Two external mesh pockets
- Dimensions: Total: 19"L x 10"W x 12"D = 2280 cu. in.



Part Number	Description	Color
20SP00BK	Pro Training Bag	Black

### BLOCK GO BAG

- Seven removable heavy-duty mesh interior pouches with clear windows to label contents
- Multiple carry handles
- Padded, removable shoulder straps for backpack or sling pack configuration
- Shoulder straps can be stowed inside padded back panel
- Internal and external S.T.R.I.K.E.® webbing for attaching pouches or accessories
- External zipper pocket and various lash-down points
- Three-sided zipper allows the main compartment to be fully opened for bag to lay flat or hung vertically
- Dimensions: 18"L x 9"W x 4.5"D, Interior Pouches 1 Each - 8.75"L x 8"W x 3"D, 2 Each - 8.75"L x 6"W x 3"D, 4 Each - 4"L x 4"W x 3"D



Part Number	Description	Color
22GB00BK	Block Go Bag	Black



**CROWD CONTROL BAG**

- Constructed of 1000 denier nylon with reinforced stitching
- Full wraparound carry handles for superior weight support
- Adjustable, removable shoulder strap
- High-quality YKK® zippers with easy-grip pull tabs
- Reinforced with polymer stiffeners
- ID panel on front pocket
- Padded helmet compartment
- External pouches and straps to secure baton or flashlight
- Dimensions: Total: 13”L x 11”W x 35”D = 5005 cu. in.  
 Main compartment: 21.5”L x 11”W x 13”D  
 Helmet compartment: 13.5”L x 11”W x 13”D

Part Number	Description	Color
20CC00BK	Crowd Control Bag	Black

### POLICE EQUIPMENT BAG

- Constructed of 1000 denier nylon with reinforced stitching
- Full wraparound carry handles for superior weight support
- Reinforced with internal polymer stiffeners
- Adjustable, removable shoulder strap
- Heavy-duty lockable YKK® zippers with easy-grip pull tabs
- Fully padded lid
- Two external zippered pouches, three open-top pouches and two straps for batons or lights
- Two internal zippered pouches and pen holder slots
- Dimensions: Total: 7.5"L x 12"W x 18.5"D = 5005 cu. in.  
 Two external pouches: 8"L x 1"W x 5.5"D  
 Two internal pouches: 5.5"L x 1"W x 4"D



Part Number	Description	Color
20PE00BK	Police Equipment Bag	Black

### CZ GEAR BAG

- Constructed of 1000 denier nylon with reinforced stitching
- Full wraparound carry handles for superior weight support
- High-quality YKK® zippers with easy-grip pull tabs
- Adjustable shoulder strap with reversible, non-slip shoulder pad
- Dimensions: Total: 33.5"L x 16"W x 15"D = 8040 cu. in.



Part Number	Description	Color
20CZ00BK	CZ Gear Bag	Black

### MOBILE OPERATION BAG

- Constructed of 1000 denier nylon with reinforced stitching
- Full wraparound carry handles for superior weight support
- High-quality YKK® zippers with easy-grip pull tabs
- Two padded, detachable shoulder straps
- External lockdown zipper flap
- Heavy-duty D-rings for securing external items and shoulder straps
- 3,850 cu. in.(total)
- Total: 24"L x 12"W x 9"D = 3850 cu. in.  
 One large pocket: 22"L x 10"W x 2"D, Two small pockets: 10.5"L x 10"W x 2"D



Part Number	Description	Color
20MOB2BK	Mobile Operation Bag, MD	Black





### MOBILE OPERATION BAG

- Constructed of 1000 denier nylon with reinforced stitching
- Full wraparound carry handles for superior weight support
- High-quality YKK® zippers with easy-grip pull tabs
- Two padded, detachable shoulder straps
- External lockdown zipper flap
- Heavy-duty D-rings for securing external items and shoulder straps
- 5,500 cu. in. (total)
- Dimensions: Total: 27”L x 14”W x 10”D  
 Large pocket: 24”L x 12”W x 3”D  
 Two Small Pockets: 12”L x 12”W x 3”D



Part Number	Description	Color
20MOB3BK	Mobile Operation Bag, L	Black

### ENHANCED DIVER’S TRAVEL BAG

- Constructed of 1000 denier nylon with reinforced stitching
- Extended handle for towing
- .375” closed-cell foam padding
- High-quality YKK® zipper with easy-grip pull tabs
- Available with inline-skate wheels or soft bottom, backpack straps and no wheels
- Dimensions: Total: 16”L x 11”W x 26.5”D = 7350 cu. in.



Part Number	Description	Color
21DT03BK	Enhanced Diver’s Travel Bag w/ wheels	Black
21DT00BK	Enhanced Diver’s Travel Bag w/o wheels	Black

### ENHANCED TACTICAL ROPE BAG

- Constructed of Type 4 nylon webbing
- Holds up to 200 feet of rope (rope not included)
- Drawstring sleeve for full bag closure
- Drawstring pocket holds excess drawstring
- Quick-release buckle belt attachment
- Grommets on bottom of bag for drainage
- External pocket for carabiners
- Quick-disconnect leg straps with high-visibility red pull tabs
- Dimensions: 22”L x 5.5”W x 8”D



Part Number	Description	Color
20TR03BK	Enhanced Tactical Rope Bag	Black

### MEDIUM A.L.E.R.T.™ BAG

- Constructed of 1000 denier nylon with reinforced stitching
- Zippered mesh dividers in all compartments
- Top dual-access (from outside or inside) compartment
- External compression straps stabilize load
- Hideaway pull handle and full wraparound carry handles for superior weight support
- Heavy-duty lockable YKK® zippers with easy-grip pulls
- Durable in-line skate wheels and reinforced corners
- Padded top pockets fold flat when not in use
- Dimensions: Total: 30"L x 16"W x 14"D = 6720 cu. in.



Part Number	Description	Color
20L004BK	Medium A.L.E.R.T. Bag	Black

### A.L.E.R.T.™ BAG

- Constructed of 1000 denier nylon with reinforced stitching
- Hideaway pull handle and full wraparound carry handles for superior weight support
- Heavy-duty lockable YKK® zippers with easy-grip pull tabs
- Large U-shaped, hinge-type lid for easy access
- Two padded end-cap handles for two-person carry
- Nine internal mesh pouches for gear storage
- Four clear ID insert pockets (two on top and one at each end)
- Reinforced corners and stiffeners on bottom
- Available with inline-skate wheels or soft bottom, backpack straps and no wheels
- Dimensions: Total: 43"L x 15"W x 13"D = 8385 cu. in.



Part Number	Description	Color
20L003BK	A.L.E.R.T. Bag w/ wheels	Black

### SPORTSTER® SHOOTER'S BAG

- Constructed of tight-weave, heavyweight 600 denier polyester with thick PVC laminate for stability
- Dual-density foam with internal open-cell foam for protection and external closed-cell foam for impacts
- Two large dual-zippered compartments and one slash pocket
- Two internal pockets hold two handguns
- Internal mag pockets hold magazines securely
- Multiple rows of S.T.R.I.K.E.® webbing for attaching pouches or accessories
- Dimensions: 13"L x 9"H x 4.5"D



Part Number	Description	Color
73SB00BK	Sportster Shooter's Bag	Black



## A.L.E.R.T.™ 5 BAG

- Constructed of 1000 denier nylon with reinforced stitching
- External compression straps stabilize load
- Hideaway pull handle and full wraparound carry handles for superior weight support
- Removable daisy-chain handle
- Large U-shaped, hinge-type lid for easy access
- Multiple heavy-duty D-rings for securing external/internal items or palletizing
- Two padded end-cap handles for two-person carry
- Durable inline-skate wheels and reinforced corners and stiffeners on bottom
- Multiple rows of S.T.R.I.K.E.® webbing for attaching pouches or accessories
- Large 33" x 14" weapon sleeve with heavy padding to protect long guns
- Three external clear window pockets for manifesting, content inventory or identification
- Dimensions: Total: 35"L x 21.5"W x 17"D = 9684.5 cu. in.,  
Main compartment: 34"L x 18"W x 14"D = 8568 cu. in.,  
External compartment: 29"L x 11"W x 3.5"D = 1116.5 cu. in.



Part Number	Description	Color
20L005BK	A.L.E.R.T. 5 Bag	Black

## SPORTSTER® PISTOL RANGE BAG

- Constructed of tight-weave, heavyweight 600 denier polyester with thick PVC laminate for stability
- Dual-density foam with internal open-cell foam for protection and external closed-cell foam for impacts
- Main internal pocket with dual-slider opening for easy access to contents
- Two external slash pockets hold magazines and other small items
- Includes two flannel-lined rugs to protect handgun inside main compartment
- Multiple rows of S.T.R.I.K.E.® webbing for attaching pouches or accessories
- Dimensions: 16" L x 9" H x 8" D



Part Number	Description	Color
74RB02BK	Sportster Pistol Range Bag	Black

## SPORTSTER® DELUXE RANGE BAG

- Removable Gun rug pistol pouch with Internal soft fabric to protect firearm
- Dual-density foam with internal open-cell foam for protection and external closed-cell foam for impacts
- Wraparound tactical web handles for superior weight support
- Heavy seam binding with two rows of locked stitching for durability
- Self-healing, heavy-duty, oversized coil zipper
- Integral pockets to hold two handguns
- Multiple internal pockets for organizing magazines or accessories
- Multiple rows of S.T.R.I.K.E.® webbing for attaching pouches or accessories
- Dimensions: 15 L x 11"W x 10"D



Part Number	Description	Color
74RB01BK	Sportster Deluxe Range Bag	Black

PACKS

**NEW! STAX™ PACK**

- Large, fleece-lined valuables pocket is deep enough to hold the largest smart phones
- Loop-lined MOLLE in main compartment for easy attachment of pouches and other accessories
- YKK zippers with wide tabs for reliable opening and closing
- Constructed of rugged 500D nylon
- Padded compartment can hold a large laptop or a hydration reservoir
- Built-in port door for easy access to gear

Part Number	Description	Color
60ST01BK	STAX PACK EDC (Every Day Carry)	Black
60ST01CT	STAX PACK EDC (Every Day Carry)	Coyote Tan
60ST01BG	STAX PACK EDC (Every Day Carry)	Black/Gray
60ST03BK	STAX PACK 3-DAY	Black
60ST03CT	STAX PACK 3-DAY	Coyote Tan
60ST03BG	STAX PACK 3-DAY	Black/Gray



**NEW! STINGRAY™ PACK**

- Large, fleece-lined valuables pocket is deep enough to hold the largest smart phones
- Loop-lined MOLLE in main compartment for easy attachment of pouches and other accessories
- YKK zippers with wide tabs for reliable opening and closing
- Constructed of rugged 500D nylon
- Padded compartment can hold a large laptop or a hydration reservoir
- EVA molded side wings for added protection of gear

Part Number	Description	Color
60SR01BK	STINGRAY PACK EDC (Every Day Carry)	Black
60SR01CT	STINGRAY PACK EDC (Every Day Carry)	Coyote Tan
60SR01BG	STINGRAY PACK EDC (Every Day Carry)	Black/Gray
60SR02BK	STINGRAY PACK 2-DAY	Black
60SR02CT	STINGRAY PACK 2-DAY	Coyote Tan
60SR02BG	STINGRAY PACK 2-DAY	Black/Gray
60SR03BK	STINGRAY PACK 3-DAY	Black
60SR03CT	STINGRAY PACK 3-DAY	Coyote Tan
60SR03BG	STINGRAY PACK 3-DAY	Black/Gray





## CYANE™ DYNAMIC PACK

- Constructed of denier nylon (solid colors) or CORDURA® nylon (MultiCam®)
- Removable 3-D mesh padded back panel and carry handle with lash loops on top of pack
- Six adjustable 3/4" compression straps
- Easy-grip zipper pulls and removable padded shoulder straps
- Multiple rows of S.T.R.I.K.E.® webbing: seven on back, four on each side, and three on the front
- One slash pocket on main compartment and two on front compartment
- Zippered pocket (84 cu. in.) on front compartment with two rows of S.T.R.I.K.E.® webbing
- Main compartment is 650 cu. in. and beavertail-style compartment is 595 cu. in.
- Hydration pocket with three elastic-covered tube ports accommodates 100-oz. hydration reservoir
- Dimensions: 16.5"H x 8.5"W x 12"D,  
Main Compartment: 16.5"H x 8.5"W x 4.5"D



Part Number	Description	Color
60CD00BK	Cyane Dynamic Pack	Black
60CD00CT	Cyane Dynamic Pack	Coyote Tan
60CD00MC	Cyane Dynamic Pack	MultiCam®



## YOMP™ PACK

- Constructed of durable 500 denier nylon with a spring steel frame for flexible, lightweight structure
- Accommodates 100-oz. hydration reservoir
- High-quality zippers with large zipper pulls
- Durable quick-release buckles and integral key clasp
- Multiple rows of S.T.R.I.K.E.® webbing for attaching pouches or accessories
- Padded shoulder straps with non-slip material to keep weapon sling in place
- Adjustable sternum strap and three-point hip belt for comfort under heavy load
- Thick lumbar pad on waist belt for load-bearing support
- Adjustable external compression straps accommodate various loadouts
- Air vent support panel to create load separation and prevent load shifting
- Attachment ports on bottom for external gear storage
- Two internal padded side compartments with mesh gearkeeper gussets
- Dimensions: 18"L x 12"W x 7"D (main comp.), 15.5"L x 1.5"W x 5"D (external side comps.), 12"L x 5"W x 1"D (internal mesh pockets), 15"L x 12"W x 1"D (internal hydration sleeve), 7"L x 9"W x 1"D (top flap comp.)



Part Number	Description	Color
60YP00RGCT	YOMP Pack	Green/Tan



### ULTRALIGHT 3-DAY ASSAULT PACK

- Constructed of lightweight, high-tenacity 210/330 denier nylon and 210 denier ripstop nylon (solid colors)
- Accommodates 100-oz. hydration reservoir
- High-quality YKK® zippers with easy-grip pull tabs
- Easy-access main compartment with front pocket and map pocket
- Multiple rows of S.T.R.I.K.E.® webbing for attaching pouches or accessories
- Four adjustable external compression straps accommodate various loadouts
- Five internal tie-down loops
- Padded shoulder straps and removable heavy-duty waist belt
- Heavy-duty D-rings for securing external items
- Loop fastener on front for ID patch attachment
- Dimensions: Inner Main Compartment: 20"L x 13"W x 6"D  
Top-Front Pocket: 14.5"L x 12.5"W x 2.5"D
- Cubes: 2000 cu. in. / 37 L



Part Number	Description	Color
603D08BK	Ultralight 3-Day Assault Pack	Black
603D08CT	Ultralight 3-Day Assault Pack	Coyote Tan
603D08MC	Ultralight 3-Day Assault Pack	MultiCam®



### 3-DAY ASSAULT™ PACK

- Constructed of 1000 denier nylon with reinforced stitching
- Accommodates 100-oz. hydration reservoir
- Sleeping bag straps and padded shoulder straps and heavy-duty D-rings for securing external items
- High-quality YKK® zippers and easy-grip pull tabs
- Reinforced drag/carry handle
- Removable elasticized sternum strap with silent release buckle and padded waist belt
- IVS™ (Intercooler Venting System) back panel for ventilation
- Dimensions: Main Compartment: 20"L x 13"W x 6"D  
Front Compartment: 14.5"L x 12.5"W x 2.5"D
- Cubes: 2000 cu. in. / 37 L

Part Number	Description	Color
603D00BK	3Day Assault Pack	Black
603D00DE	3Day Assault Pack	Desert Tan





### SPECIAL OPERATIONS MEDICAL BACKPACK

- Constructed of 1000 denier nylon with reinforced stitching
- Accommodates 100-oz. hydration reservoir
- Heavy-duty lockable YKK® zippers with easy-grip pull tabs
- Contour-padded shoulder straps and waist belt
- Robust grab handle and metal grommet at bottom of pack for drainage
- Adjustable external compression straps accommodate various loadouts
- Internal pockets made of urethane-coated mesh
- Individual medical gear compartments
- Padded back and internal tri-fold flap

Dimensions: 18”L x 13”W x 7.5”D = Cubes: 2225 cu. in.



Part Number	Description	Color
60MP00BK	Special Operations Medical Backpack	Black
60MP00DE	Special Operations Medical Backpack	Desert Tan
60MP00OD	Special Operations Medical Backpack	Olive Drab



### S.T.O.M.P. II™ MEDICAL COVERAGE PACK (JUMPABLE)

- Constructed of 1000 denier nylon with reinforced stitching
- Breathable closed-cell foam padding
- Accommodates two 100-oz. hydration reservoirs
- Webbing on underside for accessory packs or medic/sleeping rolls
- Adjustable shoulder straps, web belt and sternum strap
- Two robust grab handles and metal grommet at bottom of pack for drainage
- Adjustable external compression straps accommodate various loadouts
- Internal elastic stays and keepers
- External hook & loop strip
- Drop pouches with rigging for jumps
- Several flat netted zipper pockets
- Includes S.T.O.M.P.™ Medical Pack Accessory Pouch with Red Handle and S.T.O.M.P. Medical Pack Accessory Pouch with Blue Handle for storing medical supplies
- Dimensions: 20”L x 13”W x 6”D = 2470 cu. in.



Part Number	Description	Color
60MP01BK	S.T.O.M.P. II Medical Coverage Pack	Black
60MP01DE	S.T.O.M.P. II Medical Coverage Pack	Desert Tan
60MP01OD	S.T.O.M.P. II Medical Coverage Pack	Olive Drab



### VELOCITY X3 JUMP PACK

- Constructed of 1000 denier nylon with reinforced stitching
- Accommodates 100-oz. hydration reservoir
- Removable heavy-duty waist belt and removable, adjustable sternum strap
- Padded shoulder straps with dual-adjustment metal hardware
- Heavy-duty D-rings for securing external items
- Integrated single-point release harness
- Pull-out protection flap with S.T.R.I.K.E.® webbing on bottom of pack
- Easy-access main compartment with front pocket and map pocket
- Four internal equipment tie-down straps, eight internal tie-down loops and eight external loops
- Dimensions: Main Compartment: 22”L x 13”W x 8.5”D,  
Top-Front Pocket: 18”L x 13”W x 2”D



Part Number	Description	Color
603D09CT	Velocity X3 Jump Pack	Coyote Tan

### HYDRATION PACKS

#### S.T.R.I.K.E.® PREDATOR™ PACK

- Constructed of 1000 denier nylon with reinforced stitching
- Includes 100-oz. BLACKHAWK!® hydration reservoir
- Drink system protected by Microban® antimicrobial technology
- Bite Me® bite valve and patent-pending quick-disconnect system
- Multiple rows of S.T.R.I.K.E.® webbing for attaching pouches or accessories
- Padded, contour-fit shoulder harness with sternum strap
- Reinforced drag/carry handle
- IVS™ (Intercooler Venting System) back panel for ventilation
- Compartment for second optional hydration reservoir
- Dimensions: Main Compartment: 16”L x 9.5”W x 2.5”D,  
Front Compartment: 9”L x 9.5”W x 2.5”D



Part Number	Description	Color
65SP00BK	S.T.R.I.K.E. Predator Pack	Black

#### S.T.R.I.K.E.® CYCLONE™ PACK

- Constructed of 1000 denier nylon with reinforced stitching
- Includes 100-oz. BLACKHAWK!® hydration reservoir
- Drink system protected by Microban® antimicrobial technology
- Bite Me® bite valve and patent-pending quick-disconnect system
- Multiple rows of S.T.R.I.K.E.® webbing for attaching pouches or accessories
- Tube cover conceals, insulates and protects water tube from sunlight
- Anodized D-rings and quick-cinch buckles for attaching pouches
- Reinforced waist belt with additional attachment points
- Padded, contour-fit shoulder straps with sternum strap
- Rubber drag handle and metal grommet at bottom of pack for drainage
- Large compartment with internal pouch for radio packs and three antenna ports w/flaps
- Dimensions: Main Compartment: 19”L x 11”W x 5.5”D,  
Front-Top Compartment: 9.5”L x 7”W x 3”D,  
Front-Bottom Compartment: 11”L x 11.5”W x 3.5”D



Black



Coyote Tan



Olive Drab



Part Number	Description	Color
65SC00BK	S.T.R.I.K.E. Cyclone Pack	Black
65SC00CT	S.T.R.I.K.E. Cyclone Pack	Coyote Tan
65SC00OD	S.T.R.I.K.E. Cyclone Pack	Olive Drab



## BARRAGE™ PACK

- Constructed of 1000 denier nylon with reinforced stitching
- Includes 100-oz. BLACKHAWK!® hydration reservoir
- Drink system protected by Microban® antimicrobial technology
- Bite Me® bite valve and patent-pending quick-disconnect system
- High-quality YKK® zippers and easy-grip pull tabs
- Multiple rows of S.T.R.I.K.E.® webbing for attaching pouches or accessories
- Wide opening for easy access to contents
- 3-D mesh back panel with frame and external hydration reservoir access
- Robust waist belt with additional S.T.R.I.K.E.® attachment points
- Dual antenna ports and several internal pockets and dividers
- Dimensions: Main Compartment: 17" L x 13" W x 7" D,  
Front Compartment: 13" L x 12.5" W x 2.75" D



Part Number	Description	Color
65BG00BK	Barrage Pack	Black

## TITAN™ PACK

- Constructed of heavy-duty 1000 denier nylon with reinforced stitching
- Includes 100-oz. BLACKHAWK!® hydration reservoir
- Drink system protected by Microban® antimicrobial technology
- Bite Me® bite valve and patent-pending quick-disconnect system
- High-quality YKK® zippers and easy-grip pull tabs
- Multiple rows of S.T.R.I.K.E.® webbing for attaching pouches or accessories
- 3-D mesh back panel with frame
- Robust waist belt with additional S.T.R.I.K.E.® webbing
- Dual antenna ports and external hydration reservoir access
- Tie-down straps in main compartment and reinforced attachment system
- Includes Upright GP Pouch and Nalgene® Bottle Pouch
- Dimensions: Main Compartment: 20" L x 12.5" W x 7.5" D,  
Top Front Compartment: 14" L x 12.5" W x 2.75" D,  
Bottom Front Compartment: 6" L x 12.5" W x 3" D,  
Side Compartment: 8.25" L x 5" W x 3.75" D,  
Side Compartment: 9" L x 4" W x 2" D



Part Number	Description	Color
65TI00BK	Titan Pack	Black
65TI00CT	Titan Pack	Coyote Tan





HYDRATION

**TIDAL RAVE™ PACK**

- Includes 100-oz. BLACKHAWK!® hydration reservoir
- Drink system protected by Microban® antimicrobial technology
- Bite Me® bite valve and patent-pending quick-disconnect system
- Lightweight mesh shoulder harness
- Bungee retention system for extra clothes storage
- Dimensions: 18”H x 7.5”W x 1”D

Part Number	Description	Color
65TR00BK	Tidal Rave Pack	Black



**ANTIMICROBIAL HYDRATION RESERVOIR KIT**

- Microban® antimicrobial technology inhibits the growth of bacteria, mold and mildew
- 40” delivery tube includes a unique Bite Me® bite valve with on/off lever

Part Number	Description	Color
672556BK	100-oz. Reservoir	Black
672556CT	100-oz. Reservoir	Coyote Tan



**HYDRATION RESERVOIR BITE ME® BITE VALVE**

- Replacement Bite Me bite valve system gives 360-degree bite zone for easy hydration
- Ergonomic on/off lever lets you control the flow
- Locking 360-degree rotating connector for bite valve removal from drink tube

Part Number	Description	Color
67255300BK	Bite Me® Bite Valve	Black







LITTERS

**RAPIDFLEX™ MEDICAL LITTER**

- Constructed of heavy-duty, impermeable PVC tarpaulin
- Rolls up into small bundle for easy storage and deployment
- Stabilizing torso strap is constructed of 2" nylon webbing and adjusts to 76" with side-release buckle
- Six durable 2" nylon web loop handles (two on each side and one drag handle at each end)
- Combined strength of all four handles exceeds 1700 lbs.
- Drag weight exceeds 1600 lbs.

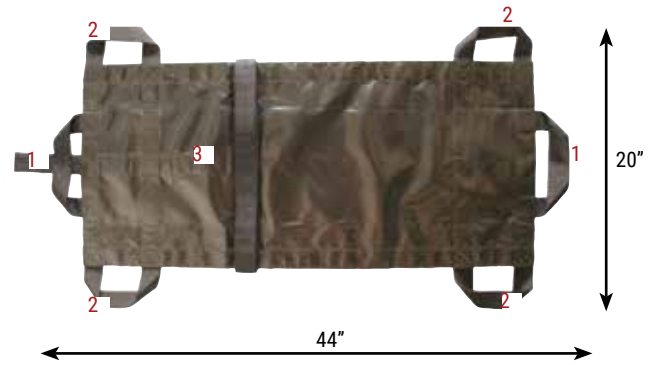

- 1 Reinforced top and bottom drag straps
- 2 Four side handles
- 3 Adjustable chest/waist straps
- 4 Adjustable leg straps

Part Number	Description	Color
20ML00BK	RapidFlex Medical Litter	Black

**FAST ATTACK TACTICAL LITTER**

- Heavy-duty, impermeable PVC tarpaulin material
- Six durable 2" nylon web loop handles (two handles on each side and one drag handle at each end)
- Combined strength of all four handles exceeds 1900 lbs.
- Drag weight exceeds 1800 lbs.
- Stabilizing torso strap constructed of 2" nylon webbing and adjusts to 76" with side-release buckle
- Angled stabilizing leg straps constructed of 2" nylon webbing and adjust to 32" with side-release buckles



Part Number	Description	Color
20ML01BK	Fast Attack Tactical Litter	Black

**MEDIC ROLL**

- Constructed of durable 1000 denier nylon
- Full wraparound carry handles for superior weight support
- Internal pleated vinyl pockets to store medical supplies
- Dimensions: 37"L x 13.5"W



Part Number	Description	Color
20EMR1BK	Medic Roll	Black

HANDGUN CASES

**DISCREET SOCOM PISTOL CASE**

- Fully modular pouches for custom configurations
- .375" closed-cell foam padding for weapon protection
- TalonFlex™ plastic inserts on top and bottom for stiffness
- High-quality YKK® zippers and dual sliders with full wraparound carry handles
- Universal holster and barrel pouch, sound suppressor pouch, double mag pouch and UTL light pouch
- Dimensions: 10"L x 13"W x 2.5"D



Part Number	Description	Color
66SS00BK	Discreet SOCOM Pistol Case	Black

**GUN RUG PISTOL POUCH**

- Constructed of 1000 denier nylon
- .375" closed-cell foam padding for weapon protection
- High-quality YKK® zippers and dual sliders for security and full wraparound carry handles
- Internal padded divider for weapons and accessories and elastic keeper for extra magazines
- Dimensions: 12"L x 8"W



Part Number	Description	Color
61GR01BK	Gun Rug Pistol Pouch	Black

**SPORTSTER® PISTOL RUG**

- Constructed of tight-weave, heavyweight 600 denier polyester with thick PVC laminate for stability
- Dual-density foam with internal open-cell foam for protection and external closed-cell foam for impacts
- Internal soft fabric protects firearm finish
- Wraparound tactical web handles for superior weight support
- Rugged tactical webbing on shoulder straps and contact points
- Heavy seam binding with two rows of locked stitching for durability
- Self-healing, heavy-duty, oversized coil zippers
- Fits most pistols and revolvers
- Dimensions: Small: 12.5"L x 8"W x 1.25"D (74PR01)  
Large: 15"L x 8"W x 1.25"D (74PR02)



Part Number	Description	Color	Size
74PR01BK	Sportster® Pistol Rug	Black	Medium
74PR02BK	Sportster® Pistol Rug	Black	Large



LONG GUN CASES AND MATS

**NEW! FOUNDATION™ RIFLE CASE**

- Laser-cut grid and loop panel for attaching accessories
- Reinforced, padded interior with MOLLE webbing
- 4 hook-and-loop straps to secure firearm
- Intergrated sleeve ideal for storing cleaning rods
- Tough 500D nylon construction



Part Number	Description	Color	Size
61FD30BK	Foundation Rifle Case	Black	30" wide
61FD30CT	Foundation Rifle Case	Coyote Tan	30" wide
61FD30BG	Foundation Rifle Case	Black/Gray	30" wide
61FD36BK	Foundation Rifle Case	Black	36" wide
61FD36CT	Foundation Rifle Case	Coyote Tan	36" wide
61FD36BG	Foundation Rifle Case	Black/Gray	36" wide
61FD45BK	Foundation Rifle Case	Black	45" wide
61FD45CT	Foundation Rifle Case	Coyote Tan	45" wide
61FD45BG	Foundation Rifle Case	Black/Gray	45" wide

**HOMELAND SECURITY DISCREET CASE**

- Double-stitched seam taping on raw edges with Box X-anchor stitching on handles
- Lightweight closed-cell foam padding does not absorb moisture
- Full-opening zipper for shooting mat configuration
- External zipper pocket lined with bed of hook & loop to attach any hook & loop pouches
- Includes removable Triple M16 Mag Pouch



Part Number	Description	Color	Size
65DC22BK	MP5 Case	Black	22" x 2" x 10"
65DC29BK	HK94 MP5 Case	Black	29" x 2" x 10"
65DC32BK	CAR15 Case	Black	32" x 2" x 13"
65DC35BK	CAR15/M4 Case	Black	35" x 2" x 10"
65DC40BK	M16 Case	Black	40" x 2" x 12"
65DC40DE	M16 Case	Tan	40" x 2" x 12"



**PADDED WEAPONS CASE**

- Double-stitched seam taping on raw edges with Box X-anchor stitching on handles
- Lightweight closed-cell foam padding does not absorb moisture
- Full-opening zipper for shooting mat configuration
- Removable, adjustable shoulder strap with non-slip shoulder pad
- Internal divider to carry up to two weapons side by side
- Large external utility pouch secured by hook & loop



Part Number	Description	Color	Size
61PW00BK	38" Padded Weapons Case	Black	38" x 3.5" x 14"
61PW01BK	44" Padded Weapons Case	Black	44" x 3.5" x 14"

### RIFLE CASE

- Padded .375" closed-cell foam absorbs shock but not water
- Double-stitched seam taping on raw edges with Box X-anchor stitching on handles
- Full-opening zipper for shooting mat configuration
- High-quality YKK® zippers and sliders
- Removable foam inserts and four external mag pouches with adjustable lids



Part Number	Description	Color	Size
64RC34BK	34" Rifle Case	Black	34" x 2.5" x 11.5"
64RC37BK	37" Rifle Case	Black	37" x 2.5" x 11.5"
64RC41BK	41" Rifle Case	Black	41" x 2.5" x 11.5"

### SCOPED RIFLE CASE

- Padded .375" closed-cell foam absorbs shock but not water
- Double-stitched seam taping on raw edges with Box X-anchor stitching on handles
- Full-opening zipper for shooting mat configuration
- Zippered cargo compartment for gear
- High-quality YKK® zippers



Part Number	Description	Color	Size
64SR51BK	51" Scoped Rifle Case	Black	51" x 2.5" x 10"

### WEAPON TRANSPORT CASE

- Constructed of durable 1000 denier nylon and .375" closed-cell foam
- Full-opening zipper for shooting mat configuration
- Removable, adjustable shoulder strap with non-slip shoulder pad
- Padded, removable divider for side-by-side weapon storage
- Fully padded external pocket with universal holster for pistol and accessories
- Dimensions: 41"L x 11"W x 3.5"D



Part Number	Description	Color	Size
66WT00BK	Weapon Transport Case	Black	41"

### SHOTGUN CASE

- Constructed of durable 1000 denier nylon and .375" closed-cell foam
- Removable, adjustable shoulder strap with non-slip shoulder pad
- Designed to hold standard stock 18" to 22" barrels
- High-quality YKK® zippers and sliders
- Dual-slider zippered utility pocket and pouches



Part Number	Description	Color	Size
64SG43BK	Shotgun Case	Black	43" x 2" x 8"



## LONG GUN SNIPER DRAG BAG

- Constructed of durable 1000 denier nylon and closed-cell foam
- Full-opening zipper for shooting mat configuration
- High-quality YKK® zippers and sliders
- Detachable shoulder straps for muzzle-up or muzzle-down carry
- Reinforced drag handle and front/rear cargo pouches with internal straps
- Loops for Ghillie attachment
- Internal weapon-securing straps and two internal utility pouches
- Dimensions: 51”L x 11”W x 3”D  
 Rear Cargo Pouch: 9.5”L x 12”W x 2”D  
 Front Cargo Pouch: 23”L x 8.5”W x 2”D



Part Number	Description	Color	Size
20DB01BK	Sniper Drag Bag	Black	51”
20DB01OD	Sniper Drag Bag	Olive	51”
20DB01DE	Sniper Drag Bag	Tan	51”



## STALKER DRAG MAT

- Constructed of durable 1000 denier nylon and closed-cell foam
- Removable, adjustable shoulder strap with non-slip shoulder pad
- Internal weapon-securing straps
- Elastic loops with protective flap hold 10 rounds of .308 ammo
- Internal data book pocket and open bottom design
- Dimensions: Closed 50.5”L x 9”W x 2”D



Part Number	Description	Color	Size
80DM00BK	Stalker Drag Mat	Black	50.5” x 32”
80DM00OD	Stalker Drag Mat	Olive	50.5” x 32”

## PRO-SHOOTERS MAT

- Constructed of durable 1000 denier nylon and closed-cell foam
- Hydration-compatible pouch with tube-routing system
- Removable, adjustable shoulder strap with non-slip shoulder pad and heavy-duty carry handle
- Non-slip shooting surface
- Dimensions: Closed 28”L x 8” Diameter



Part Number	Description	Color	Size
80CM00BK	Pro-Shooters Mat	Black	83” x 28”
80CM00OD	Pro-Shooters Mat	Olive	83” x 28”
80CM00DE	Pro-Shooters Mat	Tan	83” x 28”





### SPORTSTER® TACTICAL CARBINE CASE

- Tight-weave 600 denier polyester with thick PVC laminate and dual-density foam padding
- Holds carbines up to 36" long
- Four external mag pockets and two large accessory pockets for gear

Part Number	Description	Color	Size
74SG36BK	Sportster Tactical Carbine Case	Black	36" x 11.5" x 3"



### SPORTSTER® TACTICAL RIFLE CASE

- Tight-weave 600 denier polyester with thick PVC laminate and dual-density foam padding
- Holds rifles up to 42.5" long (74SG02) or 44" long (74SG03)
- Five external mag pockets and two large accessory pockets for gear

Part Number	Description	Color	Size
74SG02BK	Sportster Tactical Rifle Case-Small	Black	42.5" x 11.5" x 3"
74SG03BK	Sportster Tactical Rifle Case-Large	Black	44" x 12.5" x 3"



### SPORTSTER® SCOPED RIFLE CASE

- Tight-weave 600 denier polyester with thick PVC laminate and dual-density foam padding
- Holds scoped rifles up to 44" long (74SG44) or 48" long (74SG48)
- Multiple rows of S.T.R.I.K.E.® webbing for attaching pouches or accessories

Part Number	Description	Color	Size
74SG44BK	44" Sportster Scoped Rifle Case	Black	45" x 10" x 2"
74SG48BK	48" Sportster Scoped Rifle Case	Black	51.5" x 10" x 2"





**SPORTSTER® SHOTGUN CASE**

- Tight-weave 600 denier polyester with thick PVC laminate and dual-density foam padding
- Holds shotguns up to 52" long
- Multiple rows of S.T.R.I.K.E.® webbing for attaching pouches or accessories

Part Number	Description	Color	Size
74SG01BK	Sportster Shotgun Case	Black	53" x 8" x 2"

**SPORTSTER® MODULAR WEAPONS CASE**

- Tight-weave 600 denier polyester with thick PVC laminate and dual-density foam padding
- Modular discreet case with removable divider
- Internal S.T.R.I.K.E.® webbing for attaching pouches or accessories
- Includes Muzzle Retainer and Weapon Retainer

Part Number	Description	Color	Size
74SG04BK	Sportster Modular Weapons Case	Black	36" x 13" x 5"



Pouches not included



Pouches not included



POUCHES

**SIDE HYDRATION POUCH**

- Mount on side, back, front or backpack using Speed Clips™
- Drink system protected by Microban® antimicrobial technology
- Bite Me® bite valve and patent-pending quick-disconnect system
- Capacity is 40 oz./1 L
- Dimensions: 10”H x 7”W x 1.5”D

Part Number	Description	Color
65SH00BK	Side Hydration Pouch	Black
65SH00CT	Side Hydration Pouch	Coyote Tan



**VEHICLE QD MEDICAL POUCH**

- Mounts to most automobile headrests and some visors
- Quick detach feature allows instant removal from stowed position
- Red zipper pulls and grab handle identify the contents as medical supplies
- Loop panel on front of pouch allows attachment of additional hook back ID patches
- Made of high-quality materials such as 500D nylon and YKK zippers

Part Number	Description	Color
20VP00BK	Vehicle QD Medical Pouch	Black



**SERIES SINGLE PISTOL MAG POUCH**

- Hook & loop attachment
- Constructed of 500 denier nylon
- Holds single pistol magazine
- Adjustable lid accommodates various length magazines

Part Number	Description	Color
52HB01BK	Hook Backed Single Pistol Mag	Black
52HB01CT	Hook Backed Single Pistol Mag	Coyote Tan



**DOUBLE PISTOL MAG POUCH**

- Hook & loop attachment
- Constructed of 500 denier ripstop

Part Number	Description	Color
61ACDMBK	Hook Backed Double Pistol Mag	Black





### M16 MAG POUCH (HOLDS 2)

- Hook & loop attachment
- Constructed of 500 denier nylon
- Holds two 20- or 30-round magazines
- Reinforced bottom with metal grommets for drainage
- Adjustable lid accommodates various length magazines

Part Number	Description	Color
52HB00CT	Hook Backed Triple M16	Coyote Tan



### TRIPLE M16 MAG POUCH (HOLDS 3)

- Hook & loop attachment
- Holds three M16 magazines
- Constructed of 500 denier ripstop

Part Number	Description	Color
65MV01BK	Hook Backed Triple M16	Black
65MV01CT	Hook Backed Triple M16	Coyote Tan



### UNDER THE RADAR™ SECURITY POUCHES

- Incorporates Zero Trace® signal blocking technology
- Protects electronic devices from remote exploitation by blocking incoming and outgoing signals
- Helps prevent tracking of devices
- Shields RFID technology found in U.S. passports, driver's licenses, IDs and credit cards
- Constructed of 1050 denier nylon
- Electromagnetic interior lining blocks incoming or outgoing signals with roughly 33dbm of attenuation
- Adjustable hook & loop closure flap
- Foam padding for extra protection (except Cell Phone and Oversized Cell Phone Pouches)
- Vinyl window for business card or other identification (Passport Pouch only)

Part Number	Description	Dimensions	Color
61SC05BK	Under the Radar Oversized Cell Phone Pouch	5"W x 6.25"H	Black



### MOLLE 3700 POUCHES

- Mount to any S.T.R.I.K.E.® or PALS/MOLLE platform with integral straps
- Constructed of 500 denier nylon (solid colors) or 500 denier CORDURA® nylon (MultiCam®)



### SPEED CLIP™ 3800 POUCHES

- Speed Clips are the quickest, strongest and most convenient modular attachment system available
- Constructed of 1000 denier nylon (solid colors) or 1000 denier CORDURA® nylon (MultiCam®)



## PISTOL MAG POUCHES

### SINGLE PISTOL MAG POUCH

	Part Number	Description	Color
MOLLE	37CL06BK	STRIKE Single Pistol Mag	Black
	37CL06CT	STRIKE Single Pistol Mag	Coyote Tan
	37CL06MC	STRIKE Single Pistol Mag	MultiCam
	37CL06OD	STRIKE Single Pistol Mag	Olive Drab



### DOUBLE PISTOL MAG POUCH

	Part Number	Description	Color
MOLLE	37CL09BK	STRIKE Double Pistol Mag	Black
	37CL09CT	STRIKE Double Pistol Mag	Coyote Tan
	37CL09MC	STRIKE Double Pistol Mag	MultiCam
	37CL09OD	STRIKE Double Pistol Mag	Olive Drab







### DOUBLE PISTOL MAG POUCH WITH TALONFLEX

Part Number	Description	Color
37CL10BK	Double Pistol Magazine Pouch with Talon Flex	Black
37CL10CT	Double Pistol Magazine Pouch with Talon Flex	Coyote Tan
37CL10OD	Double Pistol Magazine Pouch with Talon Flex	Olive Drab
37CL10MC	Double Pistol Magazine Pouch with Talon Flex	Multicam



### M4/M16 POUCHES

#### M4/M16 SINGLE MAG POUCH (HOLDS 1)

	Part Number	Description	Color
MOLLE	37CL68BK	STRIKE Single M4/M16 Mag	Black
	37CL68CT	STRIKE Single M4/M16 Mag	Coyote Tan
	37CL68MC	STRIKE Single M4/M16 Mag	Multi Cam
	37CL68OD	STRIKE Single M4/M16 Mag	Olive Drab



#### M4/M16 SINGLE MAG POUCH (HOLDS 2)

	Part Number	Description	Color
MOLLE	37CL02BK	STRIKE M4/M16 Double Mag Holds 2	Black
	37CL02CT	STRIKE M4/M16 Double Mag Holds 2	Coyote Tan
	37CL02MC	STRIKE M4/M16 Double Mag Holds 2	MultiCam
	37CL02OD	STRIKE M4/M16 Double Mag Holds 2	Olive Drab



### M4/M16 STAGGERED MAG POUCH (HOLDS 2)

Part Number	Description	Color
37CL65BK	STRIKE M4/M16 Staggered Mag	Black
37CL65CT	STRIKE M4/M16 Staggered Mag	Coyote Tan
37CL65MC	STRIKE M4/M16 Staggered Mag	MultiCam
37CL65OD	STRIKE M4/M16 Staggered Mag	Olive Drab



### M4/M16 TRIPLE MAG POUCH (HOLDS 6)

Part Number	Description	Color
37CL04BK	STRIKE M4/M16 Triple Mag	Black
37CL04CT	STRIKE M4/M16 Triple Mag	Coyote Tan
37CL04MC	STRIKE M4/M16 Triple Mag	MultiCam
37CL04OD	STRIKE M4/M16 Triple Mag	Olive Drab



### M4/M16 DOUBLE MAG POUCH (HOLDS 4)

Part Number	Description	Color
37CL03BK	STRIKE M4/M16 Dble Mag	Black
37CL03CT	STRIKE M4/M16 Dble Mag	Coyote Tan
37CL03MC	STRIKE M4/M16 Dble Mag	Multi Cam
37CL03OD	STRIKE M4/M16 Dble Mag	Olive Drab



### TIER STACKED M16/M4/P MAG POUCH

- Holds two M16 magazines
- Stair-stepped configuration for easy access
- Open top with bungee retention
- Grommets for drainage

Part Number	Description	Color
37CL118BK	Tier Stacked M16 Mag	Black
37CL118CT	Tier Stacked M16 Mag	Coyote Tan
37CL118MC	Tier Stacked M16 Mag	MultiCam
37CL118OD	Tier Stacked M16 Mag	Olive Drab





### SUREFIRE® MAG POUCH (60 ROUND)

- Holds 60-round SureFire® magazine
- Adjustable lid
- Grommets for drainage

Part Number	Description	Color
37CL122BK	Surefire Mag Pouch 60 Rnd	Black
37CL122CT	Surefire Mag Pouch 60 Rnd	Coyote Tan
37CL122MC	Surefire Mag Pouch 60 Rnd	MultiCam
37CL122OD	Surefire Mag Pouch 60 Rnd	Olive Drab



### SUREFIRE® MAG POUCH (100 ROUND)

- Holds 100-round SureFire® magazine
- Adjustable lid
- Grommets for drainage

Part Number	Description	Color
37CL121BK	Surefire Mag Pouch 100 Rnd	Black
37CL121CT	Surefire Mag Pouch 100 Rnd	Coyote Tan
37CL121MC	Surefire Mag Pouch 100 Rnd	MultiCam
37CL121OD	Surefire Mag Pouch 100 Rnd	Olive Drab



## AK POUCHES

### AK47 DOUBLE MAG POUCH (HOLDS 4)

	Part Number	Description	Color
MOLLE	37CL88BK	STRIKE AK 47 Double Mag (holds 4)	Black
	37CL88CT	STRIKE AK 47 Double Mag (holds 4)	Coyote Tan
	37CL88MC	STRIKE AK 47 Double Mag (holds 4)	Multi Cam
	37CL88OD	STRIKE AK 47 Double Mag (holds 4)	Olive Drab



### AK SINGLE MAGAZINE POUCH

Part Number	Description	Color
37CL185BK	AK Single Magazine Pouch	Black
37CL185CT	AK Single Magazine Pouch	Coyote Tan
37CL185OD	AK Single Magazine Pouch	Olive Drab



SR25/M14/FAL POUCHES

**SR25/M14 Single Mag Pouch**

- Holds one SR25/M14 or similar 20-round 7.62x51 magazines
- Open top with bungee retention
- Grommets for drainage
  - S.T.R.I.K.E. webbing on front for attaching additional items
- Dimensions: 4.3”L x 3.14”W x 1.37”D

Part Number	Description	Color
37CL115BK	SR25/M14 Single Mag Case	Black
37CL115CT	SR25/M14 Single Mag Case	Coyote Tan
37CL115MC	SR25/M14 Single Mag Case	MultiCam
37CL115OD	SR25/M14 Single Mag Case	Olive Drab



**Tier Stacked SR25/M14 Mag Pouch**

- Holds two SR25/M14 or similar 20-round 7.62x51 magazines
- Stair-stepped configuration for easy access
- Open top with bungee retention
- Grommets for drainage
- S.T.R.I.K.E.® webbing on front for attaching additional items

Part Number	Description	Color
37CL119BK	Tier Stacked Mag M4/FAL	Black
37CL119CT	Tier Stacked Mag M4/FAL	Coyote Tan
37CL119MC	Tier Stacked Mag M4/FAL	MultiCam
37CL119OD	Tier Stacked Mag M4/FAL	Olive Drab



BELT FED AMMO POUCHES

**SAW POUCH**

Part Number	Description	Color
37CL28BK	SAW Pouch	Black
37CL28CT	SAW Pouch	Coyote Tan
37CL28OD	SAW Pouch	Olive Drab
37CL28MC	SAW Pouch	Multicam



**M-240 AMMO POUCH**

Part Number	Description	Color
37CL27BK	M-240 Ammo Pouch	Black
37CL27CT	M-240 Ammo Pouch	Coyote Tan
37CL27OD	M-240 Ammo Pouch	Olive Drab
37CL27MC	M-240 Ammo Pouch	Multicam





## PRECISION RIFLE AMMO POUCHES

### PRO MARKSMAN POUCH

- Securely holds 20 rounds of .308 ammunition
- Elastic band protects projectile tips (pen/pencil holder included)
- Side flaps have clear windows so range data can be displayed when opened
- Secured with silent, adjustable side-release buckles



	Part Number	Description	Color
MOLLE	37CL87BK	STRIKE Pro Marksman	Black
	37CL87CT	STRIKE Pro Marksman	Coyote Tan
	37CL87MC	STRIKE Pro Marksman	Multi Cam
	37CL87OD	STRIKE Pro Marksman	Olive Drab

## SHOTGUN AMMO POUCHES

### 18-ROUND POUCH

Part Number	Description	Color
37CL51BK	STRIKE Shotgun 18RND	Black
37CL51CT	STRIKE Shotgun 18RND	Coyote Tan
37CL51MC	STRIKE Shotgun 18RND	MultiCam
37CL51OD	STRIKE Shotgun 18RND	Olive Drab



## SUB-GUN MAG POUCHES

### TRIPLE MP-5 MAG POUCH

Part Number	Description	Color
37CL106BK	Triple MP-5 Magazine Pouch	Black
37CL106CT	Triple MP-5 Magazine Pouch	Coyote Tan
37CL106OD	Triple MP-5 Magazine Pouch	Olive Drab
37CL106MC	Triple MP-5 Magazine Pouch	Multicam





GRENADE POUCHES

**SMOKE GRENADE SINGLE POUCH**

Part Number	Description	Color	Dimensions
37CL14BK	STRIKE Smoke Grenade Single	Black	6"H x 3"W x 2"D
37CL14CT	STRIKE Smoke Grenade Single	Coyote Tan	6"H x 3"W x 2"D
37CL14MC	STRIKE Smoke Grenade Single	MultiCam	6"H x 3"W x 2"D
37CL14OD	STRIKE Smoke Grenade Single	Olive Drab	6"H x 3"W x 2"D

MOLLE



**SINGLE FRAG GRENADE POUCH**

Part Number	Description	Color
37CL12BK	Single Frag Grenade Pouch	Black
37CL12CT	Single Frag Grenade Pouch	Coyote Tan
37CL12OD	Single Frag Grenade Pouch	Olive Drab
37CL12MC	Single Frag Grenade Pouch	Multicam



**DOUBLE FRAG GRENADE POUCH**

Part Number	Description	Color
37CL13BK	Double Frag Grenade Pouch	Black
37CL13CT	Double Frag Grenade Pouch	Coyote Tan
37CL13OD	Double Frag Grenade Pouch	Olive Drab
37CL13MC	Double Frag Grenade Pouch	Multicam



**DOUBLE 4MM GRENADE POUCH**

Part Number	Description	Color
37CL22BK	Double 40mm Grenade Pouch	Black
37CL22CT	Double 40mm Grenade Pouch	Coyote Tan
37CL22OD	Double 40mm Grenade Pouch	Olive Drab
37CL22MC	Double 40mm Grenade Pouch	Multicam





### TRIPLE 40MM GRENADE POUCH

Part Number	Description	Color
37CL23BK	Triple 40mm Grenade Pouch	Black
37CL23CT	Triple 40mm Grenade Pouch	Coyote Tan
37CL23OD	Triple 40mm Grenade Pouch	Olive Drab
37CL23MC	Triple 40mm Grenade Pouch	Multicam



### SIX ROUND 40MM GRENADE POUCH

Part Number	Description	Color
37CL59BK	6 Round 40mm Grenade Pouch	Black
37CL59CT	6 Round 40mm Grenade Pouch	Coyote Tan
37CL59OD	6 Round 40mm Grenade Pouch	Olive Drab
37CL59MC	6 Round 40mm Grenade Pouch	Multicam



## FLASHBANG POUCHES

### FLASHBANG POUCH

	Part Number	Description	Color	Dimensions
MOLLE	37CL54BK	STRIKE Flashbang Pouch	Black	4.5"H x 2.5"W x 2.25"D
	37CL54CT	STRIKE Flashbang Pouch	Coyote Tan	4.5"H x 2.5"W x 2.25"D
	37CL54MC	STRIKE Flashbang Pouch	MultiCam	4.5"H x 2.5"W x 2.25"D
	37CL54OD	STRIKE Flashbang Pouch	Olive Drab	4.5"H x 2.5"W x 2.25"D



UTILITY POUCHES

**SMALL UTILITY POUCH**

	Part Number	Description	Color	Dimensions
MOLLE	37CL45BK	STRIKE Small Utility	Black	4" H x 5.5" W x 1.5"D
	37CL45CT	STRIKE Small Utility	Coyote Tan	4" H x 5.5" W x 1.5"D
	37CL45MC	STRIKE Small Utility	Multi Cam	4" H x 5.5" W x 1.5"D
	37CL45OD	STRIKE Small Utility	Olive Drab	4" H x 5.5" W x 1.5"D



**MEDIUM UTILITY POUCH**

	Part Number	Description	Color	Dimensions
MOLLE	37CL46BK	STRIKE Medium Utility Pouch	Black	4.5"H x 7"W x 2"D
	37CL46CT	STRIKE Medium Utility Pouch	Coyote Tan	4.5"H x 7"W x 2"D
	37CL46MC	STRIKE Medium Utility Pouch	Multi Cam	4.5"H x 7"W x 2"D
	37CL46OD	STRIKE Medium Utility Pouch	Olive Drab	4.5"H x 7"W x 2"D



**LARGE UTILITY POUCH WITH ZIPPER**

	Part Number	Description	Color	Dimensions
MOLLE	37CL60BK	STRIKE Large utility w/Zipper	Black	8"H x 7"W x 3"D
	37CL60CT	STRIKE Large utility w/Zipper	Coyote Tan	8"H x 7"W x 3"D
	37CL60MC	STRIKE Large utility w/Zipper	MultiCam	8"H x 7"W x 3"D
	37CL60OD	STRIKE Large utility w/Zipper	Olive Drab	8"H x 7"W x 3"D





## UTILITY POUCH

	Part Number	Description	Color	Dimensions
MOLLE	37CL21BK	STRIKE Utility	Black	5.5"H x 9"W x 3"D
	37CL21CT	STRIKE Utility	Coyote Tan	5.5"H x 9"W x 3"D
	37CL21MC	STRIKE Utility	MultiCam	5.5"H x 9"W x 3"D
	37CL21OD	STRIKE Utility	Olive Drab	5.5"H x 9"W x 3"D



## UPRIGHT GP POUCH

	Part Number	Description	Color	Dimensions
MOLLE	37CL52BK	STRIKE Upright GP	Black	8"H x 5"W x 3"D
	37CL52CT	STRIKE Upright GP	Coyote Tan	8"H x 5"W x 3"D
	37CL52MC	STRIKE Upright GP	MultiCam	8"H x 5"W x 3"D
	37CL52OD	STRIKE Upright GP	Olive Drab	8"H x 5"W x 3"D



## RADIO POUCHES

### SMALL RADIO/GPS POUCH

	Part Number	Description	Color	Dimensions
MOLLE	37CL35BK	STRIKE Small Radio/GPS	Black	4.5-7.5"H x 2.75"W x 1.75"D
	37CL35CT	STRIKE Small Radio/GPS	Coyote Tan	4.5-7.5"H x 2.75"W x 1.75"D
	37CL35MC	STRIKE Small Radio/GPS	MultiCam	4.5-7.5"H x 2.75"W x 1.75"D
	37CL35OD	STRIKE Small Radio/GPS	Olive Drab	4.5-7.5"H x 2.75"W x 1.75"D



### RADIO POUCH MBTR

	Part Number	Description	Color	Dimensions
MOLLE	37CL20BK	STRIKE Radio	Black	6.75-8.75"H x 3.25"W x 1.75"D
	37CL20CT	STRIKE Radio	Coyote Tan	6.75-8.75"H x 3.25"W x 1.75"D
	37CL20MC	STRIKE Radio	MultiCam	6.75-8.75"H x 3.25"W x 1.75"D
	37CL20OD	STRIKE Radio	Olive Drab	6.75-8.75"H x 3.25"W x 1.75"D



### PRC-112 POUCH

	Part Number	Description	Color	Dimensions
MOLLE	37CL26BK	STRIKE Radio PRC-112	Black	7.0-9.0"H x 3.5"W x 2"D
	37CL26CT	STRIKE Radio PRC-112	Coyote Tan	7.0-9.0"H x 3.5"W x 2"D
	37CL26MC	STRIKE Radio PRC-112	MultiCam	7.0-9.0"H x 3.5"W x 2"D
	37CL26OD	STRIKE Radio PRC-112	Olive Drab	7.0-9.0"H x 3.5"W x 2"D



### HYDRATION POUCHES

### NALGENE® BOTTLE UTILITY POUCH

	Part Number	Description	Color	Dimensions
MOLLE	37CL70BK	STRIKE Utility Pouch w/Nalgene Pocket	Black	8"H x 4.5"W x 3"D
	37CL70CT	STRIKE Utility Pouch w/Nalgene Pocket	Coyote Tan	8"H x 4.5"W x 3"D
	37CL70MC	STRIKE Utility Pouch w/Nalgene Pocket	MultiCam	8"H x 4.5"W x 3"D
	37CL70OD	STRIKE Utility Pouch w/Nalgene Pocket	Olive Drab	8"H x 4.5"W x 3"D







### HYDRATION CARRIER

- Accommodates 100-oz hydration reservoir (sold separately)
- S.T.R.I.K.E. webbing for attaching pouches or accessories
- Dimensions: 17”H x 6.5”W x 2.75”D

Part Number	Description	Color
38CL370D	Hydration System Carrier w/Speed Clips 4 x #7	Olive Drab



### HANDCUFF POUCHES

#### CUFF/MAG/LIGHT POUCH

	Part Number	Description	Color
MOLLE	37CL55BK	STRIKE Cuff/Mag/Light	Black
	37CL55CT	STRIKE Cuff/Mag/Light	Coyote Tan
	37CL55MC	STRIKE Cuff/Mag/Light	MultiCam
	37CL55OD	STRIKE Cuff/Mag/Light	Olive Drab



### ADMIN/FLASHLIGHT POUCHES

#### ADMIN/FLASHLIGHT POUCH

- Loop panel and S.T.R.I.K.E.® webbing on front for identification and IR markers
- Large main compartment and smaller compartment with elastic loops for securing items
- Flashlight pocket with adjustable lid fits tactical handheld lights
- Grommets for drainage and attaching lanyards/dummy cords
- Dimensions: 7”H x 7.5”W

Part Number	Description	Color
37CL114BK	Admin/Flashlight Pouch	Black
37CL114CT	Admin/Flashlight Pouch	Coyote Tan
37CL114MC	Admin/Flashlight Pouch	MultiCam
37CL114OD	Admin/Flashlight Pouch	Olive Drab



### ADMIN/COMPASS/FLASHLIGHT POUCH

	Part Number	Description	Color	Dimensions
MOLLE	37CL32BK	STRIKE Admin/Compass/Flash	Black	7.5"H x 7"W
	37CL32CT	STRIKE Admin/Compass/Flash	Coyote Tan	7.5"H x 7"W
	37CL32MC	STRIKE Admin/Compass/Flash	MultiCam	7.5"H x 7"W
	37CL32OD	STRIKE Admin/Compass/Flash	Olive Drab	7.5"H x 7"W



### GLADIUS/ALLY® PLR FLASHLIGHT POUCH

• A pouch designed specifically for the BLACKHAWK!® Gladius and Ally

Part Number	Description	Color
38CL91BK	Gladius/Ally PLR Flashlight Pouch	Black



### MISC. POUCHES

#### BINOCULAR POUCH

- Speed Clip™ 3800 Series attachment
- Smooth protective lining and fully padded throughout
- External zippered storage pocket
- Dimensions: 8"L x 7"W x 3"D

Part Number	Description	Color
60BN02BK	Bino Pouch Large	Black





### FOLDING DUMP POUCH

- Hook & loop attachment
- Belt-mounted folding/roll-up dump pouch
- Low-profile design for use as magazine dump pouch, evidence bag, flex cuff pouch, etc.
- Dimensions: 11”H x 8”W x 5”D

Part Number	Description	Color
37CL77CT	Folding Dump Pouch	Coyote Tan



### S.T.R.I.K.E.® ROLL-UP DUMP POUCH

- Internal elastic loops for light sticks, shotgun shells, etc.
- Shock cord cinches tight to retain contents
- Stiffer in opening of main compartment holds pouch open for easy access
- Grommets for drainage
- S.T.R.I.K.E.® webbing on front for attaching additional items
- Dimensions: 10”H x 8.5”W x 3.75”D

Part Number	Description	Color
37CL117BK	Roll-up Dump Pouch	Black
37CL117CT	Roll-up Dump Pouch	Coyote Tan
37CL117MC	Roll-up Dump Pouch	MultiCam
37CL117OD	Roll-up Dump Pouch	Olive Drab



### COMPASS/STROBE POUCH

Dimensions: 4”H x 3”W x 2.5”D

Part Number	Description	Color
38CL38OD	Compass/Strobe w/Speed Clips 2 x #5	Olive Drab



## MEDICAL POUCHES

### POP-UP TOURNIQUET POUCH

- Quick access to tourniquet (not included)
- Internal 1.5” strap wraps under tourniquet and through lid for easy tourniquet removal
- Dimensions: 4.75”H x 2.25”W x 2.25”D

	Part Number	Description	Color
MOLLE	37CL107BK	Pop-up Tourniquet Pouch	Black
	37CL107CT	Pop-up Tourniquet Pouch	Coyote Tan
	37CL107MC	Pop-up Tourniquet Pouch	MultiCam
	37CL107OD	Pop-up Tourniquet Pouch	Olive Drab



### COMPACT MEDICAL POUCH

- Removable internal panel with multiple loops to organize and retain medical supplies
- Encased foam handle for quick one-handed operation
- Red zipper pulls for medical content identification
- Grommets for drainage
- 2.5" x 2.5" loop panel for patch attachment
- Can be configured for belt wear
- Dimensions: 6.75"H x 4.25"W x 2"D

Part Number	Description	Color
37CL124BK	Compact Medical Pouch	Black
37CL124CT	Compact Medical Pouch	Coyote Tan
37CL124MC	Compact Medical Pouch	MultiCam
37CL124OD	Compact Medical Pouch	Olive Drab



### QUICK RELEASE MED POUCH

- Removable medical pouch disconnects quickly from platform
- Side-release buckle for additional security
- Red handle and zipper pulls for medical content identification
- Grommets for drainage
- Internal pocket and elastic straps for stowing critical supplies
- 2.5" x 2.5" loop on front for patch attachment
- Can be configured for belt wear
- Dimensions: 7"H x 5.5"W x 3"D

Part Number	Description	Color
37CL116BK	Quick Release Medical Pouch	Black
37CL116CT	Quick Release Medical Pouch	Coyote Tan
37CL116MC	Quick Release Medical Pouch	MultiCam
37CL116OD	Quick Release Medical Pouch	Olive Drab



### MEDICAL POUCH

	Part Number	Description	Color	Dimensions
MOLLE	37CL18BK	STRIKE Medical	Black	7.5"H x 5.5"W x 4"D
	37CL18CT	STRIKE Medical	Coyote Tan	7.5"H x 5.5"W x 4"D
	37CL18MC	STRIKE Medical	MultiCam	7.5"H x 5.5"W x 4"D
	37CL18OD	STRIKE Medical	Olive Drab	7.5"H x 5.5"W x 4"D





ACCESSORIES

**SPEED CLIPS™**

- Quickly and efficiently mount and disconnect pouches and other modular gear to any S.T.R.I.K.E.® or PALS/MOLLE platform.
- Eliminate tedious weaving and tested in combat
- Constructed of durable yet flexible polymer
- Designed to mount Speed Clip™ 3800 Series pouches to any S.T.R.I.K.E.® or PALS/MOLLE platform
- Multiple lengths span various widths of webbing to accommodate any size pouch
- # indicates how many widths are spanned



Part Number	Description	Color	MSRP
38C306BK	Speed Clips, six #3s	Black	\$7.45
38C306CT	Speed Clips, six #3s	Coyote Tan	\$7.45
38C306FG	Speed Clips, six #3s	Forest Green	\$7.45
38C306OD	Speed Clips, six #3s	Olive Drab	\$7.45
38C506BK	Speed Clips, six #5s	Black	\$13.45
38C506CT	Speed Clips, six #5s	Coyote Tan	\$13.45
38C706BK	Speed Clips, six #7s	Black	\$13.45
38C706CT	Speed Clips, six #7s	Coyote Tan	\$13.45
38C906BK	Speed Clips, six #9s	Black	\$24.45
38C906CT	Speed Clips, six #9s	Coyote Tan	\$24.45
38C906OD	Speed Clips, six #9s	Olive Drab	\$24.45



**ALICE CLIPS (4 PACK)**

- Authentic military ALICE Clips
- Allows you to attach most BLACKHAWK!® pouches to belt or vest
- Corrosion-resistant for long-lasting performance

Part Number	Description	Color	MSRP
HMAC04	Alice Clip (4 Pack)-Metal	Black	\$7.45



BELT MOUNTED

**Belt Mounted Single Pistol Mag Pouch**

- BTS™ belt loop attachment system
- Constructed of 500 denier ripstop (solid colors) or 1000 denier CORDURA® nylon (MultiCam®)
- Horizontal and vertical 2" belt mount
- Compatible with both single- and double-stacked magazines
- Lid with hook & loop closure

Part Number	Description	Color	MSRP
51PM02BK	Belt Mounted Single Mag	Black	\$15.45
51PM02CT	Belt Mounted Single Mag	Coyote Tan	\$15.45





### BELT MOUNTED DOUBLE PISTOL MAG POUCH WITH TALONFLEX™

- BTS™ belt loop attachment system
- Constructed of ballistic NyTaneon
- TalonFlex™ inserts hold magazine tightly but allow for instant reloads and silent carry
- Holds two pistol magazines
- Flaps can be secured open or closed

Part Number	Description	Color
52PMK2BK	BTS Double Pistol Mag with TalonFlex™	Black



### BELT MOUNTED DOUBLE PISTOL MAG POUCH

- BTS™ belt loop attachment system
- Constructed of 500 denier ripstop (solid colors) or 1000 denier CORDURA® nylon (MultiCam®)
- Horizontal and vertical 2" belt mount
- Compatible with both single- and double-stacked magazines
- Lid with hook & loop closure

Part Number	Description	Color
51PM01BK	Belt Mounted Dbl Mag	Black
51PM01CT	Belt Mounted Dbl Mag	Coyote Tan
51PM01MC	Belt Mounted Dbl Mag	MultiCam
51PM01OD	Belt Mounted Dbl Mag	Olive Drab



### BELT MOUNTED TRIPLE PISTOL MAG POUCH

- BTS™ belt loop attachment system
- TalonFlex™ inserts hold magazine tightly but allow for instant reloads and silent carry
- Holds three pistol magazines
- Flaps can be secured open or closed

Part Number	Description	Color
52PMK3BK	BTS Triple Pistol Mag Pouch w/TalonFlex™	Black





### BELT MOUNTED SINGLE M16 MAG POUCH

- BTS™ belt loop attachment system
- Constructed of 500 denier ripstop
- Fits belts up to 2" wide
- Holds one 30-round M16 magazine
- Lid with hook & loop closure
- Grommets for drainage

Part Number	Description	Color
52DM17BK	Belt Mounted M4 Single Mag	Black
52DM17CT	Belt Mounted M4 Single Mag	Coyote Tan



### BELT MOUNTED 2-OZ. MACE POUCH

- BTS™ belt loop attachment system
- Constructed of 500 denier ripstop
- Fits belts up to 2" wide
- Hook & loop flap to help prevent accidental discharge
- Dimensions: 4"H x 2"W x 1.5"D

Part Number	Description	Color
52DMP2BK	Belt Mounted Mace 2 oz.	Black



### BELT MOUNTED 4-OZ. MACE POUCH

- BTS™ belt loop attachment system
- Constructed of 500 denier ripstop
- Fits belts up to 2" wide
- Hook & loop flap to help prevent accidental discharge
- Dimensions: 6.5"H x 1.5"W x 1.75"D

Part Number	Description	Color
52DMP4BK	Belt Mounted Mace 4 oz	Black



### BELT MOUNTED 12 ROUND SHOTGUN POUCH

- BTS™ belt loop attachment system
- Constructed of 500 denier ripstop
- Holds 12 rounds of 12-gauge ammunition
- Elastic loops inside with hook & loop lid closure for retention
- Fits belts up to 2" wide
- Dimensions: 3.25"L x 7.75"W x 1"D
- Weight: 0.19 lbs.



Part Number	Description	Color
52DS12BK	Belt Mount Shotgun Pouch	Black

### BELT MOUNTED RADIO POUCH

- BTS™ belt loop attachment system
- Constructed of 500 denier ripstop
- Fits belts up to 2" wide
- Fits radios up to 8"L x 2.75"W x 1.5"D
- Hook & loop parachute-cord fastening system



Part Number	Description	Color
52DRP1BK	Belt Mounted Radio	Black

### BELT MOUNTED SINGLE HANDCUFF POUCH

- BTS™ belt loop attachment system
- Constructed of 500 denier ripstop
- Fits belts up to 2" wide
- Lid with hook & loop closure



Part Number	Description	Color
50HC00BK	Single Handcuff	Black
50HC00CT	Single Handcuff	Coyote Tan

### BELT MOUNTED DOUBLE HANDCUFF POUCH

- BTS™ belt loop attachment system
- Constructed of 500 denier ripstop
- Fits belts up to 2.5" wide
- Lid with hook & Loop closure



Part Number	Description	Color
50HC01BK	Double Handcuff	Black



### BELT MOUNTED CROSS DRAW BATON POUCH

- BTS™ belt loop attachment system
- Constructed of 500 denier ripstop
- Designed to be worn in a cross-draw fashion
- Fits 16" – 21" ASP and similar sized batons
- Open-top design for quick baton deployment
- Internal TalonFlex™ ribs for support
- Custom retention strap

Part Number	Description	Color
52CDB1BK	Cross Draw Baton Pouch	Black



### BELT MOUNTED SPEED LOADER POUCH

- BTS™ belt loop attachment system
- Constructed of tough nylon webbing

Part Number	Description	Color
52SL00BK	Belt Mount Speed Loader	Black



## SPORTSTER™ SERIES

### SPORTSTER™ MUZZLE RETAINER

- Constructed of durable 600 denier polyester
- Holds muzzle securely in place
- Includes two #5 Speed Clips™

Part Number	Description	Color
74MR00BK	Sportster Muzzle Retainer	Black



### SPORTSTER™ WEAPON RETAINER (SET OF 2)

- Constructed of durable 600 denier polyester
- Hook & loop closure
- Holds weapon securely in place
- Dimensions: 12"L x 2"W

Part Number	Description	Color
74WR00BK	Sportster Weapon Retainer	Black



### SPORTSTER® UNIVERSAL MAG CASE

- Constructed of durable 600 denier polyester
- Holds most pistol magazines and folding knives
- Fits belts up to 2.25" wide
- Hook & loop flaps for easy adjustment

Part Number	Description	Color
B990232BK	Sportster Single Mag	Black
B990230BK	Sportster Double Mag	Black



B990232BK



B990230BK

**NEW! SPEAR BALCS ARMOR CARRIER - CUTAWAY**

- Remove the carrier in approximately 2.5 seconds and reassemble in less than a minute
- Internal nylon lining for sleek profile and comfortable wear
- Front shoulder panel quick-release strap with rounded handle under protective nylon band
- Heavy-duty drag handle
- Non-slip material on shoulders for weapon retention
- Adjustable waist and shoulder system for tailored girth and torso fit
- Multiple rows of S.T.R.I.K.E.® webbing for attaching pouches, holsters or accessories
- Accommodates BLACKHAWK!® Removable Side Plate Carrier and Ballistic Collar, Yoke, Biceps, Groin and Drop Leg
- Patented release function – US Patent 8,418,265 B1



Part Number	Description	Color	Sizes
32SB40#BK	SPEAR BALCS Armor Carrier - Cutaway	Black	SM-XL
32SB40#CT	SPEAR BALCS Armor Carrier - Cutaway	Coyote Tan	SM-XL
32SB40#MC	SPEAR BALCS Armor Carrier - Cutaway	MultiCam®	SM-XL
32SB40#OD	SPEAR BALCS Armor Carrier - Cutaway	Olive Drab	SM-XL
32SB40#RG	SPEAR BALCS Armor Carrier - Cutaway	Ranger Green	SM-XL
32SB40#UG	SPEAR BALCS Armor Carrier - Cutaway	Urban Gray	SM-XL

# is the size - 1=S, 2=M, 3=L, 4=XL

**NEW! SPEAR BALCS ARMOR CARRIER - NON-CUTAWAY**

- Heavy-duty drag handle
- Non-slip material on shoulders for weapon retention
- Adjustable waist and shoulder system for tailored girth and torso fit
- Multiple rows of S.T.R.I.K.E.® webbing for attaching pouches, holsters or accessories
- Accommodates BLACKHAWK!® Removable Side Plate Carrier and Ballistic Collar, Yoke, Biceps, Groin and Drop Leg



Part Number	Description	Color	Sizes
32SB50#BK	SPEAR BALCS Armor Carrier - Non-Cutaway	Black	SM-XL
32SB50#CT	SPEAR BALCS Armor Carrier - Non-Cutaway	Coyote Tan	SM-XL
32SB50#MC	SPEAR BALCS Armor Carrier - Non-Cutaway	MultiCam®	SM-XL
32SB50#OD	SPEAR BALCS Armor Carrier - Non-Cutaway	Olive Drab	SM-XL
32SB50#RG	SPEAR BALCS Armor Carrier - Non-Cutaway	Ranger Green	SM-XL
32SB50#UG	SPEAR BALCS Armor Carrier - Non-Cutaway	Urban Gray	SM-XL

# is the size - 1=S, 2=M, 3=L, 4=XL





## S.T.R.I.K.E.® CUTAWAY PLATE CARRIER

- Simple construction for quick attachment and detachment (cutaway can be easily disabled)
- Lightest cutaway plate carrier available (only 3.2 lbs.)
- Constructed of 500 denier CORDURA® nylon (MultiCam®) or 500 denier ripstop nylon (solid colors)
- Front shoulder panel quick-release strap with rounded handle under protective nylon band
- Heavy-duty drag handle
- Adjustable waist and shoulder system for tailored girth and torso fit
- Multiple rows of S.T.R.I.K.E.® webbing for attaching pouches, holsters or accessories
- Front plate pocket with inverted “T” elastic keeper accommodates bib when plates are not in use
- Ambidextrous design
- Accommodates BLACKHAWK!® Ballistic Ceramic in fully adjustable front/rear pockets and removable side plate pouches



Part Number	Description	Color
32V701CT	S.T.R.I.K.E. Cutaway Plate Carrier	Coyote Tan

## LOW VIS PLATE CARRIER

- Lightweight, close-fitting design
- Constructed of 500 denier CORDURA® nylon (MultiCam®) or 500 denier ripstop nylon (solid colors)
- Slim enough to be worn under clothes for low visibility
- Adjustable shoulder and side straps (one size fits all)
- Side-release buckles for quick donning and doffing
- Front hook & loop panel for ID patch
- SM/MD version accommodates BLACKHAWK!® Ballistic Ceramic Plates up to 9.5" x 12.5"
- LG/XL version accommodates BLACKHAWK!® Ballistic Ceramic Plates up to 10.5" x 13.25"

Part Number	Description	Size	Color
32PC08BK	Low Vis Plate Carrier	SM/MD	Black
32PC08CT	Low Vis Plate Carrier	SM/MD	Coyote Tan
32PC08MC	Low Vis Plate Carrier	SM/MD	MultiCam®
32PC12BK	Low Vis Plate Carrier	LG/XL	Black
32PC12CT	Low Vis Plate Carrier	LG/XL	Coyote Tan
32PC12OD	Low Vis Plate Carrier	LG/XL	Olive
32PC12MC	Low Vis Plate Carrier	LG/XL	MultiCam®



## REMOVABLE SIDE PLATE CARRIER (PAIR)

- Constructed of 500 denier CORDURA® nylon (COTS MultiCam® and all BAC), or 500 denier ripstop nylon (COTS solid colors)
- Accommodates BLACKHAWK!® Ballistic Ceramic Side Plates up to 6" x 8"
- Attaches to front and rear of PALS/MOLLE platform with side-release buckles
- Removable straps for attachment to S.T.R.I.K.E.® platform with Speed Clips™



### COTS Construction

Part Number	Description	Color
32AC08-CTSBK	Removable Side Plate Carrier (Pair)	Black
32AC08-CTSCT	Removable Side Plate Carrier (Pair)	Coyote Tan
32AC08-CTSOD	Removable Side Plate Carrier (Pair)	Olive Drab
32AC08-CTSMC	Removable Side Plate Carrier (Pair)	MultiCam®



## S.T.R.I.K.E.® COMMANDO RECON CHEST HARNESS

- Cross-back design
- Shoulder straps with closed-cell foam padding
- Heavy-duty D-rings and elastic webbing loops for securing external items
- Multiple rows of S.T.R.I.K.E.® webbing for attaching pouches, holsters or accessories
- Front plate pocket with inverted "T" elastic keeper accommodates bib when plates are not in use
- Accommodates BLACKHAWK!® Ballistic Ceramic Plates up to 10.5" x 13.25"
- Accommodates S.T.R.I.K.E.® Commando Recon Back Panel for full torso rig
- Dimensions (Regular): 24" x 9" (body), 9" x 7" (bib), 69" (girth)
- Weight : 2.1 lbs.

Part Number	Description	Color
37CL01BK	S.T.R.I.K.E.® Commando Recon Chest Harness	Black
37CL01CT	S.T.R.I.K.E.® Commando Recon Chest Harness	Coyote Tan
37CL01MC	S.T.R.I.K.E.® Commando Recon Chest Harness	MultiCam®



## S.T.R.I.K.E.® LIGHTWEIGHT COMMANDO RECON CHEST HARNESS

- Sleek, lightweight design is 40% lighter than S.T.R.I.K.E.® Commando Recon Chest Harness
- Cross-back design
- Constructed of 500 denier CORDURA® nylon (MultiCam®) or 500 denier ripstop nylon (solid colors)
- Shoulder straps with closed-cell foam padding
- Heavy-duty D-rings and elastic webbing loops for securing external items
- Multiple rows of S.T.R.I.K.E.® webbing for attaching pouches, holsters or accessories
- Front plate pocket with inverted “T” elastic keeper accommodates bib when plates are not in use
- Accommodates S.T.R.I.K.E.® Commando Recon Back Panel for full torso rig
- Accommodates BLACKHAWK!® Ballistic Ceramic Plates up to 10.5” x 13.25”
- Dimensions: 23” x 8” (body)
- Weight: 1.52 lbs.



Part Number	Description	Color
37CL82BK	S.T.R.I.K.E.® Lightweight Commando Recon Chest Harness	Black
37CL82CT	S.T.R.I.K.E.® Lightweight Commando Recon Chest Harness	Coyote Tan
37CL82MC	S.T.R.I.K.E.® Lightweight Commando Recon Chest Harness	MultiCam®

## S.T.R.I.K.E.® COMMANDO RECON BACK PANEL

- Heavy-duty drag handle
- IVS™ (Intercooler Venting System) back panel for ventilation
- Large grommeted bottom flap with hook & loop to hold ballistic plates
- Compatible with S.T.R.I.K.E.® Commando Recon Chest Harness for full torso rig
- Accommodates BLACKHAWK!® Ballistic Ceramic Plates up to 10.5” x 13.25”
- Includes shoulder strap
- Weight: 1.45 lbs.

Part Number	Description	Color
37CL41BK	S.T.R.I.K.E.® Commando Recon Back Panel	Black
37CL41CT	S.T.R.I.K.E.® Commando Recon Back Panel	Coyote Tan



## S.T.R.I.K.E.® LIGHTWEIGHT COMMANDO RECON BACK PANEL

- Constructed of 500 denier CORDURA® nylon (MultiCam®) or 500 denier ripstop nylon (solid colors)
- Heavy-duty drag handle
- Dual-adjust side-release buckles for fit adjustment
- Multiple rows of S.T.R.I.K.E.® webbing for attaching pouches, holsters or accessories
- Compatible with S.T.R.I.K.E.® Commando Recon Chest Harness or S.T.R.I.K.E.® Enhanced Commando Recon for full torso rig
- SM/MD version accommodates BLACKHAWK!® Ballistic Ceramic Plates up to 9.5" x 12.5"
- LG/XL version accommodates BLACKHAWK!® Ballistic Ceramic Plates up to 10.5" x 13.25" (sold separately)
- Weight (SM/MD): 12 oz. (LG/XL): 14 oz.



Part Number	Description	Size	Color
37CL85BK	S.T.R.I.K.E.® Lightweight Commando Recon Back Panel	SM/MD	Black
37CL85CT	S.T.R.I.K.E.® Lightweight Commando Recon Back Panel	SM/MD	Coyote Tan
37CL85MC	S.T.R.I.K.E.® Lightweight Commando Recon Back Panel	SM/MD	MultiCam®
37CL86BK	S.T.R.I.K.E.® Lightweight Commando Recon Back Panel	LG/XL	Black
37CL86CT	S.T.R.I.K.E.® Lightweight Commando Recon Back Panel	LG/XL	Coyote Tan
37CL86MC	S.T.R.I.K.E.® Lightweight Commando Recon Back Panel	LG/XL	MultiCam®

## S.T.R.I.K.E.® ENHANCED COMMANDO RECON HARNESS

- Zipper on top edge of cummerbund for internal storage
- Multiple rows of internal/external S.T.R.I.K.E.® webbing for attaching pouches, holsters or accessories
- Magazine pockets on front with quick-release tabs and dividers for up to eight M16/M4 magazines
- Plate pockets with inverted "T" elastic keepers
- Accommodates BLACKHAWK!® Ballistic Ceramic Plates up to 10.5" x 13.25"

Part Number	Description	Color
37CL78BK	S.T.R.I.K.E.® Enhanced Commando Recon Harness	Black
37CL78CT	S.T.R.I.K.E.® Enhanced Commando Recon Harness	Coyote Tan
37CL78OD	S.T.R.I.K.E.® Enhanced Commando Recon Harness	Olive
37CL78MC	S.T.R.I.K.E.® Enhanced Commando Recon Harness	MultiCam®







## S.T.R.I.K.E.® PLATE CARRIER HARNESS

- Heavy-duty drag handle
- IVS™ (Intercooler Venting System) back panel for ventilation
- Large hook & loop flap on front and back to hold ballistic plates
- Multiple rows of S.T.R.I.K.E.® webbing for attaching pouches, holsters or accessories
- Accommodates BLACKHAWK!® Ballistic Ceramic Plates up to 10.5" x 13.25"
- Dimensions: 14"W x 13"H (front), 14"W x 16"H (back)
- Weight: 2.1 lbs.



Front



Back

Part Number	Description	Color
37CL33BK	S.T.R.I.K.E.® Plate Carrier Harness	Black
37CL33CT	S.T.R.I.K.E.® Plate Carrier Harness	Coyote Tan
37CL33MC	S.T.R.I.K.E.® Plate Carrier Harness	MultiCam®

## S.T.R.I.K.E.® LIGHTWEIGHT PLATE CARRIER HARNESS

- Constructed of 500 denier CORDURA® nylon (MultiCam®) or 500 denier ripstop nylon (solid colors)
- Multiple rows of S.T.R.I.K.E.® webbing for attaching pouches, holsters or accessories
- Heavy-duty drag handle
- Dual-adjust side-release buckles for fit adjustment
- SM/MD version accommodates BLACKHAWK!® Ballistic Ceramic Plates up to 9.5" x 12.5
- LG/XL version accommodates BLACKHAWK!® Ballistic Ceramic Plates up to 10.5" x 13.25"
- Weight (SM/MD): 1.3 lbs.
- Weight (LG/XL): 1.5 lbs.



Front



Back

Part Number	Description	Color	Size
37CL83BK	S.T.R.I.K.E.® Lightweight Plate Carrier Harness	Black	SM/MD
37CL83CT	S.T.R.I.K.E.® Lightweight Plate Carrier Harness	Coyote Tan	SM/MD
37CL83MC	S.T.R.I.K.E.® Lightweight Plate Carrier Harness	MultiCam®	SM/MD
37CL84BK	S.T.R.I.K.E.® Lightweight Plate Carrier Harness	Black	LG/XL
37CL84CT	S.T.R.I.K.E.® Lightweight Plate Carrier Harness	Coyote Tan	LG/XL
37CL84MC	S.T.R.I.K.E.® Lightweight Plate Carrier Harness	MultiCam®	LG/XL



## MODULAR DROP-LEG PLATFORM

- Constructed of high-density polymer for comfort and flexibility
- Y-harness configuration with heavy-duty hanger straps and quick-release buckles
- Dual non-slip BTS™ belt loops
- Removable 1.5" non-slip upper leg strap and 2" non-slip lower leg strap for maximum stability
- Ventilated for increased airflow
- Four adjustable accessory rails hold four pouches, mag/light carriers or duty gear accessories

Part Number	Description	Color
432300PBK	Modular Drop-Leg Platform	Black
432300PCT	Modular Drop-Leg Platform	Coyote Tan
432300POD	Modular Drop-Leg Platform	Olive Drab
432300PFG	Modular Drop-Leg Platform	Foliage Green



## DUTY ACCESSORY MOUNTING SCREW KIT

- Required for mounting BLACKHAWK!® duty gear accessories onto Modular Drop-Leg or SERPA® Tactical Holster Platform

Part Number	Description
44AK0001	Duty Accessory Mounting Screw Kit



## S.T.R.I.K.E.® COMPACT DROP-LEG PLATFORM

- Constructed of 500 denier nylon
- Modular drop-leg platform with reduced footprint
- 1.5" wide elastic rubberized leg strap for stability and comfort
- Y-harness configuration and heavy-duty hanger straps with quick-detach swivel buckles
- Tapered, foam-padded platform
- Three rows of S.T.R.I.K.E.® webbing for attaching pouches or accessories
- Dimensions: 5.5"H x 9"W

Part Number	Description	Color
37CL125BK	S.T.R.I.K.E. Compact Drop-Leg Platform	Black
37CL125CT	S.T.R.I.K.E. Compact Drop-Leg Platform	Coyote Tan
37CL125OD	S.T.R.I.K.E. Compact Drop-Leg Platform	Olive Drab
37CL125MC	S.T.R.I.K.E. Compact Drop-Leg Platform	MultiCam®





## ΩMEGA ELITE® TRIPLE PISTOL/DOUBLE CUFF POUCH

- Constructed of 1000 denier nylon
- IVS™ (Intercooler Venting System) back panel for ventilation
- Fully-adjustable triple pistol mag pouches for tall or short mags
- Cuff pouch holds two sets of standard cuffs
- Divider for quick, silent access
- Triple pistol mag pouches and double cuff pouch

Part Number	Description	Color
56TPDCBK	Omega Elite Triple Pistol/Double Cuff Pouch	Black



## ΩMEGA ELITE® DROP-LEG EXTENDER

- Extends gear below belt by five inches
- Attaches to drop-leg holsters, pouches and rigs

Part Number	Description	Color
56DLE2BK	Omega Elite Drop-Leg Extender	Black



## ΩMEGA ELITE® MODULAR DROP-LEG MEDICAL POUCH

- Constructed of 1000 denier nylon
- IVS™ (Intercooler Venting System) back panel for ventilation
- Drainage grommets in bottom of pouches
- Securely mounts to thigh, belt or vest
- Dimensions: 7.75"H x 6.75"W x 2"D

Part Number	Description	Color
56MP00BK	Omega Elite Modular Drop-Leg Medical Pouch	Black
56MP00OD	Omega Elite Modular Drop-Leg Medical Pouch	Olive Drab



## ΩMEGA ELITE® SMG MAG POUCH

- Constructed of 1000 denier nylon
- IVS™ (Intercooler Venting System) back panel for ventilation
- Drainage grommets in bottom of pouches
- Flaps secured by silent side-release buckles
- Holds three 9mm SMG (56SMG3) magazines or 9mm/40 cal or UMP 45 magazines (56SM40)

Part Number	Description	Color
56SMG3BK	9mm SMG Omega Elite Mag Pouch	Black
56SM40BK	9mm/40 Cal/UMP 45 Omega Elite Mag Pouch	Black



## M16 "Y" THIGH RIG

- Drop-leg configuration holds four M16 magazines
- Constructed of lightweight yet durable 500 denier ripstop
- Two mag pouches on front hold two M16 magazines each
- Y-configuration with heavy-duty hanger straps and quick-detach swivel buckles
- Elastic rubberized leg straps for stability and comfort
- Fully adjustable lid height

Part Number	Description	Color
561604BK	M16 "Y" Thigh Rig	Black



## ΩMEGA ELITE® M16 MAG POUCH

- Constructed of 1000 denier nylon
- IVS™ (Intercooler Venting System) back panel for ventilation
- Drainage grommets in bottom of pouches
- Carries two M16/M4 30-round magazines

Part Number	Description	Color
561601BK	Omega Elite M16 Mag Pouch	Black





### ΩMEGA ELITE® ENHANCED M16 DROP-LEG MAG POUCH

- Constructed of 1000 denier nylon
- IVS™ (Intercooler Venting System) back panel for ventilation
- Drainage grommets in bottom of pouches
- Pouch dividers prevent mag clatter and enhance noise discipline
- Carries four M16/M4 30-round mags

Part Number	Description	Color
561602BK	Omega Elite Enhanced M16 Drop-Leg Mag Pouch	Black



### S.T.R.I.K.E.® DROP-LEG PLATFORM

- Constructed of 1000 denier nylon
- Five rows of S.T.R.I.K.E. webbing for attaching pouches or accessories
- Elastic rubberized leg straps for stability and comfort
- Dimensions: 10"H x 9"W

Part Number	Description	Color
37CL39BK	S.T.R.I.K.E. Drop-Leg Platform	Black
37CL39CT	S.T.R.I.K.E. Drop-Leg Platform	Coyote Tan



**ΩMEGA ELITE® GAS MASK POUCH**

- Constructed of 1000 denier nylon
- IVS™ (Intercooler Venting System) back panel for ventilation
- Drainage grommets in bottom of pouches
- Adjustable, removable shoulder strap
- Heavy-duty drop-leg hanger with BTS™ belt loops
- Side-release buckles and hook & loop closure
- Dimensions: 9.75"H x 6.25"W x 5"D

Part Number	Description	Color
56GM00BK	Omega Elite Gas Mask Pouch	Black

**ULTRALIGHT ΩMEGA ELITE® GAS MASK POUCH**

- Constructed of lightweight 500 denier ripstop nylon
- Adjustable, removable shoulder strap and non-slip leg straps
- Y-harness configuration with heavyduty hanger straps and quick-release swivel buckles
- Side-release buckles and hook & loop closure
- Dual non-slip BTS™ belt loops
- 1/8" padded back
- Dimensions: 11"H x 5" – 7.25"W x 4"D  
Cuff pouch: 4"H x 2.25" – 4.5"W

Part Number	Description	Color
56GM03BK	Ultralight Omega Elite Gas Mask Pouch	Black

**ΩMEGA ELITE® DUMP POUCH**

- Constructed of 1000 denier nylon
- IVS™ (Intercooler Venting System) back panel for ventilation
- Drainage grommets in bottom of pouches
- Designed to carry loose ordinance, empty magazines, evidence or contraband
- High-quality YKK® zippers and top hook & loop flap with heavy-duty elastic for secure carry
- Heavy-duty D-rings for shoulder strap attachment
- 3" x 6" front accessory pouch with side-release buckle and hook & loop closure
- Dimensions: 9"H x 5.75"W x 4.5"D

Part Number	Description	Color
56DP00BK	Omega Elite Dump Pouch	Black
56DP00OD	Omega Elite Dump Pouch	Olive Drab
56DP00DE	Omega Elite Dump Pouch	Desert Tan







## LRAK M240/SAW GUNNER KIT

- Two 100-round 240 pouches (also fits 200-round SAW box)
- Two 200-round 7.62 pouches (also fits 200-round SAW box)
- Two 1-qt. canteen pouches and two pop flare pouches
- One gunner tool pouch, one strobe/compass pouch, one enhanced butt pack and one flashlight pouch
- S.T.R.I.K.E.® webbing on shoulders for attaching pouches or accessories
- Elastic retention strap for fins or slung rifle

Part Number	Description	Color
30HH03BK	LRAK M240/SAW Gunner Kit	Black
30HH03CT	LRAK M240/SAW Gunner Kit	Coyote Tan
30HH03OD	LRAK M240/SAW Gunner Kit	Olive Drab
30HH03MC	LRAK M240/SAW Gunner Kit	MultiCam®



## COMMANDO CHEST HARNESS

- Durable 1000 denier nylon with adjustable, padded cross straps with .25" closed-cell foam
- Adjustable quick-release waist strap
- Four ammo pouches hold two AK-47, three M16 or two M14 magazines each
- Pouch dividers prevent magazine clatter and enhance noise discipline
- Two end utility pouches hold radios, rations, compasses, etc.
- Large internal utility/map pouch with securing flap
- Belt loops secure vest to any web belt

Part Number	Description	Color
55CO00BK	Commando Chest Harness	Black
55CO00OD	Commando Chest Harness	Olive Drab
55CO00DE	Commando Chest Harness	Desert Tan



## CHEST MAGAZINE POUCH

- Constructed of durable, lightweight 500 denier ripstop and Type 4 nylon webbing
- One size fits all with adjustable shoulder and waist straps
- Holds eight rifle magazines and two pistol magazines
- Pouches include grommets for drainage and hook & loop lid closures
- Pistol Magazine Pouches - 6.875"H x 1.875"W x 1.25"D
- Rifle Magazine Pockets - 6.875"H x 3.5"W x 1.5"D
- Dimensions: 55CP04 8.375"H x 17.25"W
- Pistol Magazine Pockets - 4.375"H x 1.875"W x 1.25"D
- Rifle Magazine Pockets - 6.375"H x 3"W x 2.25"D



Part Number	Description	Color
55CP01BK	M16/M4 Chest Magazine Pouch	Black
55CP01DE	M16/M4 Chest Magazine Pouch	Desert Tan
55CP01RG	M16/M4 Chest Magazine Pouch	Ranger Green
55CP01UG	M16/M4 Chest Magazine Pouch	Urban Grey
55CP04CT	AK-47 Chest Magazine Pouch	Coyote Tan

## RIFLE/PISTOL BANDOLEER

- Holds four rifle magazines and two pistol magazines
- Cross-torso/shoulder-carried bandoleer with quick-release buckle for fast removal
- Padded back panel and two belt keepers on back panel secure around belt by snap fasteners
- Two M16/M4 adjustable flap mag pouches with silencing dividers in center
- Pistol mag pouches with adjustable flaps
- D-rings at bottom corners for securing to waist belt
- Dimensions: 6.5"H x 11.5"W

Part Number	Description	Color
55RB01BK	Rifle/Pistol Bandoleer	Black





## RIFLE BANDOLEER

- Holds six M16/M4 magazines
- Perfect for active shooter incident response
- Ambidextrous shoulder rig with non-slip pad
- Stabilizing quick-release waist strap

Part Number	Description	Color
55SOS1BK	Rifle Bandoleer	Black



## PATROL RADIO HARNESS

- Holds radios and other small hardware
- Internal pouch for maps and documents
- Adjustable for all portable radio sizes
- Quick-release buckles and elastic antenna support

Part Number	Description	Color
37PRH1BK	Patrol Radio Harness	Black



## LOAD BEARING SUSPENDERS

- Wraparound belt loop system
- Heavy-duty drag handles and sternum strap
- No metal attachment clips
- Belt not included

Part Number	Description	Color
35LBS1BK	Load Bearing Suspenders	Black
35LBS1OD	Load Bearing Suspenders	Olive Drab



## SPECIAL OPERATIONS H-GEAR SHOULDER HARNESS

- Constructed of dual-layer 1000 denier nylon and .375" closed-cell foam padding
- Fully adjustable and attaches to any belt up to 2.25" wide
- Heavy-duty drag handle

Part Number	Description	Color
35SS00BK	Special Operations H-Gear Shoulder Harness	Black



## VESTS

### CUTAWAY OMEGA™ VEST

- Simple cutaway technology with secure release strap and rounded handle under protective nylon band
- Adjustable for length and girth (up to 6" length and 32" girth)
- Heavy-duty YKK® zipper and side-release buckles for rapid donning and doffing
- Belt loops secure vest to web belt
- Reinforced drag handle for operator evacuation if injured
- S.T.R.I.K.E.® webbing for attaching pouches or accessories
- Constructed of durable nylon mesh for maximum breathability
- Padded non-slip shoulders for fully ambidextrous vest
- Two Large internal zippered accessory pockets on both front panels (8.5"H x 10"W)

Part Number	Description	Color
30CV01BK	Cutaway Omega Vest	Black
30CV01CT	Cutaway Omega Vest	Coyote Tan
30CV01MC	Cutaway Omega Vest	MultiCam®



### S.T.R.I.K.E.® OMEGA™ VEST

- Adjustable for length and girth (up to 6" length and 32" girth)
- Heavy-duty YKK® zipper and side-release buckles for rapid donning and doffing
- Belt loops secure vest to web belt
- Reinforced drag handle for operator evacuation if injured
- S.T.R.I.K.E.® webbing for attaching pouches or accessories
- Constructed of durable nylon mesh for maximum breathability
- Padded non-slip shoulders for fully ambidextrous vest
- Lace-style girth adjustment
- Two Large internal zippered accessory pockets on both front panels (8.5"H x 10"W)
- Shoulder D-rings for accessory attachment

Part Number	Description	Color
37CL36BK	S.T.R.I.K.E. Omega Vest	Black







## S.T.R.I.K.E.® ELITE VEST

- Adjustable for length and girth (up to 6" length and 32" girth)
- Heavy-duty YKK® zipper and side-release buckles for rapid donning and doffing
- Belt loops secure vest to web belt
- Reinforced drag handle for operator evacuation if injured
- S.T.R.I.K.E.® webbing for attaching pouches or accessories
- Constructed of durable nylon mesh for maximum breathability
- Padded non-slip shoulders for fully ambidextrous vest
- Side-release buckle and web-style girth adjustment
- Shoulder D-rings for accessory attachment
- Two Large internal zippered accessory pockets on both front panels (8.5"H x 10"W)

Part Number	Description	Color
37CL66BK	S.T.R.I.K.E. Elite Vest	Black
37CL66CT	S.T.R.I.K.E. Elite Vest	Coyote Tan



## OMEGA ELITE™ TACTICAL VEST #1

- Adjustable for length and girth (up to 6" length and 32" girth)
- Heavy-duty YKK® zipper and side-release buckles for rapid donning and doffing
- Belt loops secure vest to web belt
- Reinforced drag handle for operator evacuation if injured
- S.T.R.I.K.E.® webbing for attaching pouches or accessories
- Constructed of durable nylon mesh for maximum breathability
- Padded non-slip shoulders for fully ambidextrous vest
- Two Large internal zippered accessory pockets on both front panels (8.5"H x 10"W)
- Mag pouches with adjustable flaps for tall or short magazines
- Two horizontal accessory pouches
- Six M16/M4 mag pouches hold 12 magazines total

Part Number	Description	Color
30EV03BK	Omega Elite Tactical Vest 1	Black
30EV03DE	Omega Elite Tactical Vest 1	Desert Tan



## OMEGA™ TACTICAL VEST MEDIC/UTILITY

- Adjustable for length and girth (up to 6" length and 32" girth)
- Heavy-duty YKK® zipper and side-release buckles for rapid donning and doffing
- Belt loops secure vest to web belt
- Reinforced drag handle for operator evacuation if injured
- S.T.R.I.K.E.® webbing for attaching pouches or accessories
- Constructed of durable nylon mesh for maximum breathability
- Padded non-slip shoulders for fully ambidextrous vest
- Two Large internal zippered accessory pockets on both front panels (8.5"H x 10"W)
- Eight utility pouches for medical supplies and gear

Part Number	Description	Color
30EV08BK	Omega Tactical Vest Medic/Utility Black	





### OMEGA ELITE™ TACTICAL VEST EOD

- Adjustable for length and girth (up to 6" length and 32" girth)
- Heavy-duty YKK® zipper and side-release buckles for rapid donning and doffing
- Belt loops secure vest to web belt
- Reinforced drag handle for operator evacuation if injured
- S.T.R.I.K.E.® webbing for attaching pouches or accessories
- Constructed of durable nylon mesh for maximum breathability
- Padded non-slip shoulders for fully ambidextrous vest
- Shoulder D-rings for accessory attachment
- Two Large internal zippered accessory pockets on both front panels (8.5"H x 10"W)
- Mag pouches with adjustable flaps for tall or short magazines
- Three M16/M4 mag pouches hold six magazines total
- Pistol mag/flashlight pouch
- Includes removable shotshell strip

Part Number	Description	Color
30EV05BK	Omega Elite Tactical Vest EOD	Black



### OMEGA™ TAC SHOTGUN/RIFLE VEST

- Adjustable for length and girth (up to 6" length and 32" girth)
- Heavy-duty YKK® zipper and side-release buckles for rapid donning and doffing
- Belt loops secure vest to web belt
- Reinforced drag handle for operator evacuation if injured
- S.T.R.I.K.E.® webbing for attaching pouches or accessories
- Constructed of durable nylon mesh for maximum breathability
- Padded non-slip shoulders for fully ambidextrous vest
- Two Large internal zippered accessory pockets on both front panels (8.5"H x 10"W)
- Mag pouches with adjustable flaps for tall or short magazines
- Three M16/M4 pouches hold six magazines total • Holds 28 shotshells in two pouches

Part Number	Description	Color
30EV31BK	Omega Tac Shotgun/Rifle Vest	Black





## OMEGA™ PHALANX HOMELAND SECURITY VEST

- Adjustable for length and girth (up to 6" length and 32" girth)
- Heavy-duty YKK® zipper and side-release buckles for rapid donning and doffing
- Belt loops secure vest to web belt
- Reinforced drag handle for operator evacuation if injured
- S.T.R.I.K.E.® webbing for attaching pouches or accessories
- Constructed of durable nylon mesh for maximum breathability
- Padded non-slip shoulders for fully ambidextrous vest
- Two Large internal zippered accessory pockets on both front panels (8.5"H x 10"W)
- Two M16/M4 pouches hold four magazines total (one has a securing cord for radio)
- Mag pouches with adjustable flaps for tall or short magazines
- Pouches for flashbangs, handcuffs, O.C. spray and tactical light
- 14-round shotshell pouch • Includes removable shotshell strip

Part Number	Description	Color
30EV35BK	Omega Phalanx Homeland Security Vest	Black
30EV35CT	Omega Phalanx Homeland Security Vest	Coyote Tan



## OMEGA ELITE™ CROSS DRAW/PISTOL MAG VEST

- Adjustable for length and girth (up to 6" length and 32" girth)
- Heavy-duty YKK® zipper and side-release buckles for rapid donning and doffing
- Belt loops secure vest to web belt
- Reinforced drag handle for operator evacuation if injured
- S.T.R.I.K.E.® webbing for attaching pouches or accessories
- Constructed of durable nylon mesh for maximum breathability
- Padded non-slip shoulders for fully ambidextrous vest
- Two Large internal zippered accessory pockets on both front panels (8.5"H x 10"W)
- Hook and loop strip for I.D.
- Cross-draw holster secured by adjustable side-release buckle
- Mag pouches with adjustable flaps for tall or short magazines
- Three M16/M4 pouches hold six magazines total
- Four pistol magazine pouches and one horizontal accessory pouch

Part Number	Description	Color
30EV26BK	Omega Elite Cross Draw/Pistol Mag Vest	Black
30EV26BK-Left	Omega Elite Cross Draw/Pistol Mag Vest	Black
30EV26DE	Omega Elite Cross Draw/Pistol Mag Vest	Desert Tan
30EV26DE-Left	Omega Elite Cross Draw/Pistol Mag Vest	Desert Tan
30EV26OD	Omega Elite Cross Draw/Pistol Mag Vest	Olive Drab



## OMEGA ELITE™ OPERATOR VEST – 40MM/RIFLE

- Adjustable for length and girth (up to 6" length and 32" girth)
- Heavy-duty YKK® zipper and side-release buckles for rapid donning and doffing
- Belt loops secure vest to web belt
- Reinforced drag handle for operator evacuation if injured
- S.T.R.I.K.E.® webbing for attaching pouches or accessories
- Constructed of durable nylon mesh for maximum breathability
- Padded non-slip shoulders for fully ambidextrous vest
- Two Large internal zippered accessory pockets on both front panels (8.5"H x 10"W)
- Mag pouches with adjustable flaps for tall or short magazines
- Three M16/M4 pouches hold six magazines total
- One horizontal accessory pouch with hook & loop strip for ID patch
- Eight 40mm pouches

Part Number	Description	Color
30EV290D	Omega Elite Operator Vest 40mm/Rifle	Olive Drab
30EV29CT	Omega Elite Operator Vest 40mm/Rifle	Coyote Tan



## D.O.A.V. ASSAULT VEST SYSTEM

- Adjustable for length and girth (up to 6" length and 32" girth)
- Heavy-duty YKK® zipper and side-release buckles for rapid donning and doffing
- Belt loops secure vest to web belt
- Reinforced drag handle for operator evacuation if injured
- S.T.R.I.K.E.® webbing for attaching pouches or accessories
- Constructed of durable nylon mesh for maximum breathability
- Padded non-slip shoulders for fully ambidextrous vest
- Shoulder D-rings for accessory attachment
- Two Large internal zippered accessory pockets on both front panels (8.5"H x 10"W)
- Four M16/M4 pouches with internal securing straps and dividers hold three magazines each
- Three utility/flashbang pouches and five internal elastic keepers for pens, chem-lights, etc.
- Side light/utility/flashbang pouch and two large daypacks on back for gear, helmets, radio, etc.

Part Number	Description	Color
30DV00BK	D.O.A.V. Assault Vest System	Black





## URBAN ASSAULT VEST

- Adjustable for length and girth (up to 6" length and 32" girth)
- Heavy-duty YKK® zipper and side-release buckles for rapid donning and doffing
- Belt loops secure vest to web belt
- Reinforced drag handle for operator evacuation if injured
- Constructed of durable nylon mesh for maximum breathability
- Padded non-slip sniper shoulders for fully ambidextrous vest
- Shoulder D-rings for accessory attachment
- Two Large internal zippered accessory pockets on both front panels (8.5"H x 10"W)
- Mag pouches with adjustable flaps for tall or short magazines
- Radio pouch with cover flap and wire routing
- Four M16/M4 pouches hold eight magazines total
- Hook & loop strips on front and back for ID patch

Part Number	Description	Color
33UA00BK	Urban Assault Vest	Black



UTILITY/TACTICAL GLOVES

**NEW! F.U.R.Y.® UTILITARIAN GLOVE**

- Touch screen compatible for cell phones
- Silicone grip print on palm for dexterity
- Breathable perforated palm for cooling



Part Number	Description	Color	Size
GT001BK	FURY UTILITARIAN Glove	Black	SM-2XL
GT001TN	FURY UTILITARIAN Glove	Coyote 499	SM-2XL
GT001UG	FURY UTILITARIAN Glove	Urban Gray	SM-2XL

\*To determine the Part #: The 1st 5 digits are the style # (GT001) followed by the 2-digit color code (BK) and then followed by the size code or see a sales rep for a complete listing of style numbers. Example: GT001BKSM



**NEW! F.U.R.Y.® PRIME GLOVE**

- Touch screen compatible for cell phones
- Silicone grip print on palm for dexterity
- Sonic-welded, molded TPR protects back of hand



Part Number	Description	Color	Size
GT002BK	FURY PRIME Glove	Black	SM-2XL
GT002TN	FURY PRIME Glove	Coyote 499	SM-2XL
GT002BK	FURY PRIME Glove	Urban Gray	SM-2XL

\*To determine the Part #: The 1st 5 digits are the style # (GT002) followed by the 2-digit color code (BK) and then followed by the size code or see a sales rep for a complete listing of style numbers. Example: GT002BKSM



**NEW! S.O.L.A.G.® STEALTH GLOVE**

- Touch screen compatible for cell phones
- D30® impact foam protects knuckles
- NOMEX and KEVLAR protects hand from flash, flame and cuts



Part Number	Description	Color	Size
GT008BK	SOLAG STEALTH Glove	Black	SM-2XL

\*To determine the Part #: The 1st 5 digits are the style # (GT008) followed by the 2-digit color code (BK) and then followed by the size code or see a sales rep for a complete listing of style numbers. Example: GT008BKSM







**NEW! S.O.L.A.G.® INSTINCT HALF GLOVE**

- Half fingers for smooth/no catch finger grip
- D30® impact foam protects knuckles
- Silicone grip print on palm for dexterity



Black



Part Number	Description	Color	Size
GT005BK	SOLAG INSTINCT HALF Glove	Black	SM-2XL

\*To determine the Part #: The 1st 5 digits are the style # (GT005) followed by the 2-digit color code (BK) and then followed by the size code or see a sales rep for a complete listing of style numbers. Example: GT005BKSM

**NEW! S.O.L.A.G.® INSTINCT FULL GLOVE**

- Touch screen compatible for cell phones
- D30® impact foam protects knuckles
- Silicone grip print on palm for dexterity



Black



Part Number	Description	Color	Size
GT006BK	SOLAG INSTINCT FULL Glove	Black	SM-2XL

\*To determine the Part #: The 1st 5 digits are the style # (GT006) followed by the 2-digit color code (BK) and then followed by the size code or see a sales rep for a complete listing of style numbers. Example: GT006BKSM

**NEW! S.O.L.A.G.® RECON GLOVE**

- Touch screen compatible for cell phones
- Silicone grip print on palm for dexterity
- Breathable perforated palm for cooling



Black



Coyote 499



Part Number	Description	Color	Size
GT007BK	SOLAG RECON Glove	Black	SM-2XL
GT007TN	SOLAG RECON Glove	Coyote 499	SM-2XL

\*To determine the Part #: The 1st 5 digits are the style # (GT007) followed by the 2-digit color code (BK) and then followed by the size code or see a sales rep for a complete listing of style numbers. Example: GT007BKSM

PATROL GLOVES

**NEW! P.A.T.R.O.L.® ELITE GLOVE**

- Touch screen compatible for cell phones
- Embossed grip print on palm for dexterity
- Watch-compatible cuff for less bulk and easy read

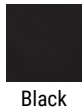

Part Number	Description	Color	Size
GP002BK	PATROL ELITE Glove	Black	SM-2XL

\*To determine the Part #: The 1st 5 digits are the style # (GP002) followed by the 2-digit color code (BK) and then followed by the size code or see a sales rep for a complete listing of style numbers. Example: GP002BKSM

**NEW! P.A.T.R.O.L.® BARRICADE GLOVE**

- Touch screen compatible for cell phones
- KEVLAR construction resists cuts
- Compression-molded neoprene protects knuckles

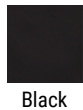

Part Number	Description	Color	Size
GP001BK	PATROL BARRICADE Glove	Black	SM-2XL

\*To determine the Part #: The 1st 5 digits are the style # (GP001) followed by the 2-digit color code (BK) and then followed by the size code or see a sales rep for a complete listing of style numbers. Example: GP001BKSM

SHOOTING GLOVES

**NEW! A.V.I.A.T.O.R.® GLOVE**

- Touch screen compatible for cell phones
- NOMEX construction resists flash and flame
- Seamless index finger for “no catch” trigger finger

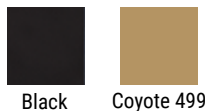

Part Number	Description	Color	Size
GT009BK	AVIATOR Glove	Black	SM-2XL
GT009TN	AVIATOR Glove	Coyote 499	SM-2XL

\*To determine the Part #: The 1st 5 digits are the style # (GT009) followed by the 2-digit color code (BK) and then followed by the size code or see a sales rep for a complete listing of style numbers. Example: GT009BKSM



**NEW! A.V.I.A.T.O.R.® COMMANDO**

- Touch screen compatible for cell phones
- NOMEX construction resists flash and flame
- Seamless index finger for “no catch” trigger finger

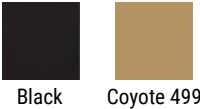

Part Number	Description	Color	Size
GT003BK	AVIATOR COMMANDO Glove	Black	SM-2XL
GT003TN	AVIATOR COMMANDO Glove	Coyote 499	SM-2XL

\*To determine the Part #: The 1st 5 digits are the style # (GT003) followed by the 2-digit color code (BK) and then followed by the size code or see a sales rep for a complete listing of style numbers. Example: GT003BKSM



**NEW! A.V.I.A.T.O.R.® WINTER OPS GLOVE**

- Touch screen compatible for cell phones
- Silicone grip print on palm for dexterity
- Carabiner loop for easy storage/carry

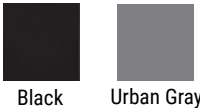

Part Number	Description	Color	Size
GP003BK	AVIATOR WINTER OPS Glove	Black	SM-2XL
GP003UG	AVIATOR WINTER OPS Glove	Urban Gray	SM-2XL

\*To determine the Part #: The 1st 5 digits are the style # (GP003) followed by the 2-digit color code (BK) and then followed by the size code or see a sales rep for a complete listing of style numbers. Example: GP003BKSM



**NEW! A.V.I.A.T.O.R.® APTITUDE GLOVE**

- Insulation keeps cold air out
- Silicone grip print on palm for dexterity
- Fold-back finger tip for smooth, “no catch” trigger finger

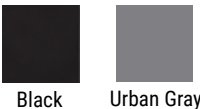

Part Number	Description	Color	Size
GS001BK	AVIATOR APTITUDE Glove	Black	SM-2XL
GS001UG	AVIATOR APTITUDE Glove	Urban Gray	SM-2XL

\*To determine the Part #: The 1st 5 digits are the style # (GS001) followed by the 2-digit color code (BK) and then followed by the size code or see a sales rep for a complete listing of style numbers. Example: GS001BKSM



BALACLAVAS

**POLYPROPYLENE BALACLAVA**

- Combines moisture-wicking properties with internal flat-seam stitching
- Does not provide flash/flame protection

Part Number	Description	Color
333003BK	Polypropylene Balaclava	Black



**FLASH/FLAME-RESISTANT BALACLAVAS WITH NOMEX**

- Heavyweight, Heavyweight Bibbed and Lightweight models
- Constructed of 7.0-oz. NOMEX (Heavyweight and Heavyweight Bibbed) or 6-oz. NOMEX (Lightweight)
- Internal flat-seam stitching prevents irritation when wearing a helmet
- Extended bib protection (Heavyweight Bibbed only)
- Length: 15" (Heavyweight), 18.25" (Heavyweight Bibbed), 18" (Lightweight)

Part Number	Description	Color
333002BK	Heavyweight Balaclava	Black
333002CT	Heavyweight Balaclava	Coyote Tan
333004BK	Heavyweight Bibbed Balaclava	Black
333004CT	Heavyweight Bibbed Balaclava	Coyote Tan
333005BK	Lightweight Balaclava	Black
333005CT	Lightweight Balaclava	Coyote Tan
333005OD	Lightweight Balaclava	Olive Drab
333005FG	Lightweight Balaclava	Foliage Green



Heavyweight Balaclava



Heavyweight Bibbed Balaclava



Lightweight Balaclava

KNEE/ELBOW PADS

**NEOPRENE ELBOW PADS**

- Layered construction and closed-cell foam padding for excellent shock resistance
- Textured outer contact patch for durability and secure grip
- Contoured inner section cradles elbow and prevents slippage and lateral movement
- Easy slip-on design

Part Number	Description	Color
809200BK	Neoprene Elbow Pads	Black





### NEOPRENE KNEE PADS

- Closed-cell foam padding provides excellent shock resistance and little or no moisture retention
- Textured outer contact patch for durability and secure grip
- Internal grip patch and contoured ledge prevent pad slippage
- Dual-secure hook & loop straps keep pad in place

Part Number	Description	Color
809100BK	Neoprene Knee Pads	Black
809100CT	Neoprene Knee Pads	Coyote Tan
809100OD	Neoprene Knee Pads	Olive Drab



### ADVANCED TACTICAL ELBOW PADS V.2

- Closed-cell foam padding provides excellent shock resistance and little or no moisture retention
- 600 denier nylon shell
- Non-slip, flexible, molded polyurethane cap
- Contoured interior ledge prevent pad slippage
- Hook & loop elastic straps keep pad in place

Part Number	Description	Color
802600BK	Advanced Tactical Elbow Pads V.2	Black
802600CY	Advanced Tactical Elbow Pads V.2	Coyote 498
802600OD	Advanced Tactical Elbow Pads V.2	Olive Drab



### ADVANCED TACTICAL KNEE PADS V.2

- Closed-cell foam padding for shock resistance and little or no moisture retention
- Contoured interior ledges prevent pads from slipping downward.
- 600 denier nylon shell
- Injection-molded flex cap design
- Minimizes gap between bottom of cap and nylon carrier when flexed
- Padded side extensions for additional comfort and improved strap positioning
- Hook & loop elastic straps keep pad in place

Part Number	Description	Color
808300BK	Advanced Tactical Knee Pads V.2	Black
808300CY	Advanced Tactical Knee Pads V.2	Coyote 498
808300OD	Advanced Tactical Knee Pads V.2	Olive Drab



### TACTICAL KNEE PADS (PAIR)

Part Number	Description	Color
87KP00CT	Tactical Knee Pads	Coyote Tan





### DYNAMIC ENTRY® SMALL PRY™

- Collaborative effort between BLACKHAWK!®'s Dynamic Entry and Knife design teams
- Combines specialized prying capabilities with a readily available cutting edge
- Ideal for prying interior doors and drawers, window "break and rake" operations and tactical cutting
- Blade length: 4.390"/112mm Overall length: 14.460"/367mm
- Corrosion-resistant black epoxy powder coating on D-2 tool steel blade
- Natural-gas-valve cutoff slot: 1.5"L x .6"W (15DE00YL only)
- S.T.R.I.K.E.® mounting kit (15DE00BK-STRIKE) for attaching to PALS/MOLLE webbing
- **SPECIAL NOTE: This BLACKHAWK! product is restricted to Emergency Response Personnel, Military, Law Enforcement and Security Personnel ONLY**



Part Number	Description	Color
15DE00BK-STRIKE	Small Pry with S.T.R.I.K.E. Mounting Kit	Black



Dynamic Entry® Small Pry Sheath



Backpack Mounting Kit



S.T.R.I.K.E.® Mounting Kit

### DYNAMIC ENTRY® ACTIVE SHOOTER HALLAGAN TOOL

- Features counter-angled friction ridges to grip breaching surfaces securely and increase bite
- Electrically nonconductive handle system is resistant to 100,000 volts AC
- Redesigned tempered stainless steel wedge and horn
- Ergonomic handle reinforces proper hand placement
- Non-sparking fork end
- Length: 24" Weight: 7.5 lbs.
- **SPECIAL NOTE: This BLACKHAWK! product is restricted to Emergency Response Personnel, Military, Law Enforcement and Security Personnel ONLY**



Part Number	Description	Color
DE-ASHT	Active Shooter Hallagan Tool	Black



## DYNAMIC ENTRY® BREAK-N-RAKE™

- Specifically engineered for window entries
  - Electrically nonconductive D-handle system is resistant to 100,000 volts AC
  - Military-grade steel serrated blade and laser-cut hook
  - Three carbon steel 12" raking fins to clear away glass and other debris
  - Reinforced hook removes curtains, blinds and other obstructions
  - Length: 51" (DE-BR), 69" (DE-SBR)
  - Weight: 9.6 lbs. (DE-BR), 11 lbs. (DE-SBR)
- **SPECIAL NOTE: This BLACKHAWK! product is restricted to Emergency Response Personnel, Military, Law Enforcement and Security Personnel ONLY**

Part Number	Description	Color
DE-BR	Break-N-Rake	Black
DE-SBR	Super Break-N-Rake	Black



## DYNAMIC ENTRY® MINI BREAK-N-RAKE™

- Designed in conjunction with domestic and international operators
  - Electrically nonconductive D-handle system is resistant to 100,000 volts AC
  - Can replace Special Operations Hallagan Tool in the Tactical Backpack Kit
  - Easily fits in trunk of patrol or rescue vehicles
  - Length: 25" Weight: 4.5 lbs.
- **SPECIAL NOTE: This BLACKHAWK! product is restricted to Emergency Response Personnel, Military, Law Enforcement and Security Personnel ONLY**

Part Number	Description	Color
DE-MBR	Mini Break-N-Rake	Black

### DYNAMIC ENTRY® BREACHING SLEDGE

- Micro-metal composition for added strength and reduced spalling when struck
- Electrically nonconductive fiberglass handle is resistant to 100,000 volts AC
- Sure-grip handle system reduces the chance of slippage during operations
- Friction ridges on the wedge for added grip and stability during breaching
- Length: 22" Weight: 8 lbs.

**SPECIAL NOTE: This BLACKHAWK! product is restricted to Emergency Response Personnel, Military, Law Enforcement and Security Personnel ONLY**

Part Number	Description	Color
DE-BS	Breaching Sledge	Black



### DYNAMIC ENTRY® BREACHER SERIES

- Electrically nonconductive handle system is resistant to 100,000 volts AC
- Tempered stainless steel wedge with counter-angled friction ridges for tool stability and gripping
- Safety-guard handgrip reduces the possibility of operator's hands slipping onto working end of tool
- Length: 14.25" (Mini Breacher), 24" (Special Ops Breacher), 30" (Standard Breacher)
- Weight: 4.7 lbs. (Mini Breacher), 5.4 lbs. (Special Ops Breacher), 6 lbs. (Standard Breacher)

**SPECIAL NOTE: This BLACKHAWK! product is restricted to Emergency Response Personnel, Military, Law Enforcement and Security Personnel ONLY**

Part Number	Description	Color
DE-MB	Mini Breacher	Black
DE-SOB	Special Operations Breacher	Black
DE-TB	Breacher	Black



### DYNAMIC ENTRY® THUNDERSLEDGE™ SERIES

- Electrically nonconductive handle system is resistant to 100,000 volts AC
- Sure-grip handle system reduces slippage during operations
- Drop-forged, heat-treated carbon steel striking head
- Length: 14" (Micro), 22" (Mini) 32" (ThunderSledge)
- Weight: 4.6 lbs. (Micro), 7.5 lbs. (Mini), 12 lbs. (ThunderSledge)

**SPECIAL NOTE: This BLACKHAWK! product is restricted to Emergency Response Personnel, Military, Law Enforcement and Security Personnel ONLY**

Part Number	Description	Color
DE-MCR	Micro ThunderSledge	Black
DE-MTS	Mini ThunderSledge	Black
DE-TS	ThunderSledge	Black





## DYNAMIC ENTRY® THUNDERMAUL™

- Incorporates an axe and sledge into one compact tool for diverse entry function
- Electrically nonconductive handle system is resistant to 100,000 volts AC
- Sure-grip handle system reduces slippage during operations
- Drop-forged, heat-treated carbon steel striking head
- Nick-resistant tempered blade
- Length: 21.5" Weight: 7.5 lbs.

**SPECIAL NOTE: This BLACKHAWK! product is restricted to Emergency Response Personnel, Military, Law Enforcement and Security Personnel ONLY**

Part Number	Description	Color
DE-TM	ThunderMaul	Black



## DYNAMIC ENTRY® DYNAMIC DUO™ KIT

- Includes Dynamic Entry® Breacher
- Includes Dynamic Entry® ThunderSledge™
- Includes Dynamic Entry® Dynamic Duo Quiver
- Length: 32", Weight: 18 lbs

**SPECIAL NOTE: This BLACKHAWK! product is restricted to Emergency Response Personnel, Military, Law Enforcement and Security Personnel ONLY**

Part Number	Description	Color
DE-DD	Dynamic Duo Kit	Black
DE-DDQ-USA	Dynamic Duo Quiver	Black



## DYNAMIC ENTRY® U.K. HALLAGAN TOOL

- Unique glass-buster head for "break and rake" operations
- Electrically nonconductive handle system is resistant to 100,000 volts AC
- Safety-guard handgrip reduces the possibility of operator's hands slipping onto working end of tool
- Tempered stainless steel wedge with counter-angled friction ridges for stability and slippage prevention
- Wedge: 2" x 4" Length: 32.5" Weight: 7.5 lbs.

**SPECIAL NOTE: This BLACKHAWK! product is restricted to Emergency Response Personnel, Military, Law Enforcement and Security Personnel ONLY**

Part Number	Description	Color
DE-UKHT	U.K. Hallagan Tool	Black



## DYNAMIC ENTRY® NON-SPARKING, ELECTRICALLY NONCONDUCTIVE HALLAGAN TOOL SERIES

- Non-sparking, electrically nonconductive handle system is resistant to 100,000 volts AC
- Ergonomic handle reinforces proper hand placement
- Fork and horn end for prying and breaching
- Use with Dynamic Entry® ThunderSledge™ tools to effectively breach padlocks
- Length: 24" (Special Operations), 29.5" (Standard), 40" (Gorilla Bar)
- Weight: 7.5 lbs. (Special Operations), 8 lbs. (Standard), 17.5 lbs. (Gorilla Bar)

**SPECIAL NOTE:** This BLACKHAWK! product is restricted to Emergency Response Personnel, Military, Law Enforcement and Security Personnel ONLY

**NOTE:** The non-sparking alloy used in these tools is not intended for use on steel doors and frames. If breaching steel doors Dynamic Entry® recommends using one of our stainless steel tools, such as the Stainless HallaganTool™.



Part Number	Description	Color
DE-SOHT	Special Operations Hallagan	Black
DE-HT	Hallagan Tool	Black
DE-GB	Gorilla Bar	Black

## DYNAMIC ENTRY® STAINLESS HALLAGAN TOOL SERIES

- Electrically nonconductive handle system is resistant to 100,000 volts AC
- Safety-guard handgrip reduces the possibility of operator's hands slipping onto working end of tool
- Tempered stainless steel wedge with counter-angled friction ridges for stability and slippage prevention
- Length: 24" (Special Operations), 31" (Stainless Hallagan)
- Weight: 8 lbs. (Special Operations), 8 lbs. (Stainless Hallagan)

**SPECIAL NOTE:** This BLACKHAWK! product is restricted to Emergency Response Personnel, Military, Law Enforcement and Security Personnel ONLY



Part Number	Description	Color
DE-SOSHT	Special Operations Stainless Hallagan Tool	Black
DE-SHTB	Stainless Hallagan Tool	Black

## DYNAMIC ENTRY® CLASSIC HALLAGAN TOOL

- One-piece, drop-forged alloy steel made to exacting standards in the USA
- Forged-in sling attachments
- Includes sling
- Horn: 4.25", Length: 30", Weight: 10 lbs.

**SPECIAL NOTE:** This BLACKHAWK! product is restricted to Emergency Response Personnel, Military, Law Enforcement and Security Personnel ONLY



Part Number	Description	Color
DE-CHT30	Classic Hallagan Tool	Black





### DYNAMIC ENTRY® SPECIAL OPERATIONS ENTRY RAM

- Non-sparking, electrically nonconductive handle system is resistant to 100,000 volts AC
- Ergonomic control-flex handle system reduces impact stress
- Ambidextrous handle orientation for one- or two-person operation
- Forward-weighted design is a close-quarter alternative to the MonoShock Ram™
- Length: 25", Weight: 30 lbs.

**SPECIAL NOTE: This BLACKHAWK! product is restricted to Emergency Response Personnel, Military, Law Enforcement and Security Personnel ONLY**



Part Number	Description	Color
DE-SOER	Special Operations Entry Ram	Black

### DYNAMIC ENTRY® CQB™ RAM

- Non-sparking, electrically nonconductive handle system is resistant to 100,000 volts AC
- Oversized control-flex handle system keeps breachers outside the "fatal funnel" even in cramped areas
- Length: 20", Weight: 23 lbs.

**SPECIAL NOTE: This BLACKHAWK! product is restricted to Emergency Response Personnel, Military, Law Enforcement and Security Personnel ONLY**



Part Number	Description	Color
DE-CQB	CQB Ram	Black

### DYNAMIC ENTRY® MONOSHOCK™ RAM

- Non-sparking, electrically nonconductive handle system is resistant to 100,000 volts AC
- Ergonomic control-flex handle system reduces impact stress
- Includes padded quick-release sling
- Length: 31.5", Weight: 32 lbs.

**SPECIAL NOTE: This BLACKHAWK! product is restricted to Emergency Response Personnel, Military, Law Enforcement and Security Personnel ONLY**



Part Number	Description	Color
DE-MS	MonoShock Ram	Black

### DYNAMIC ENTRY® TWIN TURBO™

- Designed for one- or two-person operation
- Non-sparking, electrically nonconductive handle system is resistant to 100,000 volts AC
- Ergonomic control-flex handle system reduces impact stress
- Includes padded quick-release sling
- Length: 40", Weight: 41.5 lbs.

**SPECIAL NOTE: This BLACKHAWK! product is restricted to Emergency Response Personnel, Military, Law Enforcement and Security Personnel ONLY**



Part Number	Description	Color
DE-TT	Twin Turbo	Black

### DYNAMIC ENTRY® THOR'S HAMMER

- Sure-grip handle system reduces slippage during operations
- Operator-friendly design allows it to be swung outside the “fatal funnel”
- Length: 24”, Weight: 15.4 lbs.

**SPECIAL NOTE: This BLACKHAWK! product is restricted to Emergency Response Personnel, Military, Law Enforcement and Security Personnel ONLY**

Part Number	Description	Color
DE-TH	Thor's Hammer	Black



### DYNAMIC ENTRY® BOLTMASTER™ SERIES

- Heat-treated cutting edges
- Lightweight and durable, each head features a tension adjustment
- Electrically nonconductive fiberglass handle system is resistant to 100,000 volts AC
- Safety-guard handgrip reduces the possibility of operator's hands slipping onto working end of tool
- For use on security chains, chain link fences and non-case-hardened locks
- Jaw opening: 3/8” (BoltMaster), 7/16” (Super)
- Length: 24” (BoltMaster), 30” (Super)
- Weight: 5.75 lbs. (BoltMaster), 8 lbs. (Super)

**SPECIAL NOTE: This BLACKHAWK! product is restricted to Emergency Response Personnel, Military, Law Enforcement and Security Personnel ONLY**

Part Number	Description	Color
DE-MBM	Mini BoltMaster	Black
DE-BM	BoltMaster	Black
DE-SBM	Super BoltMaster	Black



### DYNAMIC ENTRY® BOLTMASTER™ SLING

- Designed to carry the BoltMaster hands-free and at the ready
- Constructed of heavy duty nylon with hook & loop attachment points and a padded shoulder strap

Part Number	Description	Color
DE-BMSL	BoltMaster Sling	Black





### DYNAMIC ENTRY® PADLOCK BUSTER

- Designed for situations where the BoltMaster™ is not recommended
- Electrically nonconductive handle system is resistant to 100,000 volts AC
- Classic duckbill design for use on various padlock sizes
- Constructed of military-grade AR400 steel
- Length: 24.25", Weight: 6.3 lbs.

**SPECIAL NOTE: This BLACKHAWK! product is restricted to Emergency Response Personnel, Military, Law Enforcement and Security Personnel ONLY**



Part Number	Description	Color
DE-PB	Padlock Buster	Black

### DYNAMIC ENTRY® DE 9-11 SERIES RESCUE AXES

- Electrically nonconductive fiberglass handle system is resistant to 100,000 volts AC
- Drop-forged, heat-treated carbon steel heads
- Length: 37"

**SPECIAL NOTE: This BLACKHAWK! product is restricted to Emergency Response Personnel, Military, Law Enforcement and Security Personnel ONLY**



Part Number	Description	Color
DE-AR6P	6-lb. Pike Axe	Red
DE-AR8P	8-lb. Pike Axe	Red
DE-AR6F	6-lb. Flat Axe	Red



### DYNAMIC ENTRY® TACTICAL FENCE CLIMBERS

- Provide a scaling rungs on both sides of the fence for easy and rapid egress
- Lightweight construction
- Folds up for easy storage
- Set of four weighs 5.2 lbs.

**SPECIAL NOTE: This BLACKHAWK! product is restricted to Emergency Response Personnel, Military, Law Enforcement and Security Personnel ONLY**



Part Number	Description	Color
DE-TFC	Tactical Fence Climbers	Black

### DYNAMIC ENTRY™ MANUAL ENTRY TOOL PACK (PACK ONLY)

- Constructed of durable 1000 denier nylon and heavily padded with closed-cell foam
- Retention straps hold tools securely in individual pouches
- Fully adjustable chest and waist straps
- Carries BoltMaster; Special Operations Hallagan Tool or Special Operations Breacher; and ThunderMaul or Mini ThunderSledge

Part Number	Description	Color
60ME00BK	Manual Entry Tool Pack	Black



### DYNAMIC ENTRY™ TACTICAL BACKPACK KIT

- Includes Dynamic Entry® BoltMaster™ (DE-BM)
- Includes Dynamic Entry® ThunderMaul™ (DE-TM)
- Includes Dynamic Entry® Special Operations Hallagan Tool (DE-SOHT)
- Includes Dynamic Entry™ Manual Entry Tool Pack (60ME00BK)

**SPECIAL NOTE: This BLACKHAWK! product is restricted to Emergency Response Personnel, Military, Law Enforcement and Security Personnel ONLY**

Part Number	Description	Color
DE-TBK	Tactical Backpack Kit	Black



### DYNAMIC ENTRY™ U.K. M.O.E.™ TOOL PACK (PACK ONLY)

- Fully adjustable shoulder, waist and under-the-leg straps keep pack anchored to operator's body
- Two large retention flaps

**SPECIAL NOTE: This BLACKHAWK! product is restricted to Emergency Response Personnel, Military, Law Enforcement and Security Personnel ONLY**

Part Number	Description	Color
990662BK	U.K. M.O.E. Tool Pack	Black



### DYNAMIC ENTRY™ U.K. M.O.E.™ BACKPACK KIT

- Designed for Special Forces units worldwide
- Includes Dynamic Entry® Super BoltMaster™ (DE-SBM)
- Includes Dynamic Entry® CQB Ram™ (DE-CQB)
- Includes Dynamic Entry® U.K. Hallagan Tool (DE-UKHT)
- Includes Dynamic Entry™ U.K. M.O.E.™ Tool Pack (990662BK)

**SPECIAL NOTE: This BLACKHAWK! product is restricted to Emergency Response Personnel, Military, Law Enforcement and Security Personnel ONLY**

Part Number	Description	Color
DE- UKMOEK	U.K. M.O.E. Backpack Kit	Black





## DYNAMIC ENTRY™ MODULAR BACKPACK

- Integrates S.T.R.I.K.E. webbing, Speed Clip™ devices and Dynamic Entry Modular Attachment System
- Constructed of durable 1000 denier nylon
- Lumbar padding and wide shoulder straps for maximum comfort
- Large tear-resistant, Kydex®-lined tool pouch with reinforced drain holes
- Modular retention straps for quick and secure mission specific tool configurations
- Includes assortment of various sized modular retention straps

**SPECIAL NOTE: This BLACKHAWK! product is restricted to Emergency Response Personnel, Military, Law Enforcement and Security Personnel ONLY**



Part Number	Description	Color
DE- MBP	Modular Backpack	Black

## DYNAMIC ENTRY™ MINI DEPLOYMENT BAG

- Carries Mini BoltMaster, Mini Breacher and Micro ThunderSledge
- Heavy-duty drag handle
- Shoulder strap with quick-release buckles for ambidextrous carry
- High straps for added stability during extreme body movements
- Internal compartments keep tools secure and reduce noise signature
- Two multipurpose side pockets

Part Number	Description	Color
60ME03BK	Mini Deployment Bag	Black



## DYNAMIC ENTRY® MINI DEPLOYMENT KIT

- Includes Dynamic Entry® Mini Breacher (DE-MB)
- Includes Dynamic Entry® Micro ThunderSledge™ (DE-MCR)
- Includes Dynamic Entry® Mini BoltMaster™ (DE-MBM)
- Includes Dynamic Entry™ Mini Deployment Bag (60ME03BK)

**SPECIAL NOTE: This BLACKHAWK! product is restricted to Emergency Response Personnel, Military, Law Enforcement and Security Personnel ONLY**

Part Number	Description	Color
DE- MDK	Mini Deployment Kit	Black





### DYNAMIC ENTRY® MINI TOOL KIT

- Includes Speed Clips™
- Includes Dynamic Entry® Mini Breacher (DE-MB)
- Includes Dynamic Entry® Micro ThunderSledge™ (DE-MCR)
- Includes Dynamic Entry® Mini BoltMaster™ (DE-MBM)
- Includes two Dynamic Entry® Single Tool Carriers (5100856BK)
- Includes Dynamic Entry® Mini BoltMaster™ Pouch (5100880BK)

**SPECIAL NOTE: This BLACKHAWK! product is restricted to Emergency Response Personnel, Military, Law Enforcement and Security Personnel ONLY**

**Personnel, Military, Law Enforcement and Security Personnel ONLY**



Part Number	Description	Color
DE-MTK	Mini Tool Kit	Black

### DYNAMIC ENTRY® ENTRY KIT #1

- Save 10 percent on MonoShock Ram and Dynamic Duo together
- Includes Dynamic Entry® MonoShock Ram™ (DE-MS)
- Includes Dynamic Entry® Dynamic Duo™ (DE-DD)

**SPECIAL NOTE: This BLACKHAWK! product is restricted to Emergency Response Personnel, Military, Law Enforcement and Security Personnel ONLY**

Part Number	Description	Color
DE-EK1	Entry Kit #1	Black



### DYNAMIC ENTRY® ENTRY KIT #2

- Combines the MonoShock Ram and Break-N-Rake with the Tactical Backpack Kit
- Includes Dynamic Entry® MonoShock Ram™ (DE-MS)
- Includes Dynamic Entry® Break-N-Rake™ (DE-BR)
- Includes Dynamic Entry® Tactical Backpack Kit-B (DE-TBK-B)

**SPECIAL NOTE: This BLACKHAWK! product is restricted to Emergency Response Personnel, Military, Law Enforcement and Security Personnel ONLY**

Part Number	Description	Color
DE-EK2	Entry Kit #2	Black



### DYNAMIC ENTRY™ MINI BOLTMASTER™ POUCH

- Designed to carry Mini BoltMaster
- Webbing on the back allows attachment to MOLLE on vests, carriers and packs.

Part Number	Description	Color
5100880BK	MiniBoltMaster Pouch	Black





### DYNAMIC ENTRY® ENTRY KIT #3

- With this kit, Nothing Shall Stand in Your Way®
- Includes Dynamic Entry® MonoShock Ram™ (DE-MS)
- Includes Dynamic Entry® Dynamic Duo™ (DE-DD)
- Includes Dynamic Entry® Break-N-Rake™ (DE-BR)
- Includes Dynamic Entry® Mobile Home Door Breacher (DE-MHB)
- Includes Dynamic Entry™ Tactical Backpack Kit-B (DE-TBK-B)

**SPECIAL NOTE: This BLACKHAWK! product is restricted to Emergency Response Personnel, Military, Law Enforcement and Security Personnel ONLY**



Part Number	Description	Color
DE-EK3	Entry Kit #3	Black



### SHOTGUN BREACHER'S ACCESSORY KIT

- Weapon's catch, sling and body armor adapter provide an effective and secure retention system
- Weapon's catch attaches to a vest with S.T.R.I.K.E.® webbing using Speed Clips™ or ALICE clip straps
- Sling attaches to the butt of a Knorr® BreachersGrip or similar stock and the armor adapter

Part Number	Description	Color
K02099-B	Breacher's Kit	Black

Single-Point Swivel Sling



Weapon's Catch



(2) ALICE Clips

(2) Speed Clips™



Vest Attachment with D-Ring



### PURPOSE SHIRT

- Tac Flow 2.0 Fabric allows for maximum airflow, with small pinholes in the fabric to keep the wearer cool
- The back features vertical vents with a mesh backing for further breathability
- Three main exterior pockets for storage, as well as a pen pocket
- Plaid fabric reduces printing
- Breakaway snap placket provides quick CCW access when needed
- Convertible sleeves can be rolled up the forearm and held in place with an adjustable tab
- Bartack reinforcement strengthens critical seams

Part Number	Description
CS05XXXX*	Purpose Shirt

\*To determine the Part #: The 1st 4 digits are the style # (CS05) followed by the 2-digit color code (BK) and then followed by the size code (MD) or see a sales rep for a complete listing of style numbers.  
 Example: CS05BKMD  
 SM= small, MD- Medium, LG= Large, XL= X-Large, 2XL= 2 X-Large, 3XL= 3 X-Large

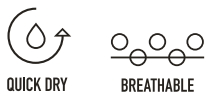

### VERITY SHIRT

- Enzyme garment wash finish for the ultimate softness
- Cotton/poly construction dries quickly
- Printing is mitigated by the plaid pattern
- Breakaway snap placet provides quick concealed-carry access

Part Number	Description
CS06XXXX*	Verity Shirt

\*To determine the Part #: The 1st 4 digits are the style # (CS06) followed by the 2-digit color code (BK) and then followed by the size code (MD) or see a sales rep for a complete listing of style numbers.  
 Example: CS06BKMD  
 SM= small, MD- Medium, LG= Large, XL= X-Large, 2XL= 2 X-Large







### PRECISION SHIRT

- Stretch fabric allows for optimal movement
- Enzyme Garment Wash Finish for the ultimate in softness
- Teflon® Shield+ coating repels stains, oil and water
- Pleats across the back yoke provides extra range of motion for an enhanced fit
- Plaid fabric reduces printing
- Breakaway snap placket provides quick CCW access when needed

Part Number	Description
CS07XXXX*	Precision Shirt

\*To determine the Part #: The 1st 4 digits are the style # (CS07) followed by the 2-digit color code (BK) and then followed by the size code (MD) or see a sales rep for a complete listing of style numbers.  
 Example: CS07BKMD  
 SM= small, MD- Medium, LG= Large, XL= X-Large, 2XL= 2 X-Large, 3XL= 3 X-Large

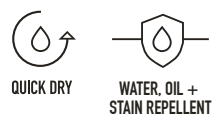

### TAC CONVERTIBLE SHIRT

- High density 100% polyester ripstop fabric
- Light weight texture for comfort and durability
- Teflon® Shield + fabric protector to repel stains, oil and water
- Quick dry
- UPF protection
- Breakaway snap placket
- 2 hidden zippered document pockets
- 2 chest flap pockets with Velcro closure
- Convertible sleeves with button flap
- Vented back panel
- Hidden button down collar
- Double needle stitching at critical seams
- Bartacks at all critical seams



Part Number	Description
TS04XXXX*	Tac Convertible Shirt

\*To determine the Part #: The 1st 4 digits are the style # (TS04) followed by the 2-digit color code (FT) and then followed by the size code (MD) or see a sales rep for a complete listing of style numbers.  
 Example: TS04FTMD  
 SM= small, MD- Medium, LG= Large, XL= X-Large, 2XL= 2 X-Large, 3XL= 3 X-Large, 4XL= 4 X-Large

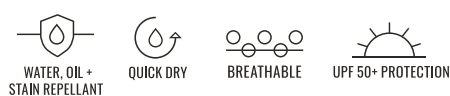

## PURSUIT LONG SLEEVE SHIRT

- 4.0 oz, 65% Polyester/ 35% Cotton blend ripstop
- Textured ripstop with tensile strength and durability
- Teflon® Shield + fabric protector to repel stains, oil and water
- 5 multi-purpose pockets & 2 large hidden chest pockets
- Mic clip at shoulder
- Underarm gusseted panel
- Vented back yoke
- Triple needle reinforcement at all critical seams
- Reinforced elbow patches
- Hidden button down collar

Part Number	Description
TS01XXXX*	Pursuit Long Sleeve Shirt

\*To determine the Part #: The 1st 4 digits are the style # (TS01) followed by the 2-digit color code (SN) and then followed by the size code (MD) or see a sales rep for a complete listing of style numbers. Example: TS01SNMD  
 SM= small, MD- Medium, LG= Large, XL= X-Large, 2XL= 2 X-Large, 3XL= 3 X-Large, 4XL= 4 X-Large



## PURSUIT SHORT SLEEVE SHIRT

- 4.0 oz, 65% Polyester/ 35% Cotton blend ripstop
- Textured ripstop with tensile strength and durability
- Teflon® Shield + fabric protector to repel stains, oil and water
- 5 multi-purpose pockets & 2 large hidden chest pockets
- Mic clip at shoulder
- Underarm gusseted panel
- Vented back yoke
- Triple needle reinforcement at all critical seams
- Bartacks at all critical seams
- Hidden button down collar

Part Number	Description
TS02XXXX*	Pursuit Short Sleeve Shirt

\*To determine the Part #: The 1st 4 digits are the style # (TS02) followed by the 2-digit color code (SE) and then followed by the size code (MD) or see a sales rep for a complete listing of style numbers. Example: TS02SEMD  
 SM= small, MD- Medium, LG= Large, XL= X-Large, 2XL= 2 X-Large, 3XL= 3 X-Large, 4XL= 4 X-Large







### COOL REACT™ POLO

- Cool React™ print inside the polo is sweat-activated to reduce surface temperature by providing a cooling feeling to the skin
- Side vents promote air flow to keep the wearer cool
- No curl collar stays flat for a crisp, clean appearance
- Pocket on the sleeve stores media and other small gear
- Sunglass loop at placket

Part Number	Description
-------------	-------------

PO04XXXX*	Cool React Polo
-----------	-----------------

\*To determine the Part #: The 1st 4 digits are the style # (PO04) followed by the 2-digit color code (SE) and then followed by the size code (MD) or see a sales rep for a complete listing of style numbers. Example: PO02SEMD

SM= Small, MD- Medium, LG= Large, XL= X-Large,  
2XL= 2 X-Large, 3XL= 3 X-Large



### RANGE POLO

- 100% polyester performance double knit pique
- Double sided textured fabric for performance and durability
- Teflon® Shield + fabric protector to repel oil, water and stains
- Mic hook pockets at each shoulder
- Mic clip/sunglass loop at placket
- Vented mesh back
- Media pocket at sleeve with snap closure and cord pass through
- Spandex infused flat knit collar
- Bartacks at all critical seams for added reinforcement

Part Number	Description
-------------	-------------

PO01XXXX*	Range Polo
-----------	------------

\*To determine the Part #: The 1st 4 digits are the style # (PO01) followed by the 2-digit color code (NA) and then followed by the size code (MD) or see a sales rep for a complete listing of style numbers. Example: PO01NAMD

SM= Small, MD- Medium, LG= Large, XL= X-Large,  
2XL= 2 X-Large, 3XL= 3 X-Large, 4XL= 4 X-Large



## CONVOY 1/4 ZIP

- Knit fabric and stretch cover stitching allows for excellent range of motion
- Two-toned heathered fabric with engineered stripe helps to minimize printing of a weapon
- Teflon® Shield+ coating repels oil, water and stains
- Chest and sleeve pockets allow for everyday gear storage
- Media cord opening on the inside of the sleeve pocket keeps headphone cords under the shirt and out of the way

Part Number	Description
CS03XXXX*	Convoy 1/4 Zip Shirt

\*To determine the Part #: The 1st 4 digits are the style # (CS03) followed by the 2-digit color code (SE) and then followed by the size code (MD) or see a sales rep for a complete listing of style numbers. Example: CS03SEMD  
 SM= small, MD- Medium, LG= Large, XL= X-Large,  
 2XL= 2 X-Large, 3XL= 3 X-Large



## BOLSTER JACKET

- Quilted design lines hold advanced lightweight insulation, which significantly improves body heat retention with minimal added bulk
- Exterior treated with Teflon® Shield+ that repels oil, water and stains
- Features 6 multi-function pockets to store a variety of gear
- Zips into the BLACKHAWK!® Fortify Jacket as an inner liner
- Grosgrain loops at sleeves and neck secure the Bolster to the Fortify Jacket
- Industry-leading YKK® zippers are made to the highest standards

Part Number	Description
JK07XXXX*	Bolster Jacket

\*To determine the Part #: The 1st 4 digits are the style # (JK07) followed by the 2-digit color code (AB) and then followed by the size code (MD) or see a sales rep for a complete listing of style numbers. Example: JK07ABMD  
 SM= small, MD- Medium, LG= Large, XL= X-Large,  
 2XL= 2 X-Large, 3XL= 3 X-Large



INTEGRATES WITH FORTIFY JACKET FOR ADDED PROTECTION



## FORTIFY JACKET

- Made from 10,000 MM seam sealed fabric - one of the most waterproof, yet breathable, fabrics available
- A back vent further enhances breathability by encouraging extra airflow with movement
- 4-way stretch construction moves with the wearer ensuring a usable range of motion
- Features 6 multi-function pockets to store a variety of gear, including an interior utility pocket that protects gear from the elements
- Can be worn on its own, or as an exterior shell to the BLACKHAWK!® Bolster Jacket



Part Number	Description
JK06XXXX*	Fortify Jacket

\*To determine the Part #: The 1st 4 digits are the style # (JK06) followed by the 2-digit color code (BK) and then followed by the size code (MD) or see a sales rep for a complete listing of style numbers. Example: JK06BKMD

SM= small, MD- Medium, LG= Large, XL= X-Large, 2XL= 2 X-Large, 3XL= 3 X-Large

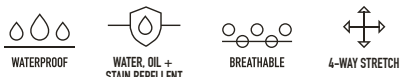

INTEGRATES WITH BOLSTER JACKET FOR ADDED PROTECTION

## DERECHO JACKET

- Constructed from a breathable softshell water-repellant fabric which protects against rain, wind and cold
- Exterior treated with Teflon® Shield+ that repels oil, water and stains
- 4-way stretch construction moves with the wearer ensuring a usable range of motion
- CCW-friendly herringbone pattern resists printing
- A multitude of storage options, including an interior large pocket, interior utility pocket and a hidden key pocket will support your EDC
- Features YKK® metal lux zippers
- Bartack reinforcement strengthens critical seams



Part Number	Description
JK05XXXX*	Derecho Jacket

\*To determine the Part #: The 1st 4 digits are the style # (JK05) followed by the 2-digit color code (SL) and then followed by the size code (MD) or see a sales rep for a complete listing of style numbers. Example: JK05SLMD

SM= small, MD- Medium, LG= Large, XL= X-Large, 2XL= 2 X-Large, 3XL= 3 X-Large



**NEW! EXTREME PURSUIT PANT**

- 4-Way mechanical stretch fabric provides superior range of motion
- Seven multi-purpose pockets include a specialized knife pocket and cargo pockets with AR magazine retention straps
- Action waist band moves and stretches with the wearer
- Silicone grip shirt keeper keeps shirts tucked inside waist band

Part Number	Description
TP06XXXXXX*	Extreme Pursuit Pant

\*To determine the Part #: The 1st 4 digits are the style # (TP06) followed by the 2-digit color code (BK) and then followed by the size code, waist and then inseam (3436) or see a sales rep for a complete listing of style numbers. Example: TP06BK3436

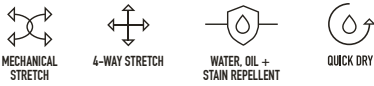

**SHIELD PANT**

- 4-way mechanical stretch rip stop fabric provides superior range of motion
- Teflon® Shield+ protective coating repels stains, oil and water
- Quick dry
- Articulated knees
- Bartacks and rivets at the seams reinforce high stress points
- Strategically placed pockets allow for secure accessory storage

Part Number	Description
TP03XXXXXX*	Shield Pant

\*To determine the Part #: The 1st 4 digits are the style # (TP03) followed by the 2-digit color code (BK) and then followed by the size code, waist and then inseam (3436) or see a sales rep for a complete listing of style numbers. Example: TP03BK3436

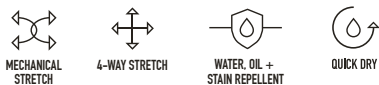





### FORTIFY PANT

- Premium waterproof material - 10,000MM waterproof and seam sealed fabric
- Teflon® Shield+ protective coating repels water, oils and stains
- Brushed soft Tricot fabric-lined waistband
- Adjustable waistband and leg openings
- 4-Way stretch fabric and gusseted crotch
- Two concealed side-seam zippers allow easy access to pants pockets
- Two exterior back pockets
- Knees, hems and critical seams are reinforced for enhanced durability

Part Number	Description
TP04XXXX*	Fortify Pant

\*To determine the Part #: The 1st 4 digits are the style # (TP04) followed by the 2-digit color code (BK) and then followed by the size code (MD) or see a sales rep for a complete listing of style numbers. Example: TP04BKMD

SM= small, MD- Medium, LG= Large, XL= X-Large,

2XL= 2 X-Large, 3XL= 3 X-Large

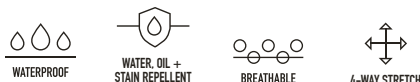

Black (BK)



### DESERT OPS BOOT

- AR 670-1 COMPLIANT - Conforms with updated U.S. Army uniform appearance code
- VIBRAM® OUTSOLE- Features oil-resistant TC4+ construction, with large, open lugs that provide superior traction
- DRI-LEX® INNER LINING- Wicks away moisture to keep feet dry

SKU	Description	Color	Size
BT05CY	Desert Ops Boot	Coyote 498 (CY)	4.5-6.5 M; 7-12 M or W; 13, 14 M or W



### TERRAIN MID BOOT

- BREATHABLE MESH UPPER- Keeps feet cool and dry
- MEMORY FOAM INSOLE- Provides comfort and support
- AGION® ANTIMICROBIAL LINING- Controls, mitigates odor

SKU	Description	Color	Size
MD01BK	Terrain Mid Boot	Black (BK)	7-12 M; 13, 14 M





BELTS



**CQB/RIGGER'S BELT**

- Parachute-grade buckles and adapters meet PIA-H-7195 standards
- 1.75" webbing with 7,000-lb. tensile strength (solid colors) or 5,000-lb. tensile strength (MultiCam®)
- Hook & loop secures running end

Part Number	Description	Color	Size
41CQ00BK	CQB/Rigger's Belt	Black	to 34"
41CQ00OD	CQB/Rigger's Belt	Olive	to 34"
41CQ00DE	CQB/Rigger's Belt	Desert Tan	to 34"
41CQ00DB	CQB/Rigger's Belt	Brown	to 34"
41CQ00MC	CQB/Rigger's Belt	MultiCam®	to 34"
41CQ01BK	CQB/Rigger's Belt	Black	to 41"
41CQ01OD	CQB/Rigger's Belt	Olive	to 41"
41CQ01DE	CQB/Rigger's Belt	Desert Tan	to 41"
41CQ01DB	CQB/Rigger's Belt	Brown	to 41"
41CQ01MC	CQB/Rigger's Belt	MultiCam®	to 41"
41CQ02BK	CQB/Rigger's Belt	Black	41"-51"
41CQ02OD	CQB/Rigger's Belt	Olive	41"-51"
41CQ02DE	CQB/Rigger's Belt	Desert Tan	41"-51"
41CQ02DB	CQB/Rigger's Belt	Brown	41"-51"
41CQ02MC	CQB/Rigger's Belt	MultiCam®	41"-51"



Part Number	Description	Color	Size
41CQ00499	CQB/Rigger's Belt	Army Tan 499	to 34"
41CQ00499	CQB/Rigger's Belt	Army Tan 499	to 41"
41CQ00499	CQB/Rigger's Belt	Army Tan 499	to 51"



## CQB/RIGGER'S BELT WITH COBRA BUCKLE

Part Number	Description	Color	Size
41CQ11BK	Rigger's Belt w/ Cobra Buckle	Black	to 34"
41CQ12BK	Rigger's Belt w/ Cobra Buckle	Black	to 41"
41CQ13BK	Rigger's Belt w/ Cobra Buckle	Black	41"-51"
41CQ11DB	Rigger's Belt w/ Cobra Buckle	Brown	to 34'
41CQ12DB	Rigger's Belt w/ Cobra Buckle	Brown	to 41"
41CQ13DB	Rigger's Belt w/ Cobra Buckle	Brown	41"-51"
41CQ11DE	Rigger's Belt w/ Cobra Buckle	Desert Sand	to 34"
41CQ12DE	Rigger's Belt w/ Cobra Buckle	Desert Sand	to 41"
41CQ13DE	Rigger's Belt w/ Cobra Buckle	Desert Sand	41"-51"
41CQ11OD	Rigger's Belt w/ Cobra Buckle	Olive Drab	to 34'
41CQ12OD	Rigger's Belt w/ Cobra Buckle	Olive Drab	to 41"
41CQ13OD	Rigger's Belt w/ Cobra Buckle	Olive Drab	41"-51"
41CQ11MC	Rigger's Belt w/ Cobra Buckle	Multi-Cam	to 34'
41CQ12MC	Rigger's Belt w/ Cobra Buckle	Multi-Cam	to 41"
41CQ13MC	Rigger's Belt w/ Cobra Buckle	Multi-Cam	41"-51"

### INSTRUCTOR'S GUN BELT – 1.5"

- Polyethylene spine to help bear the weight of belt-mounted holsters and equipment
- Parachute-grade buckles and adapters meet PIA-H-7195 standards
- 1.5" webbing with 7,000-lb. tensile strength (solid colors) or 4,000-lb. tensile strength (MultiCam®)
- Hook & loop secures running end

Part Number	Description	Color	Size
41VT10BK	Instructor's Gun Belt – 1.5"	Black	to 34"
41VT10MC	Instructor's Gun Belt – 1.5"	MultiCam®	to 34"
41VT11BK	Instructor's Gun Belt – 1.5"	Black	to 41"
41VT11MC	Instructor's Gun Belt – 1.5"	MultiCam®	to 41"
41VT12BK	Instructor's Gun Belt – 1.5"	Black	41"-51"
41VT12MC	Instructor's Gun Belt – 1.5"	MultiCam®	41"-51"



### INSTRUCTOR'S GUN BELT – 1.75"

- Polyethylene spine to help bear the weight of belt-mounted holsters and equipment
- Parachute-grade buckles and adapters meet PIA-H-7195 Standards
- 1.75" webbing with 7,000-lb. tensile strength
- Hook & loop secures running end

Part Number	Description	Color	Size
41VT01BK	Instructor's Gun Belt – 1.75"	Black	34"-41"
41VT02BK	Instructor's Gun Belt – 1.75"	Black	42"-42"



### INSTRUCTOR'S BELT WITH COBRA BUCKLE

- Two layers of T13 military-grade web for durability with 7,000lbs of tensile strength
- Reinforced with polymer stiffener for better support of equipment
- Rated Cobra buckle for quick release
- Hook & Loop closure

Part Number	Description	Color	Size
41VT40BK	Instructor's Belt w/Cobra Buckle	Black	to 34"
41VT41BK	Instructor's Belt w/Cobra Buckle	Black	to 41"
41VT42BK	Instructor's Belt w/Cobra Buckle	Black	41"-51"





## UNIVERSAL BDU BELT

- Lightweight 1.75" wide belt with metal friction buckle
- One size fits all (up to 52")

Part Number	Description	Color
41UB01BK	Universal BDU Belt	Black
41UB01OD	Universal BDU Belt	Olive
41UB01DE	Universal BDU Belt	Desert Tan
41UB01DB	Universal BDU Belt	Brown



## MILITARY WEB BELT (MODERNIZED)

- 2.25" wide belt with three point side-release buckle for quick-on/quick-off (no heavy metal hardware)
- Hook & loop size adjustment
- Top choice among the military

Part Number	Description	Color	Size
41WB02BK	Military Web Belt-modernized	Black	L (to 43")
41WB02OD	Military Web Belt-modernized	Olive	L (to 43")
41WB02FG	Military Web Belt-modernized	Green	L (to 43")
41WB02DE	Military Web Belt-modernized	Desert Tan	L (to 43")
41WB03BK	Military Web Belt-modernized	Black	XL (44"-49")
41WB03OD	Military Web Belt-modernized	Olive	XL (44"-49")
41WB03FG	Military Web Belt-modernized	Green	XL (44"-49")
41WB03DE	Military Web Belt-modernized	Desert Tan	XL (44"-49")



## BELT EXTENDER

- Expands girth of Military Web Belt when wearing vest or jacket
- Patented three-point side release buckle

Part Number	Description	Color
41WBE2BK	Belt Extender	Black
41WBE2OD	Belt Extender	Olive



### ENHANCED PATROL BELT PAD

- Closed-cell foam padding will not absorb moisture
- 3-D mesh for comfort and ventilation
- Fits belts up to 2.75" wide
- Two rows of S.T.R.I.K.E.® webbing for attaching pouches or accessories
- Convenient openings help guide belt through pad
- Non-slip lining keeps pad in place
- Accommodates Military Web Belt



Part Number	Description	Color	Size
41PB00CT	Enhanced Patrol Belt Pad	Tan	Small (36")
41PB00MC	Enhanced Patrol Belt Pad	MultiCam®	Small (36")
41PB01CT	Enhanced Patrol Belt Pad	Tan	MD (39.5")
41PB01MC	Enhanced Patrol Belt Pad	MultiCam®	MD (39.5")
41PB02CT	Enhanced Patrol Belt Pad	Tan	L (42.5")
41PB02MC	Enhanced Patrol Belt Pad	MultiCam®	L (42.5")

### BELT PAD WITH IVS™

- Constructed of 1000 denier nylon
- .375" closed-cell foam padding will not absorb moisture or perspiration
- Belt keepers fit belts up to a 2.25" wide



Part Number	Description	Color	Size
41BP00BK	Belt Pad with IVS	Black	S (28"-34")
41BP00OD	Belt Pad with IVS	Olive	S (28"-34")
41BP02BK	Belt Pad with IVS	Black	MD (36"-40")
41BP02OD	Belt Pad with IVS	Olive	MD (36"-40")
41BP03BK	Belt Pad with IVS	Black	L (42"-48")
41BP03OD	Belt Pad with IVS	Olive	L (42"-48")

### S.T.R.I.K.E.® REVERSIBLE MODULAR BELT PANELS

- Allows you to wear PALS/MOLLE-compatible pouches with any belt
- Reversible design supports vertical or horizontal mount
- Various sizes allow for different lengths
- Fits belts up to 2.5" wide

Part Number	Description	Color
41PL12BK	12" Belt Panel	Black
41PL12CT	12" Belt Panel	Tan
41PL12OD	12" Belt Panel	Olive
41PL12FG	12" Belt Panel	Green



Horizontal Mount



Vertical Mount





## PADDED PATROL BELT

- Closed-cell foam will not absorb moisture or perspiration
- S.T.R.I.K.E.® webbing for attaching pouches or accessories
- Secured by 2.25" three point side release buckle and hook / loop tabs

Part Number	Description	Color	Size
41PBT0DE	Padded Patrol Belt w/ IVS	Desert Tan	XS (32.5"- 42")
41PBT1DE	Padded Patrol Belt w/ IVS	Desert Tan	S (37"- 43")
41PBT2DE	Padded Patrol Belt w/ IVS	Desert Tan	M (43"-49")
41PBT3DE	Padded Patrol Belt w/ IVS	Desert Tan	L (46"-52")



## CARTRIDGE BELT

- Durable cam buckle and nylon construction
- Universal cartridge belts fit up to 50" waist

Part Number	Description	Color
74BC00BK	Handgun Cartridge Belt	Black
74BC02BK	Shotgun Cartridge Belt	Black
74BC01BK	Rifle Cartridge Belt	Black



### TRIDENT CAP

- Flexible fabric
- Adjustable Velcro closure
- Six-panel construction
- Stitched vent holes for breathability
- One size fits all



Americana  
(AM)

Thin Blue Line  
(TB)

Part Number	Description
EC07XXXX*	Trident Cap

\*To determine the Part #: The 1st 4 digits are the style # (EC07) followed by the 2-digit color code (AM) followed by the size code (OS) or see a sales rep for a complete listing of style numbers. Example: EC07AMOS

### WEATHERED RIPSTOP CAP

- Stone washed for a soft finish
- Adjustable Velcro closure
- Six-panel construction
- Stitched vent holes for breathability
- AR detail under bill
- One size fits all



Fatigue  
(FT)

Stone  
(SN)

Navy  
(NA)

Part Number	Description
EC06XXXX*	Weathered Ripstop Cap

\*To determine the Part #: The 1st 4 digits are the style # (EC06) followed by the 2-digit color code (FT) followed by the size code (OS) or see a sales rep for a complete listing of style numbers. Example: EC06FTOS

### TACTICAL CAP

- 100% cotton washed chino
- Velcro appliques for patch attachment
- Adjustable Velcro closure
- One size fits all



Black  
(BK)

Stone  
(SN)

Jungle  
(JG)

Part Number	Description
EC01XXXX*	Tactical Cap

\*To determine the Part #: The 1st 4 digits are the style # (EC01) followed by the 2 or 4-digit color code (BK) followed by the size code (OS) or see a sales rep for a complete listing of style numbers. Example: EC01BKOS



### RANGE CAP

- Low profile design goes anywhere
- Breathable moisture-wicking construction dries quickly
- One size fits all

Part Number	Description
PC03XXXX*	Range Cap

\*To determine the Part #: The 1st 4 digits are the style # (PC03) followed by the 2-digit color code (SL) and then followed by the size code (OS) or see a sales rep for a complete listing of style numbers. Example: PC03SLOS



Black/Slate (SL)

### MARLED BEANIE

- Knitted, flexible fabric
- Retains heat
- One size fits all

Part Number	Description
EB02XXXX*	Marled Beanie

\*To determine the Part #: The 1st 4 digits are the style # (EB02) followed by the 2-digit color code (AB) and then followed by the size code (OS) or see a sales rep for a complete listing of style numbers. Example: EB02ABOS



### MICRO FLEECE BEANIE

- 100% polyester
- Mirco fleece shell for warmth
- Moisture wicking mesh lining
- One size fits all

Part Number	Description
EB01XXXX*	Micro Fleece Beanie

\*To determine the Part #: The 1st 4 digits are the style # (EB01) followed by the 2-digit color code (BK) and then followed by the size code (OS) or see a sales rep for a complete listing of style numbers. Example: EB01BKOS



PATCHES

**IDENTIFICATION PANEL BASE**

- Hook & loop panel for attaching ID panels to S.T.R.I.K.E.® webbing
- Mounts with Speed Clips™ (two included)
- Dimensions: 2.5”H x 5.5”W

Part Number	Description	Color
38CL42BK	Identification Panel Base	Black



**RED CROSS MEDIC ID PATCH**

- Smooth embroidery (not printed)
- Hook backing with loop panel included
- Can be sewn to clothing or gear
- Dimensions: 2.5”H x 2.5”W

Part Number	Description	Color
90RC00BK	Red Cross Medic ID Patch	Black



**AMERICAN FLAG PATCH**

- Embroidered with matching border
- Hook & loop panel for quick on/off capability
- Dimensions: 2”H x 3”W

Part Number	Description	Color
90SAFV-R	American Flag Patch-Reversed	Olive Drab
90RWBV-R	American Flag Patch-Reversed	Full Color
90DTFV-R	American Flag Patch-Reversed	Coyote Tan
90SAFV	American Flag Patch	Olive Drab
90RWBV	American Flag Patch	Full Color
90DTFV	American Flag Patch	Coyote Tan



90SAFV-R  
Reversed  
Subdued Olive Drab



90RWBV-R  
Reversed  
Full Color



90DTFV-R  
Reversed  
Subdued Coyote Tan



90SAFV  
Standard  
Subdued Olive Drab



90RWBV  
Standard  
Full Color



90DTFV  
Standard  
Subdued Coyote Tan



## ACCESSORIES

**NEW! BLACKHAWK / CAMELBAK CHUTE MAG TITAN**

The BLACKHAWK!/Camelbak Chute Mag Tritan is a rugged, reliable hydration option that can handle the rigors of everyday use. An integrated magnet holds the cap free from the rapid-flow spout. The leakproof, BPA-free bottle features a comfortable carry handle, and is compatible with the S.T.R.I.K.E. Utility Pouch with Bottle Pocket.

- **EASY TO CLEAN**- All parts are top-rack dishwasher safe.
- **CONVENIENT**- Integrated magnet safely stows cap when not needed.
- **EASY ACCESS**- Wide-mouth opening freely dispenses liquid, accommodates ice cubes or water filtration devices.

Part Number	Description
AC02BK32	CHUTE MAG TITAN 32 oz Water Bottle

**C.I.A. LANYARD**

- Credentials Information Access Lanyard is perfect for CAC cards and other ID
- Two-sided smart-card holder protects up to two access cards
- 5mm Lanyard with detachable 3mm rope end

Part Number	Description	Color
90ID03BK	C.I.A. Lanyard	Black

**ID-BADGE HANGER**

- Lid is secured with hook & loop
- Two slip pockets for passport, ID, business cards, money, etc.
- Pen pouch for quick access

Part Number	Description	Color
90ID01BK	5.3" x 3.8" Badge Hanger	Black









**HONOR. AS A WAY OF LIFE.®**