



ZEISS Hunting Catalogue 2018



ON THE TRAIL OF NATURE IN TWO DIFFERENT FORMS

Anyone who hunts is brought closer to two different forms of nature: the nature of the world around them and the nature that dwells within. Both fuse into one in moments of intense concentration.

Not least thanks to the binoculars and riflescopes from ZEISS – precision instruments, perfectly matched to the specific needs of hunters. Nevertheless, one common factor is shared by them all: typical premium quality from ZEISS.

PRECISELY TAILORED TO YOUR NEEDS

VICTORY



The ultimate: Victory® line hunting optics from ZEISS fulfil the highest personal expectations and hunting needs. In terms of technology, they exhaust the limits of the physically possible. Their concepts and details of their design promise unforgettable moments. An investment for hunters who do not like to compromise.

CONQUEST



Uncompromising in all aspects of design, ergonomics and optical excellence, yet outstanding value for money. Never before has more performance been offered in this price class than with Conquest® riflescopes and binoculars from ZEISS. These perfect all-rounders unite traditional ZEISS quality with state-of-the-art technology. Conquest products offer you entry-level access to the premium class of ZEISS.

TERRA



Experience ZEISS quality in a form reduced to the essentials: simple handling, robust construction and functional design make the binoculars from the Terra® line the perfect entry-level optics for discovering the world of ZEISS. You realise your ambitions; ZEISS provides the tools.



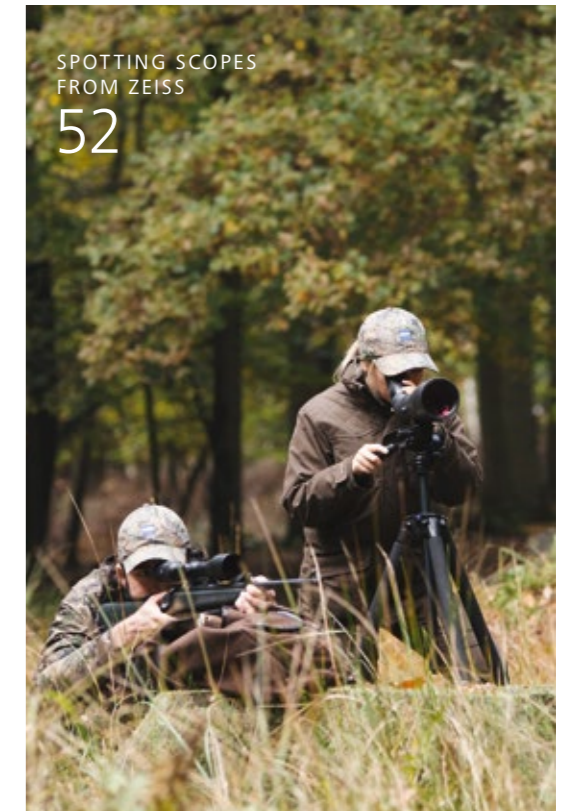
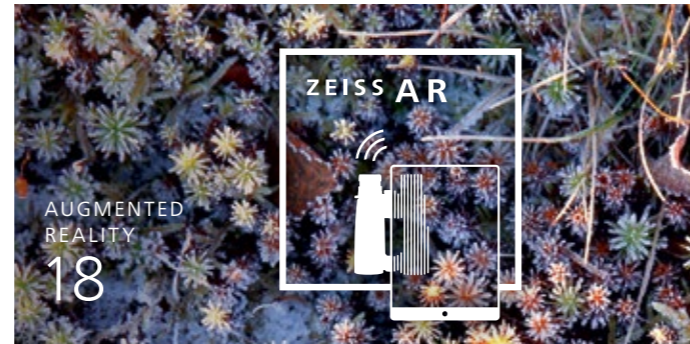

Contents

Riflescopes

Binoculars and spotting scopes

VICTORY

Riflescopes	20	Binoculars	34
V8 riflescopes	24	Rangefinder System	38
HT Riflescopes	27	SF binoculars	40
		HT binoculars	42
		FL binoculars	44
		Pocket binoculars	44
		Spotting scopes	52
		Harpia spotting scopes	56

CONQUEST

V6 riflescopes	28	HD binoculars	46
V4 riflescopes	32	Gavia 85 spotting scope	60

TERRA

		ED binoculars	48
--	--	---------------	----

PANORAMA

Product news	8	Augmented reality	18
Carl Zeiss AG – the company	10		

SPECIALS

Night vision	50	20 × 60	51
Monos	51	Dialyt	62

ACCESSORIES

Accessories for spotting scopes	75	Accessories for binoculars	77
Accessories for riflescopes	76		

TECHNICAL SPECIFICATIONS

Riflescopes	64	Spotting scopes	74
Binoculars	68		

NEWS

ZEISS CONQUEST V4

MADE FOR THE MOST RUGGED HUNTING SITUATIONS

No compromises in quality and robustness: the high-performance riflescopes of the Conquest V4 line unite the proven ZEISS optical concept with robust construction and functional design.



Featuring a 4x zoom range and a ballistic turret, these scopes set a new standard in their class. More information can be found on page 32.

ZEISS VICTORY HARPIA

THE PATHFINDER IN ITS CLASS

Discover the worlds of nature and wildlife in crisp, sharp images with perfect colour rendition, even at extreme ranges. The highlights of the Victory Harpia, the new top-of-the-range spotting scope from ZEISS, include a 3x wide-angle zoom, up to 70x magnification and other features such as Dual Speed Focus for fast and precise focusing. More information can be found on page 56.



ZEISS VICTORY RANGEFINDER SYSTEM



A NEW LEVEL OF SHOOTING ACCURACY

The Victory Rangefinder System is a laser rangefinder with an integrated real-time ballistics computer. The consideration of all relevant factors and customisation with the aid of the ZEISS Hunting App ensure precisely placed shots at any distance. More information can be found on page 38.

THE ZEISS HUNTING APP

THE APP FOR TODAY'S HUNTERS

The versatile hunting companion

The versatile functions of the ZEISS Hunting App have already established it as an invaluable hunting companion. The revised version is compatible with the ZEISS Victory Rangefinder System and allows the transfer of a wide range of data stored in the ballistics computer to the Victory Rangefinder. Thanks to the addition of its information on distance, angle and environmental factors, hunters achieve an entirely new quality of aiming accuracy. More information can be found on page 38.

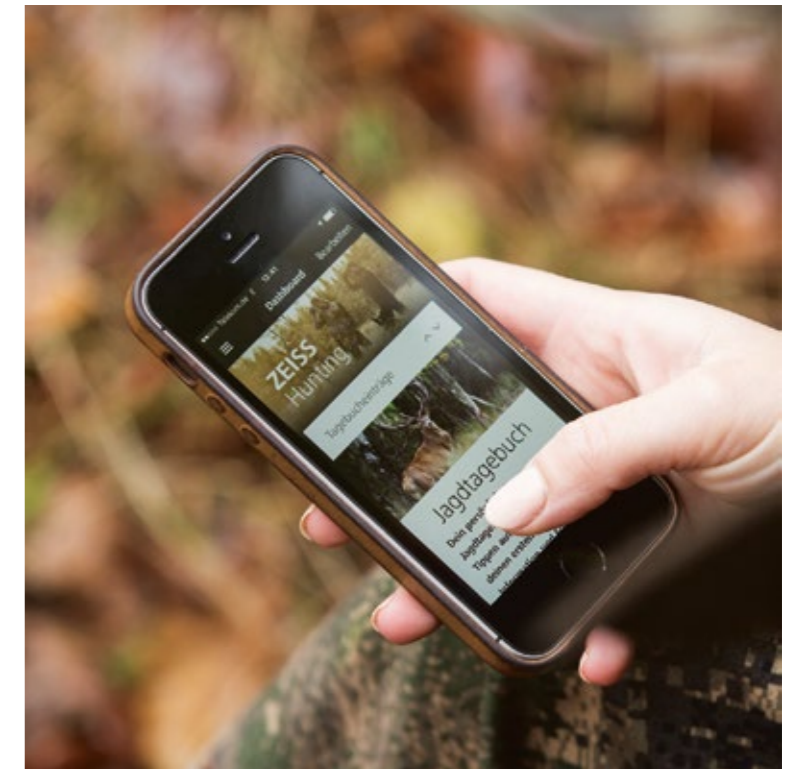

Dashboard

Overview of the main topics and direct navigation to functions.



Ballistics

Precisely calculated data for ensuring shots in compliance with the rules of good huntsmanship. For this, a comprehensive database provides more than 5,000 entries with data on manufacturers, calibres and projectiles.



Hunting diary

A multitude of parameters can be entered and saved to document the details of a hunt – including photographs and GPS data.



Weather information

Hunting-relevant weather forecast with information relating to the current location and preferred hunting grounds.



Connected Products

Connect and configure your Rangefinder via Bluetooth. Synchronize your personal ballistic profiles from the app with the Rangefinder for precise calculations.



My Equipment

Clear compilation of your hunting equipment. Important product information always at your fingertips.

THE ZEISS HUNTING APP



Available free-of-charge

Downloadable from the Apple Store or Google Play Store. Further information about the versatile functions of the app can be found at:

www.zeiss.com/hunting-app





CARL ZEISS (1816 – 1888) 200TH BIRTHDAY



CARL ZEISS AG – THE COMPANY

'DID YOU KNOW THAT ...'

RESEARCH & QUALITY TECHNOLOGY

ZEISS makes the almost invisible visible?

In collaboration with scientists from the Max-Planck Institute for Biophysics in Frankfurt am Main, the Semiconductor Manufacturing Technology division has developed an innovative transmission electron microscope for ultra-high resolution phase contrast imaging of biological materials. This high-performance microscope enables, for example, the precise examination and analysis of individual strands of DNA and their functions. As long ago as 1934, Nobel Prize winner Frits Zernike revolutionised basic biomedical research with the invention of the phase contrast microscope, which allowed better examination of transparent cell structures.

ZEISS guarantees success on the racetrack with ultimate measuring precision?

Mario Pichler from motor sports supplier Pankl Engine Systems describes the challenges of manufacturing components for Formula 1 cars as a 'knife-edge balance between lightweight construction and endurance'. Almost all Formula 1 teams rely on measuring equipment from ZEISS to ensure the precision of chassis, increase the stability of engines and make their cars even faster. ZEISS measuring equipment also plays an invaluable role in American motor racing at events like the NASCAR Sprint Cup Series, the XFINITY Series and the Camping World Truck Series. For instance, in the laboratories of

ECR Engines – a US designer, developer and builder of Chevrolet engines for racing cars – various different measuring instruments, light and electron microscopes, and analytical programs from ZEISS are used for the precise measurement and analysis of a wide range of engine components.

No fewer than 35 Nobel Prize winners conducted their research with microscopes from ZEISS?

Scientists have always placed their trust in the expertise, experience and innovative powers of ZEISS and the quality of the company's products they use in their research. One of them was Robert Koch. In the 1880s, the founder of modern bacteriology discovered the bacilli

that cause tuberculosis and cholera. In a letter to Carl Zeiss, the winner of the 1905 Nobel Prize for medicine wrote, 'A large part of my success I owe to your excellent microscopes.' Today, as in the past, scientists rely on cutting-edge technologies and instruments made by ZEISS. For instance, Roger Tsien, the American biochemist and specialist for cell biology from the University of California in San Diego. He and his fellow scientists Osamu Shimomura and Martin Chalfie discovered the green fluorescent protein (GFP) with the aid of ZEISS microscopes. In 2008, the three research scientists were jointly awarded the Nobel Prize in Chemistry.



MEDICAL TECHNOLOGY

ZEISS is actively involved in the battle against cataracts and supports eye treatment campaigns?

Cataracts are the most common cause of blindness around the globe. The clouding of the eye's natural lens is a condition that affects older people in particular. The only way to restore vision is an operation to remove the clouded lens and replace it with a clear, plastic intraocular lens (IOL). In Germany alone, the number of cataract operations performed every year amounts to almost 500,000. ZEISS offers a complete programme of solutions for the treatment of cataracts ranging from diagnostic devices and intraocular lenses to surgical microscopes and aftercare systems. ZEISS actively supports the global initiative 'Vision 2020 – The Right to Sight', which provides aid in regions with limited healthcare facilities. Incidentally, every year, cataract surgery with the aid of ZEISS medical technology saves the sight of 15 million patients around the world.

Operation microscopes from ZEISS help art restorers as well as surgeons?

A prominent example of this is the laborious restoration of *The Scream*, the famous painting by Norwegian expressionist Edvard Munch. The painting was stolen

from the Munch Museum by masked gunmen during opening hours in 2004. The painting was recovered two years later, but was found to be quite seriously damaged. Due to the painstaking precision, very high magnification and good illumination required for the task, Gry Landro, a paper and painting conservator from the Munch Museum in Oslo, examined and restored the painting with the aid



of a specially modified ZEISS OPMI PENTERO operation microscope. The painting was on view to the public again in May 2008. Usually, the ZEISS OPMI PENTERO is used around the world in the fields of neurosurgery, spinal surgery and plastic surgery.

SEMICONDUCTOR MANUFACTURING TECHNOLOGY (SMT)

A large proportion of all microchips produced around the globe are manufactured with technologies from ZEISS?

ZEISS supplies equipment for semiconductor manufacturing to the Dutch company ASML, the world's largest producer of wafer steppers and wafer scanners – extremely complex machines for manufacturing microchips. Contact between the two companies was established around 30 years ago: in 1983, ZEISS began producing the first lithography optics for Philips (today ASML); 1992 then saw the expansion of their business relations into a strategic partnership.

VISION CARE / CONSUMER OPTICS

A ZEISS telephoto lens was sold at auction for more than 450,000 US dollars?

At an auction in Boston, the camera lens used on the Apollo 15 mission in 1971 raised a hammer price

equivalent to around 400,000 euros. The ZEISS Tessar 500-millimetre f8 was used by mission commander David Scott on the Moon and in Earth's orbit. The lens went to a bidder who preferred to remain anonymous. The lens was mounted on a specially modified Hasselblad camera and was used to take almost 300 spectacular photos of the lunar surface. The camera was customised to make handling possible when wearing the thick, pressurised gloves of a spacesuit.

ZEISS makes driving safer? (DriveSafe)

Developed in collaboration with research institutes, ZEISS DriveSafe spectacle lenses are optimised to meet the specific needs of drivers. The special lens coating reduces glare by attenuating the proportion of short wavelength light. In addition to this, ZEISS DriveSafe lenses offer optimised fields of vision for so-called dynamic vision and, in return, a more relaxed view for wearers of varifocal spectacles. Former Formula 1 racing driver Christian Danner also relies on this innovative technology.



Numerous Oscar-winning films were shot with ZEISS lenses?

Cinematography lenses from ZEISS helped to create the unmistakable, atmospheric mood of numerous Oscar-winning films like *The Lord of the Rings*, *King Kong* and *Perfume: The Story of a Murderer* – the jury of the Academy of Motion Picture Arts and Sciences awarded three technical Oscars to these cinematographic innovations. In 2012, two engineers from ZEISS were presented with the prestigious Scientific and Engineering Award for the mechanical and optical design of the ZEISS Master Prime cinematography lenses – a joint development by ZEISS and camera manufacturer ARRI. In 1999, the company received the award for the concept and optical design of zoom lenses with the optical performance of prime lenses (Variable Prime) and, in 1987, for the design and development of extremely fast lenses (Super Speeds).

ZEISS makes the stars shine in the world's biggest planetariums?

The world's biggest planetarium was opened in the Japanese city of Nagoya in March 2011. At the centre of the 35-metre dome in the Nagoya City Science Museum, a ZEISS UNIVERSARIUM projector simulates the sky at night. In Moscow, an identical projector is the centrepiece of Europe's biggest planetarium (dome diameter of 25 metres). In the biggest planetarium in the USA, in the Saint Louis Science Center, a ZEISS UNIVERSARIUM projects the stars on the inner surface of a dome with a diameter of 24 metres.

Incidentally, the world's oldest ZEISS planetarium still in operation can be found in the German university city of Jena. It was opened on 18th July 1926.

That the dwarf planet Pluto was discovered with optical technology from ZEISS?

On 18th February 1930, Clyde Tombaugh, a young research assistant at the Lowell Observatory in Arizona (USA) discovered Planet X, today better known as Pluto. His discovery was made with the aid of a so-called blink comparator from ZEISS, as the German planetologist Ulrich Köhler from Gmünd found out 85 years after the discovery of Pluto. A blink comparator has an eyepiece similar to that of a microscope and is used to flick quickly, or 'blink', between two photographs of particular segments of the night sky taken at different times to identify changes.

ZEISS binoculars made literary history?

Ernest Hemingway is considered to be one of the most influential writers of the 20th century. His best known works include short stories like 'In Another Country', 'The Snows of Kilimanjaro' and the novel *To Have and Have Not*. He was awarded a Pulitzer Prize in 1953 and received the Nobel Prize in Literature in 1954. Hemingway had a passion for big-game hunting and owned several pairs of ZEISS binoculars. One photo shows him with a Turita 8x24 and he is also seen in other pictures with a Carl Zeiss Dienstglas 6x30 (military field glass). This was also expressed in his works, in which ZEISS binoculars became a part of literary history.



SPORTS OPTICS

ZEISS made the first riflescopes with reticle illumination as long ago as 1921?

ZEISS revolutionised riflescope mounting?

The introduction of the ZEISS inner rail in 1990 meant that gunsmiths no longer needed to perform the laborious tasks of gluing and drilling the mounting components to attach them to the riflescope. Since the patent expired in 2008, the ZEISS inner rail is now offered by almost all prominent European manufacturers.

ZEISS was the first to bring binoculars with mechanical image stabilisation to the market?

With the 20x60 S, ZEISS became the world's first manufacturer to launch a pair of binoculars with mechanical image stabilisation, which allowed shake-free, hand-held viewing with 20x magnification.

ZEISS TODAY AND TOMORROW

ZEISS constantly sets new standards?

Characterised by a spirit of innovation and progress, the 170-year history of the company is reflected in every idea, every product and in every service offered by ZEISS. Because, just as the world of nature constantly changes and never stands still, ZEISS works with untiring scientific curiosity and unconditional passion – always questioning the status quo and setting new standards with technical innovations.



The Zieldovier and Zieldosechs models were the first two riflescopes that ZEISS offered not only with variable magnification, but also with reticle illumination. The riflescopes featured a light tube on the side that could be fitted with an illuminating device. This accessory was supplied only at the special request of customers. A fine adjustment control regulated the brightness of the illumination to allow it to be adapted to the visibility of the game.

THE CARL ZEISS FOUNDATION

In 1889, Ernst Abbe founded the Carl Zeiss Foundation to safeguard the existence of the two companies, Carl Zeiss and SCHOTT, independent from personal ownership interests. Two years later, in 1891, he made the Carl Zeiss Foundation the sole owner of the ZEISS factory and part owner

of the SCHOTT works (Otto Schott transferred his shares in the glass works to the Foundation in 1919). In the course of a radical reform of the foundation in 2004, both Foundation-owned companies were transformed into legally independent, non-public stock corporations.

The primary objectives of the Carl Zeiss Foundation are the responsible management of the two companies and the use of the dividends generated by Carl Zeiss AG and SCHOTT AG to promote the natural

sciences, engineering sciences and mathematics at universities. The Foundation's constitution prohibits the sale of shares. Administration of the Foundation is the responsibility of the Ministries of Science in the German federal states of Baden-Württemberg and Thuringia. They form the Foundation Administration and appoint the members of the Shareholder Council, which exercises the rights of the Foundation as the sole owner of the Foundation companies.



SEE FURTHER: ZEISS AR SPORTS OPTICS APP

Technical innovation is as deeply rooted in the DNA of ZEISS as the commitment to uncompromising quality in even the smallest of details. Our new app links these two topics – and raises the ZEISS optics product experience to an entirely new level.

Thanks to the innovative ZEISS AR Sports Optics App, you can now take a look around inside our extreme-

ly complex optics products from your mobile device. Features like the distance-measuring system of the Victory Rangefinder System or adjustment of the illuminated dot in the Victory V8 are now not only made visible, but also easy to grasp.

Numerous pages of this catalogue – including the following page – serve as ‘markers’ for the app. All you need to do is hold your device above the



marker pages to discover perfectly detailed 3D models of our products. You can take a walk around each of the products, get up-close to them or take direct control of the animation. Discover what makes ZEISS a legendary name while you're there: the undying passion for precision and quality – even down to the tiniest screw.

The rangefinder is just one of the numerous products you can discover and explore with the app.

1. Download and install the ZEISS AR Sports Optics App

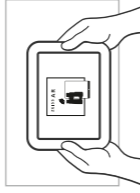

2. Activate the App and hold your device above a catalogue page that contains a ZEISS AR logo

3. Select a product and activate the animation by touch



4. Move your tablet or smartphone to discover new angles and perspectives

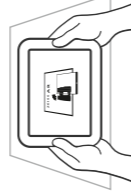

Note: always keep a part of the picture in the field of view of the camera





RIFLESCOPES FROM ZEISS

DEDICATED TO A PERFECT VIEW OF YOUR GAME

The perfect, universal riflescope for every hunter – that's naturally the dream of all mechanical and optical design engineers at ZEISS. At the same time, they know full well that it makes more sense to concentrate on the various different needs of hunters.

Riflescopes must take the needs of different hunting types and personal needs with regard to weight, magnification, field of view, handling and the brightness and clarity of the viewing image into account. Another extremely variable factor is how much individual hunters are prepared to invest.

ZEISS has found the ideal answer to this. This is based on one common factor – quality leadership – and then a broad spectrum of levels in terms of performance and price. The differences relate to optical and technical details, the selection of essential features and production volumes. Nevertheless, ZEISS firmly believes this: if there will ever be a riflescope that covers all hunting needs, then it's sure to be a riflescope from ZEISS.

Our online product guide will lead you step by step to the perfect ZEISS riflescope for your specific needs:
www.zeiss.com/productadvisor-hunting



SEE PERFECTION IN MORE DIMENSIONS

DOWNLOAD THE ZEISS AR SPORTS OPTICS APP. GAIN DETAILED INSIGHTS INTO THE QUALITY, CONSTRUCTION AND FUNCTIONALITY OF THE RIFLESCOPES FROM ZEISS.



ZEISS

Maximum precision

The world's finest and brightest illuminated dot

Revolutionary brightness and image contrast

SCHOTT High-transmission glasses

Extreme versatility

Highest magnification ranges

ZEISS VICTORY RIFLESOPES

THE UNCOMPROMISING PURSUIT OF PERFECTION

Hunting leaves little room for compromises. This is why dedicated hunters around the world place their complete trust in ZEISS Victory riflescopes – the measure of all things.

It is the sum of sophisticated features and their perfect interplay that makes riflescopes from ZEISS an indispensable hunting companion: scanning the hunting terrain delivers an image in extraordinarily sharp detail, outstanding brightness and natural colour rendition. This is made possible only by the unique interplay of transmission values of up to 95 per cent, FL lenses, SCHOTT HT glasses and extremely wide fields of view.

The handling ergonomics of Victory riflescopes are also uncompromisingly good. For instance, the world's finest and brightest illuminated dot can be precisely adjusted and easily set, while the short and compact construction ensures the best weapon handling characteristics. Their extreme long-range capabilities are one of the outstanding characteristics of the Victory riflescopes. Thanks to the new BDC (ASV) LongRange and its large adjustment range, the new ZEISS Victory V8 stands at the pinnacle of modern riflescope technology.

FACTS:

Intelligent innovations for exceptional results:

HT glass from SCHOTT:

Simply 'brighter'. The utilisation of high-transmission (HT) glass ensures a visible increase in light transmission.

Glassless reticle:

It lies in the second image plane and guarantees a constant, fine illuminated dot throughout the entire magnification range. This results in minimum target coverage and noticeably higher aiming accuracy at long distances.

LotuTec® coating:

The dust, dirt and water-repellent coating guarantees a permanently clear view.

Excellent ergonomics:

Functional control elements, intelligent illuminated dot control and robust engineering provide clear proof that the development of ZEISS riflescopes are founded on real-life hunting experiences.

True long-range shooting capability

With an adjustment range of up to 100 clicks, the BDC (ASV) LongRange (ASV LR/ASV Competition) enables accurate aiming at distances of up to 600 metres. Long distances are no longer an obstacle.

Cutting-edge technologies

Multifunction button for control of the illuminated dot and intelligent motion sensor system for automatic activation of the illuminated dot when the weapon is raised to take aim.



Short reaction time

Faster target acquisition: this is guaranteed due to the large exit pupils and a large field of view at low magnification factors.

Performance-oriented design

The centre tube diameter of 36 millimetres offers more room for optical excellence and greater reticle adjustment ranges.

Precise images

Perfect aim at all distances, thanks to parallax compensation as a standard feature.

PRODUCT PORTRAIT

THE MOST VERSATILE RIFLESCOPE: ZEISS VICTORY V8



V8 1.1–8×30

The up to 8x magnification range fulfils the needs of real-life hunting practice in driven hunts and when stalking, and is ideally suited for target acquisition with both eyes open and quick shots at short distances. An unusually wide field of view maximises the overview for shooters on driven hunts and when stalking.



V8 1.8–14×50

From driven hunts and stalking to stand hunting. The large zoom range with parallax compensation and relaxed viewing characteristics make this riflescope an ideal companion in every situation.



HT 2.5–10×50

The all-rounder for all hunting applications: whether you are shooting on the move or stand hunting, the optional BDC+ (ASV+) makes this riflescope ideal for every hunting situation. The optical concept of the ZEISS Victory HT reveals its true strengths especially in the twilight hours.



HT 3–12×56

The specialist for stand hunting at night. The SCHOTT HT glass of the brightest riflescope from ZEISS ensures maximum night hunting capability. In combination with the optional BDC+ (ASV+), the Victory HT also guarantees hunting success at long ranges.



V8 2.8–20×56

The 20x magnification and bullet drop compensation as a standard feature make this model an ideal choice for long-range shots. In addition, the 92 % transmission offers outstanding reserves for shooting into the last hours of daylight.



V8 4.8–35×60

The benchmark model of the Victory V8 line. The 35x magnification combined with the BDC (ASV Competition) stands for ultimate long-range shooting capability. The optical system of the Victory V8 impresses with consistently excellent sharpness and the highest resolution of details from minimum to maximum magnification.

ACCESSORIES



Bullet drop compensator BDC (ASV)

Direct read-out of shot distances makes the BDC (ASV) the world's most precise long-range shooting concept. This accessory enables accurate aiming at distances of up to 600 metres.



Flip cover for the Victory V8 / Victory HT

The high-quality, extremely durable front lens cap is screwed into the lens filter thread and offers perfect protection in any weather conditions. It can be fixed in any position and is suitable for use by left- and right-handed shooters. The field of view is not impaired and its handling while hunting is simplistic.

THE HIGH-PERFORMANCE RIFLESCOPE WITH A **6x ZOOM RANGE:** ZEISS CONQUEST V6

Fast and precise

The optional bullet drop compensator enables accurate aiming at maximum hunting distances. The large exit pupil allows for fast target acquisition.

Advanced

Automatic activation and deactivation of dot illumination by intelligent motion sensor technology.

Bright and sharp

FL glass and high light transmission ensure a bright, sharp and crisply defined viewing image with optimum target resolution.

Robust and reliable

The extremely robust construction and reliably engineered mechanical systems guarantee safe and sure functioning under all conditions. Quality, 'Made in Germany'.

V6 2.5 – 15x56

With the highest light-gathering power, the Conquest V6 is an excellent choice for stand hunting and, thanks to the optional BDC (ASV), is also ideal for long-range shots. The minimum coverage of the target by the illuminated reticle ensures a perfect aim.



V6 1.1 – 6x24

Its wide field of view is ideal for keeping everything in sight on driven hunts. A maximum magnification factor of 6.5x guarantees the flexibility required when hunting and intuitive handling ensures quick responses.



V6 2 – 12x50

This compact and versatile rifle scope is a reliable companion in every hunting ground. The extremely fine illuminated dot and high magnification range of the Conquest V6 2 – 12x50 bring high performance well into the twilight hours.



V6 3 – 18x50

The lightweight and lean design of this versatile rifle scope makes it ideal for medium to long-range shooting. It is also reliable and simple to use. A ballistic turret is available as an optional accessory. Reticle 6 and ballistic reticles ZBR-2 and ZMOA-2.



V6 5 – 30x50

The Conquest V6 5 – 30x50 offers a high magnification factor for long-range shots. In addition to this, it also features a wide zoom range that guarantees maximum flexibility. A further advantage is its lightweight construction and lean design. Ballistic reticles ZBR-1/ ZMOA-1, and additional Reticle 43 are available.

OPTICS KNOW-HOW

Reticles for ZEISS riflescopes

ZEISS raises the standards time and time again with the incomparably high precision of its new reticles.

Non-illuminated standard reticle

Non-illuminated reticles are versatile and precise. They are ideal for use when hunting in very good light, in the early hours of dusk or the later hours of dawn. A further advantage is that non-illuminated reticles can be used for measuring distances: the fine scales on the horizontal and vertical cross hairs between the reticle posts enable the determination of useful information about the distance to the game. As certain reticles have extremely fine cross hairs that cover very little of the target or game at long ranges, non-illuminated reticles also bring distinct advantages for sports marksmen.

Illuminated reticles

Depending on the brightness of the illuminated dot or cross, there are two fundamentally different types of illuminated reticle in the ZEISS riflescope range:

Illuminated reticles with a very bright illuminated dot – as those found, for example, in the Victory HT models – are intended for use in daylight or twilight and are particularly effective for rapid target acquisition when hunting moving game.

The second group of illuminated reticles from ZEISS are intended for use in the twilight hours. The corresponding Classic and Victory FL models feature finely dimmable illuminated dots. These enable ideal adjustment to the widely varying lighting conditions encountered in the early hours of twilight. If the illuminated dot or cross hairs were

too bright, flare would obscure the target in deep twilight. These illuminated reticles therefore provide an option for optimum adjustment of the brightness – either manually or automatically with the help of the riflescope.

ACCESSORIES



BDC (ASV) for Conquest V6
BDC (ASV) for elevation can be ordered separately for retrofiting



Throw lever for Conquest V4 and V6
For fast magnification changes when speed is a critical factor.

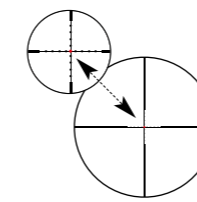

Reticle 43
With central illuminated dot
For Victory V8

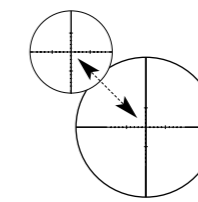

ZMOA-2
For Conquest V6

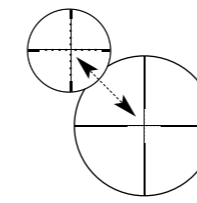

Reticle 43
Non-illuminated for Conquest V6

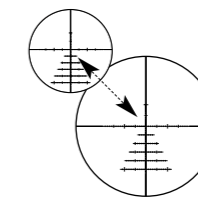

ZBR-1
For Conquest V6

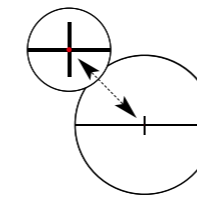

Illuminated reticle 54
For Victory V8

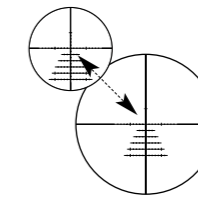

ZBR-2
For Conquest V6

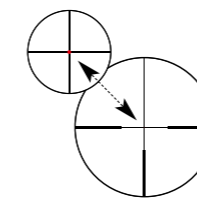

Illuminated reticle 60
For Victory V8, HT
and for Conquest V6

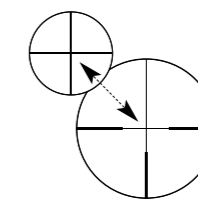

Reticle 6
For Conquest V6

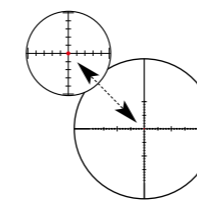

ZMOAi
For Conquest V4

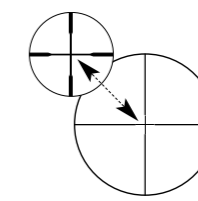

Reticle 20 (Z-Plex)
For Conquest V4

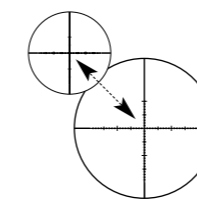

ZMOA-1
For Conquest V6, Conquest V4

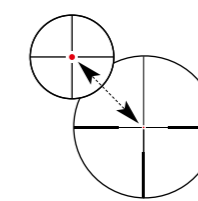

Reticle 60
For Conquest V4

PRODUCT PORTRAIT

HIGH-QUALITY OPTICS FOR **EVEN THE HARSH**EST HUNTING CONDITIONS: ZEISS CONQUEST V4

New!

Ballistic reticle

The reticle can be individually adjusted to fit the specific needs of the hunter or shooter

Ballistic turret

The large bullet drop compensation range provides hunters with the flexibility they need for a broad spectrum of hunting applications.

Functional mechanical systems

Absolute reliability: the mechanical systems also stand the test in all situations where hunters need to react on the spur of the moment.

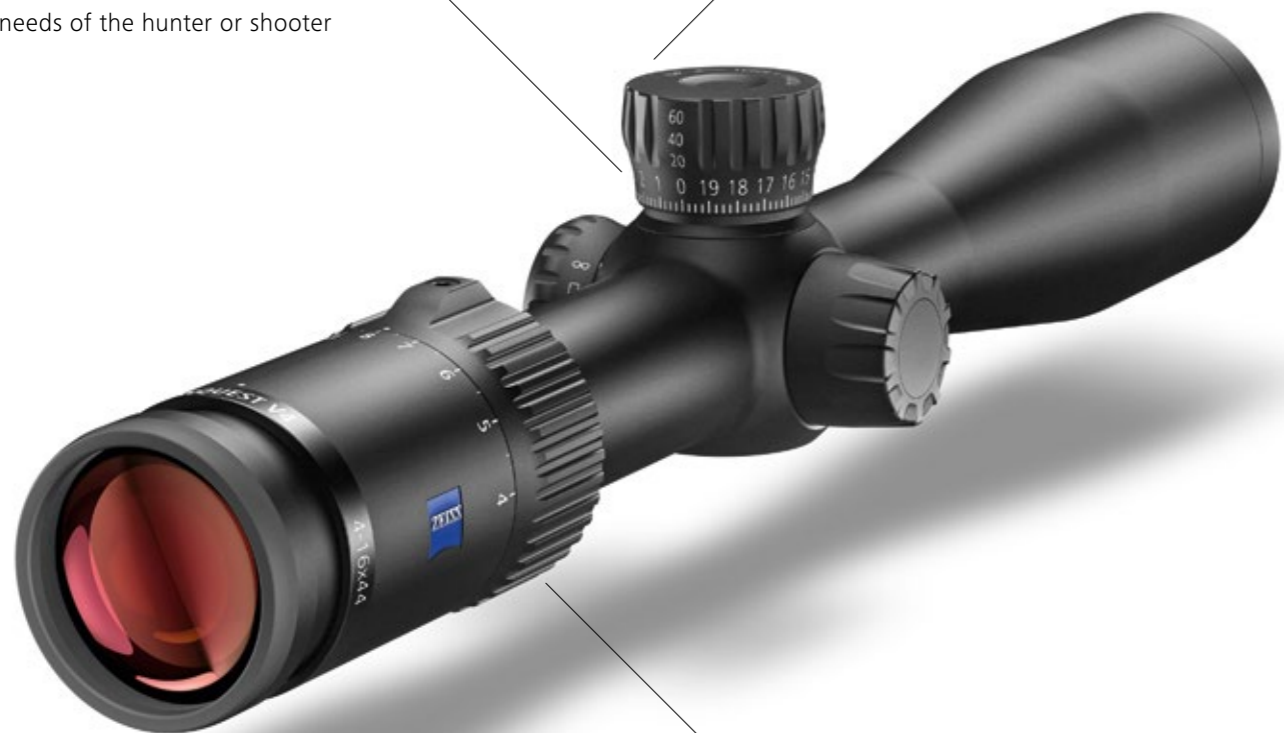

V4 1-4x24

Proven to be exactly the right riflescope for hunting at short range and in situations where fast target acquisition is essential.



V4 6-24x50

Offering 24x magnification and parallax compensation, this riflescope is the specialist for precision shooting.



V4 4-16x44

The balance between its wide field of view and magnification range make this compact riflescope ideal for all types of hunting.



V4 3-12x56

This riflescope is suitable for stand hunting and for long-range shots. The large objective lens diameter and illuminated reticle guarantee aiming accuracy, even in unfavourable light.



BINOCULARS FROM ZEISS

VIEWED OVER TIME: THE BEST

There always has been something legendary about ZEISS binoculars. A legend founded on exceptional optical performance, outstanding ergonomics, robust construction and a whole world of innovations that have constantly expanded the limits of the technically possible.

So it's no wonder that generations of hunters swear by 'their' ZEISS binoculars. These dependable hunting companions will one day be bequeathed to the next generation, along with the stories experienced with them. Many of them are still in constant use today. Nevertheless, time never stands still. Today, the three product lines

from ZEISS – Victory, Conquest and Terra – offer the highest quality for a wide variety of different hunting needs. From special binoculars for stand hunting at night to compact binoculars for everyday situations. But however much the various binoculars may differ in their specialisation and performance, they must all work hard to earn the name founded on more than 170 years of research, the finest arts of engineering and an undying passion for excellence: ZEISS.

Our online product guide will lead you step by step to the perfect ZEISS binoculars for your specific needs: www.zeiss.com/productadvisor-hunting



YOU CAN NOW TAKE A CLOSER LOOK AT THEIR QUALITIES
WHAT MAKES OUR BINOCULARS UNIQUE, AND HOW ARE THEY CONSTRUCTED?
THE ZEISS AR SPORTS OPTICS APP PROVIDES THE ANSWERS.



ZEISS

Top of the class

Extremely wide-angle fields of view

Precise and intuitive handling

Rapid focusing

Unique carrying comfort

Very lightweight, excellent grip characteristics

Best image quality

Bright, high-contrast image, natural colour fidelity

ZEISS VICTORY BINOCULARS

FOR CONFIDENT, FARSIGHTED DECISIONS

Do you discover and recognise new perspectives where others see only limits and give up? Do you demand only the best from yourself, and accept nothing less? Do you enjoy having the freedom to make confident decisions? If your answer is yes, you simply can't ignore the Victory line binoculars from ZEISS.

Anyone who has ever held a zeiss Victory model in their hands will never want to hand it back – for good reason. Even the tiniest details are thought through to excellence. Innovative optical and mechanical systems interact with ergonomics with the ultimate perfection of a winning team to deliver the viewing image you need at the decisive moment. Sharp, precise, clear, uncompromising. Even in the most unfavourable conditions. At the same time, the construction of the

Victory line of binoculars from ZEISS is amazingly robust.

With a ZEISS Victory in your hands, you have everything in sight and remain in perfect control of the situation, however unexpected or unusual it may be. Whether in the darkest hours of night or at the most extreme ranges. Whether lying in wait for the stag of your life or hunting game in mountainous terrain. Your ZEISS Victory binoculars will soon become your most invaluable hunting companion. Regardless of whether you choose an all-rounder like the Victory SF, a specialist like the Victory HT or the particularly compact Victory Pocket. They all offer you the opportunity to collect unique insights and personal experiences that will become treasured memories.

FACTS:

Intelligent innovations for exceptional results:

Triple-link bridge:

Constructional stability and robustness that stands up to even the harshest conditions.

Ultra-FL lens system:

Ensures natural colour fidelity, high contrast and finest detail rendition.

Magnesium materials:

The combination of extremely lightweight and high strength materials guarantees quality that lasts for generations.

LotuTec® coating:

The dust, dirt and water-repellent coating guarantees a permanently clear view.

ErgoBalance concept:

Perfectly balanced weight distribution guarantees fatigue-free observation.

ZEISS FieldFlattener technology:

Extreme edge sharpness, even with wide fields of view.

Smart Focus concept:

Optimum location of the focusing wheel ensures intuitive, fast and precise focusing.

TURNING SENSE INTO CERTAINTY: ZEISS VICTORY RANGEFINDER SYSTEM

New!

Everything you need

Storage capability for up to nine personalised ballistics profiles set up beforehand in the Hunting App.

Binocular real-time ballistics system

The various measuring functions of the rangefinder take a multitude of relevant data into account and use them to calculate the precise setting for the BDC (ASV).



All you need at a glance

The rangefinder determines the precise target distance up to a maximum range of 2,300 metres.

An eye for relevant data

Every measurement takes the physical and environmental factors, such as temperature and air pressure, into account when making the calculation.

THE ZEISS HUNTING APP

Entirely new possibilities

The capabilities of the rangefinder system are perfected by the ability to synchronise it with the ZEISS Hunting App via Bluetooth. This allows the hunter's own ballistics data to be transferred to the rangefinder for configuration of the system.

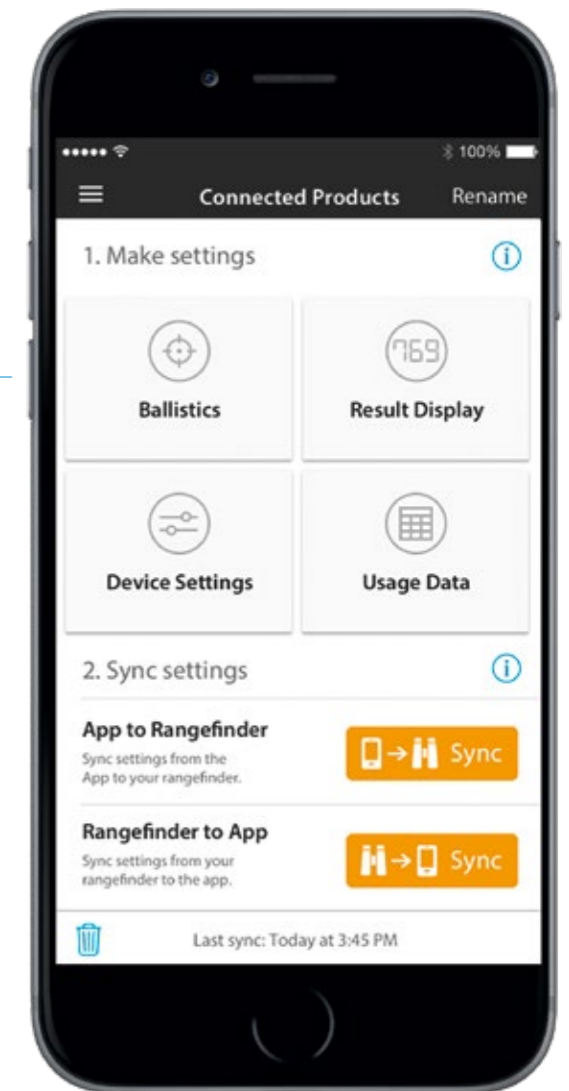

Ultimate ergonomics and handling

The TripleLink Bridge stands for rigid construction paired with ergonomic design. State-of-the-art magnesium alloys enable featherweight construction.

Fantastic handling

The Smart Focus concept and the optimum location of the focusing wheel guarantees a pin-sharp viewing image in seconds.

An exceptional viewing experience

The Ultra-FL lens system guarantees natural, true-to-life colour rendition, a bright viewing image and finest resolution of details. The use of SCHOTT HT glass in the optical system guarantees the high transmission value of 92 per cent.

SCHOTT
HT GLASS

PRODUCT PORTRAIT

THE MOST VERSATILE PREMIUM BINOCULARS IN THE HISTORY OF ZEISS: ZEISS VICTORY SF

Superior vision

Incomparably broad fields of view provide a perfect overview in difficult terrain and a close focus distance of 1.5 metres allows detailed exploration of the immediate vicinity.



PRODUCT PORTRAIT

MADE FOR THE TWILIGHT HOURS:

ZEISS VICTORY HT 54



A brighter outlook

The ZEISS Victory HT is not simply bright: the integration of FL lenses increases its resolving power and brings outstanding brilliance to the viewing image.

SCHOTT
HT GLASS

Built to last a lifetime

The use of magnesium alloys combining light weight with high rigidity guarantees a long and reliable service life.

Form follows intuition

The large focusing wheel of the Comfort Focus concept ensures superior handling ergonomics, even when wearing gloves.

Tradition revisited

The elegant design is the continuation of the design concept of the ZEISS Dialyt – timeless and functional.



RF 8/10x42

The compact rangefinder model. The binocular real-time ballistics system can be synchronised with the Hunting App via Bluetooth.



RF 8/10x54

All the qualities of the rangefinder system in combination with powerful optics. The model for users who look for the best when it comes to optical performance.



SF 8/10x42

With a value of 148 metres at 1,000 metres, the field of view of these binoculars is absolutely outstanding. Thanks to the Smart Focus concept, the outstanding optical performance is also complemented by perfect ergonomics.



HT 8/10x54

The models with the 54-millimetre objective lens are among the most powerful night-hunting binoculars from ZEISS. With a light transmission of 95 per cent, these binoculars guarantee maximum performance in the hours of dusk and dawn. At the same time, the 8x54 impresses with outstanding ergonomics and a large exit pupil.



FL 8/10x32

The special lenses with FL glasses minimise colour fringing, ensure superior edge sharpness and thus leads to a sharp viewing image with the finest resolution of details. In addition to this, the compact size and low weight make them ideal for prolonged observation.



Pocket 8/10x25

Proven high-performance binoculars for virtually all observation situations. The compact size and light weight allow them to be conveniently carried in smaller jacket pockets when not in use.

ACCESSORIES



Air Cell Comfort carrying strap

The carrying strap enables binoculars with lens diameters greater than 30 millimetres to be carried much more comfortably. Embedded air cells make the strap much more comfortable to wear, while quick-release fasteners make it easy to attach and remove. The strap length can be adjusted to meet the user's needs.



Comfort carrying harness

Made from premium materials, the harness prevents neck strain and distributes the weight of the binoculars over the upper body. When moving about, the binoculars remain steady and any uncontrolled swinging is prevented. The harness offers outstanding carrying comfort and enables binoculars to be quickly and easily fixed when not in use.

PRODUCT PORTRAIT

PERFECT ALL-ROUNDERS: ZEISS CONQUEST HD

Light in the darkness

High transmission values are an essential prerequisite for impressive observation in the twilight hours.

Perfect balance

Compact dimensions, low weight and modern a design come together to create exemplary ergonomics.

Nature in HD

The highest resolution of details and natural colour rendition of the HD lens system lets you experience new standards of optical excellence.



HD 8/10x32

Thanks to the extra-wide field of view of the HD lens systems, compact dimensions, low weight and carrying comfort, the Conquest HD 8/10x32 is the ideal, high-performance companion for every situation.



HD 8/10/15x56

This version is the specialist for situations in unfavourable light and impresses with a bright, high-contrast viewing image. The 15x56 is supplied complete with a tripod adapter.



HD 8/10x42

Exceptional quality and performance – Made in Germany. Ideal for users who are looking for sharpness, high resolution of details, natural colour rendition and outstanding quality in the close focusing range.

ZEISS IN PRACTICE



Care and cleaning tips from ZEISS

LotuTec® is a resilient and abrasion-resistant lens coating with a special surface and strong lotus effect that reduces the adhesion of water droplets and dirt on lenses. The use of a ZEISS lens cleaning cloth is recommended for cleaning lens surfaces. Coarse dirt on lenses – for example, sand, mud or soil – must not be wiped off: it should only be removed by rinsing with clear water or with a clean lens brush with soft, fine bristles.

PERFECT FOR EVERY TRIP: ZEISS TERRA ED

Ergonomic

Focusing with a ZEISS Terra ED is made particularly quick and easy by the smooth action of its large, intuitively placed focusing wheel.



Compact, light and robust

The glass-fibre-reinforced, waterproof casing of the ZEISS Terra ED resists even the toughest outdoor situations.

Proven excellence

The use of SCHOTT ED glass and hydrophobic multicoating of exposed lens surfaces fulfils the highest optical demands.

SCHOTT
ED GLASS



ED Pocket 8/10×25

In its class, the extremely light and compact Terra ED Pocket delivers an outstanding viewing experience and impresses with intuitive handling.



ED 8/10×32

Impressive images, precise focusing and compact size are the characteristic features of the 32-millimetre version of the Terra ED.

ZEISS IN PRACTICE



Image: Klaus Fengler

Stefan Glowacz, extreme climber

Following his impressive victories at the Sport Roccia in Bardonecchia and the Rock Masters in Arco, the runner-up in the world climbing championships decided to end his professional career in 1993. Today, he climbs the remote and unexplored walls of the world and organises expeditions. In this, he places his absolute trust not only in his vast store of expertise and experience, but also in binoculars from ZEISS – for example, the Terra ED Pocket.



ED 8/10×42

A bright image, outstanding resolution of details and comfortable viewing characteristics. In combination with optimum ease of handling, these perfectly describe the outstanding properties of the Terra ED 42.

OPTIMUM VISIBILITY, **EVEN IN** **THE LIGHT OF A NEW MOON:** ZEISS VICTORY NV

Superior image intensifier tube

The intensifier tube with a light amplification factor of around 20,000 contains a micro-channel plate (MCP) for the generation of sharp, finely detailed images.

Perfect interplay

Available light is gathered by the 62-millimetre objective lens and focused on the extremely sensitive photocathode.



Robust construction

The optical and mechanical systems of the Victory NV are protected by its waterproof, rubber-armoured, nitrogen-filled casing.



ZEISS Mono

The 3×12 is a powerful mini-telescope with 3× magnification. It transforms Victory* and Conquest binoculars with objective lens diameters of more than 30 millimetres and more and the Dialyt 8×56 GA into high-performance spotting scopes at the flick of a wrist by attaching it to the eyepiece with an adapter ring. Can also be used separately as a magnifier in the close focus range.

* Not SF



ZEISS Mono

For a precisely detailed view at sporting events, in the theatre or at longer distances outdoors: The Monos with ZEISS T* multicoating impress with a bright and clear viewing image and, depending on the model, can also be used as magnifiers.



20×60 S

Superlative binoculars in every respect: developed for the longest distances, and even used on missions to the International Space Station (ISS). The exceptional light transmission of the Porro prism system guarantees the brightest viewing images with outstanding resolution of the finest details even at 20× magnification. The technically unique mechanical image stabilisation system of the 20×60 T* S ensures a perfect viewing experience: the unavoidable shake always encountered when observing with handheld binoculars can be easily eliminated at the press of a button.



5.6×62 NV

State-of-the-art image intensifier tubes amplify even the lowest levels of light to make the game observed appear 20,000 times brighter. In the complete absence of light or residual light, the integrated IR-LED can be activated at the touch of a button. The LED radiates light in the infrared spectrum and allows observation with the NV device at distances of around 50 metres. By attaching a torch with an IR filter, illumination can be extended to several hundred metres.



SPOTTING SCOPES FROM ZEISS

DISCOVER **THE HEART AND SOUL** OF THE NATURAL WORLD

On the one hand, curiosity and open-mindedness; on the other, high-tech spotting scopes from ZEISS. When these come together, every encounter with the world of nature becomes a unique experience.

The world of nature is fascinating wherever you happen to be – in extreme environments like the Antarctic and the Amazon Basin, as well as close to your home. This is why so many people have discovered their passion for birdwatching and wildlife observation. It also explains why there are so many different demands on the optical equipment used.

Spotting scopes from ZEISS fulfil these demands in a variety of ways – from natural reproduction of colours,

the finest rendition of details and outstanding brightness and contrast to wide fields of view and breathtakingly powerful magnification.

Qualities that make ZEISS spotting scopes firm favourites around the globe and provide the quality that makes it easier for people to get closer to nature than ever before and experience more moments of true fulfilment every day. No matter whether you are watching the migration of enormous herds of animals or the flight of a single bird.

Our online product guide will lead you step by step to the perfect ZEISS observation optics for your specific needs:
www.zeiss.com/productadvisor-hunting



ZEISS VICTORY SPOTTING SCOPES

A NEW DIMENSION OF OBSERVATION

The creation of the new on established foundations: this is one of the motors of progress so characteristic of ZEISS. One that has been realised with particular success in the Victory Harpia from ZEISS.

This spotting scope features the Dual Speed Focus system with fast switching from close to long range and options for fine focusing and sharpness correction.

One of the many innovations of this high-performance spotting scope from ZEISS is that magnification and focusing are controlled with

collars on the body of the scope and not, as usual, with the eyepiece. This enables very fast adaptation to the current situation and brings dedicated birdwatchers and wildlife enthusiasts even more fascinating encounters with the world of nature.

Further unquestionable benefits are the 72° angle of view and the respective, model-specific close-focus distances of 3.5 and 4.5 metres. These values make the Victory Harpia ideal for observation on a larger scale – for example, on the water or in woodland – as well as at closer range.

FACTS:

Intelligent innovations for exceptional results:

FL glass:

Natural colour fidelity, high contrast, brilliance and the finest detail rendition.

LotuTec® coating:

The dust, dirt and water-repellent coating guarantees a permanently clear view.

Dual Speed Focus:

Precise focusing with automatic switch between fast and fine-focusing drive.

Magnesium materials:

The combination of extremely lightweight and high strength materials that last for generations.

High magnification factors

Sharp image at extreme distances

Outstanding ergonomics

Large control elements with smooth action

Optimum performance

Objective lens diameters of up to 95 millimetres

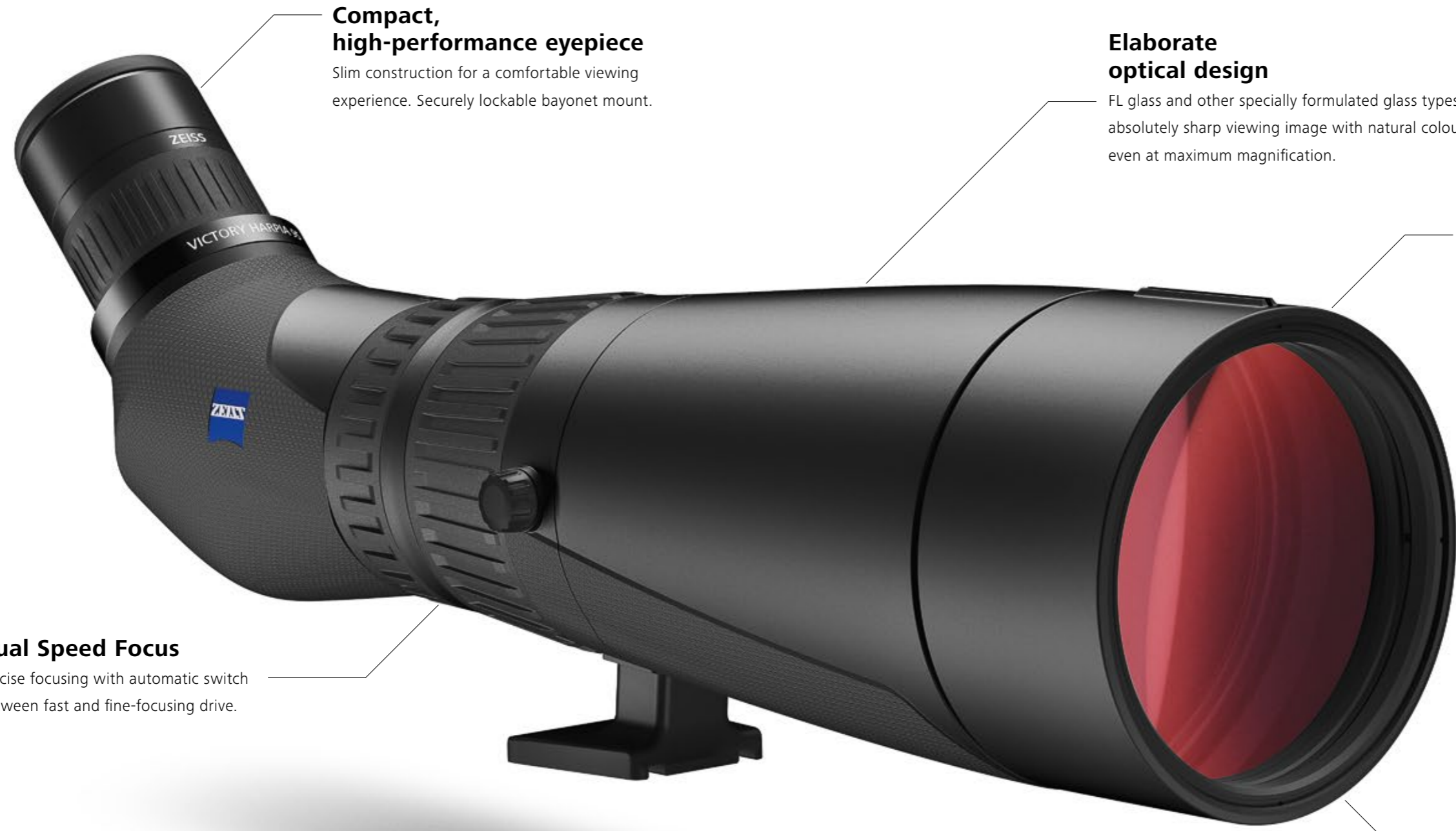

Compact, high-performance eyepiece
Slim construction for a comfortable viewing experience. Securely lockable bayonet mount.

Elaborate optical design
FL glass and other specially formulated glass types ensure an absolutely sharp viewing image with natural colour fidelity, even at maximum magnification.

ComfortVision Concept
Subjective angle of view of 72° throughout the entire zoom range for a noticeably greater overview of the terrain.

Dual Speed Focus
Precise focusing with automatic switch between fast and fine-focusing drive.

LotuTec® coating
A clear view in all weather conditions. Raindrops and dirt simply roll off the lens.

PRODUCT PORTRAIT

THE MOST POWERFUL SPOTTING SCOPE: ZEISS VICTORY HARPIA



Harpia 95

The unusual optical system features a 3x wide-angle zoom, up to 70x magnification and an objective lens diameter of 95 millimetres. The extremely wide fields of view prove their worth in every situation. The Harpia 95 also features precise focusing with convenient automatic transition from rapid to fine adjustment, even at high magnification factors.



Harpia 85

With the exception of its objective lens diameter of 85 millimetres, this version offers the same overall advantages as the Harpia 95. Thanks to the use of FL glasses and other specially formulated glass types, the Harpia 85 also delivers an absolutely sharp viewing image with natural colour fidelity, even at maximum magnification. And a subjective angle of view of 72° throughout the entire zoom range provides a noticeably greater overview of the terrain.

ACCESSORIES



Ever-ready carrying case for the Victory Harpia

The case offers reliable protection against all kinds of weather and wet conditions, is comfortable to carry and enables fast readiness of the spotting scope for use. The caps for the eyepiece and the objective lens can be securely attached to the case to prevent loss.



Ever-ready carrying case for the Conquest Gavia

Developed especially for the Conquest Gavia, the case protects the spotting scope against environmental influences such as moisture and dirt. In addition to this, optimum carrying comfort, fast readiness of the spotting scope for use and an option for attaching the eyepiece and objective lens cap to the case make it an invaluable part of the equipment.

ACCESSORIES



Tripod Professional

The ZEISS Tripod Professional fulfils the most demanding requirements with regard to compatibility and loading weight and enables particularly smooth panning and tilting. It is specifically suitable for use with our Victory products and for digiscoping.



Long Balance Plate

Our Long Balance Plate is the ideal solution to perfectly balance your spotting scope, especially when digiscoping.



Adapters for commonly available astro eyepieces

1¼" adapter for astronomical telescopes

2" adapter for astronomical telescopes

Bracket adapter for the ZEISS Conquest Gavia

Adapters for DiaScope eyepieces on astronomical telescopes

The powerful DiaScope eyepieces with T* multicoating are also ideal for observing the stars. The adapters are available for telescopes with 1¼" and 2" mounts. The astro adapters can be used to connect both the 12.8-millimetre, wide-angle eyepiece or either of the two zoom eyepieces (8.4- to 25.1-millimetre and 6.7- to 25.1-millimetre focal length) to astronomical telescopes.

Four different adapters

In combination with the ExoLens® bracket holder, the bracket adapter makes it easy to attach a smartphone to a spotting scope. This enables the use of the high magnification of a spotting scope for photography with a smartphone.

THE EXPLORER'S COMPANION: ZEISS CONQUEST GAVIA 85



Brilliant

Roof prism system with high optical precision.

Ergonomic

Large focusing ring for precise handling.

Light

Magnesium body and compact dimensions for outdoor adventures.

High-detail resolution

HD lens system for a bright and clear viewing image.



Gavia 85

This spotting scope with an 85-millimetre objective lens is particularly lightweight and compact. This makes it the ideal instrument for close and long-range observation, especially in difficult-to-access regions. A unique feature in this class is the short close-focus range that makes the observation of small subjects such as songbirds a fascinating natural experience.

ACCESSORIES



ExoLens® Bracket

The combination of the Exo-Lens Bracket and an appropriate adapter enables quick and easy attachment of a smartphone to a spotting scope or a pair of binoculars for use as a digiscoping camera.



1.25" astro adapter

For mounting standard astro eyepieces.



ZEISS photo adapter

Whether for still pictures or film, the photo adapter (for M49, M52 or M58 filter threads) enables direct attachment of a digital camera to the Conquest Gavia 85 and transforms the spotting scope into a powerful telephoto lens.

ZEISS ever-ready case

The ever-ready case for the Conquest Gavia 85 is designed to provide reliable protection, optimum carrying comfort and, above all, fast readiness of the spotting scope for use. The eyepiece and objective lens caps can be securely attached to the case when not in use.



PRODUCT PORTRAIT

BRIDGING THE DISTANCE: ZEISS DIALYT



Dialyt

The light and compact 'hunter's spotting scope' was developed especially for fast and precise target identification at extreme distances. A waterproof, non-fogging, construction, reliable functioning and simple handling make it the ideal companion for hunting in flat, open country or in rugged mountainous terrain.

ACCESSORIES

Tripod mount

The Dialyt 18–45x65 can be rested on a rucksack or supported against a tree trunk for steady viewing and also features a field-tested tripod mount. In the case of a lack of natural support, or for longer periods of observation, it is advisable to mount the spotting scope on a carbon tripod from ZEISS. Another alternative would be the use of a lightweight monopod for support.



A DIVERSITY OF DEVELOPMENTS: ZEISS RIFLESCOPES

Victory riflescopes	V8				
Model	1.1–8×30	1.8–14×50	2.8–20×56	4.8–35×60	
Magnification	1.1–8×	1.8–13.5×	2.8–20×	4.8–35×	
Effective lens diameter	10.6–30 mm	18.6–50 mm	27.5–56 mm	48.1–60 mm	
Exit pupil diameter	9.9–3.9 mm	10.3–3.7 mm	9.8–2.8 mm	9.9–1.4 mm	
Twilight factor	3.1–15.5	5.1–26	7.9–33	13.6–45.8	
Field of view at 100 m	39.6–5.4 m	23–3.1 m	15.5–2.1 m	8.6–1.2 m	
Objective viewing angle	22.2°–3°	13.1°–1.8°	8.9°–1.2°	4.9°–0.7°	
Diopter adjustment range	–3.5/+2 dpt				
Eye relief	95 mm				
Parallax free	100 m	50 m–∞			
Vertical adjustment range at 100 m	500 cm	310 cm	210 cm	130 cm	
Lateral adjustment range at 100 m	320 cm	200 cm	135 cm	85 cm	
Adjustment per click at 100 m	1 cm			0.5 cm	
Centre tube diameter	36 mm				
Eyepiece tube diameter	46 mm				
Objective tube diameter	36 mm	56 mm	62 mm	67 mm	
LotuTec®/Nitrogen filled	yes/yes				
Water resistance	400 mbar				
Operating temperature	–25°C/+50°C				
Length	303 mm	343 mm	350 mm	402 mm	
Illuminated reticles	54, 60	60	60	43, 60	
Weight with illuminated reticle	without inner rail with inner rail	600 g 620 g	710 g 730 g	830 g 855 g	970 g 1,000 g
Part number (XXXXXX-XXXX-XXX)	without inner rail with inner rail	52 21 07- 52 21 06-	52 21 17- 52 21 16-	52 21 37- 52 21 36-	52 21 47- 52 21 46-
Choice of illuminated reticles (xxxxxx-XXXX-xxx)	43 54 60	– -9954- -9960-	– – -9960-	– – -9960-	-9943- – -9960-
Bullet drop compensator (ASV) (xxxxxx-xxxx-XXX)	without BDC BDC (elevation) BDC (elev. and windage)	–000 – –	–000 -040 -050	– -040 -050	– -040 -050
		–	BDC (ASV) LR	BDC (ASV) LR	BDC (ASV) Comp.

Example for a complete order number for Victory V8 1.8–14×50 with inner rail, ret. 60, ASV LR (elevation): 522116-9960-040
Subject to changes in design and scope of delivery as a result of ongoing technical development.

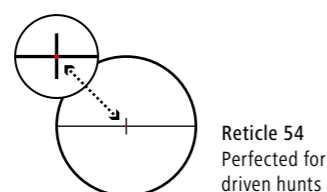
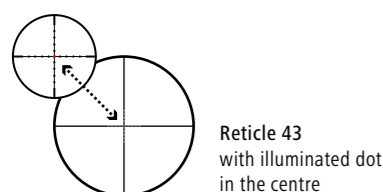

Victory riflescopes	HT		
Model	2.5–10×50	3–12×56	
Magnification	2.5×–10×	3×–12×	
Effective lens diameter	37.7–50 mm	44–56 mm	
Exit pupil diameter	15–5 mm	14.9–4.7 mm	
Twilight factor	7.1–22.4	8.5–25.9	
Field of view at 100 m	14.8–4.1 m	12.5–3.5 m	
Objective viewing angle	8.5°–2.3°	7.2°–2°	
Diopter adjustment range	–4/+2 dpt		
Eye relief	90 mm		
Parallax free	100 m		
Vertical adjustment range at 100 m	140 cm	120 cm	
Lateral adjustment range at 100 m	140 cm	120 cm	
Adjustment per click at 100 m	1 cm		
Centre tube diameter	30 mm		
Eyepiece tube diameter	42 mm		
Objective tube diameter	56 mm	62 mm	
LotuTec®/Nitrogen filled	yes/yes		
Water resistance	400 mbar		
Operating temperature	–25°C/+50°C		
Length	321 mm	347 mm	
Illuminated reticles	60	60	
Weight with illuminated reticle	without inner rail with inner rail	525 g 550 g	573 g 598 g
Part number (XXXXXX-XXXX-XXX)	without inner rail with inner rail	52 24 25- 52 24 24-	52 24 35- 52 24 34-
Choice of illuminated reticles (xxxxxx-XXXX-xxx)	43 54 60	– – -9960-	– – -9960-
Bullet drop compensator (ASV) (xxxxxx-xxxx-XXX)	without BDC BDC (elevation) BDC (elev. and windage)	–000 -010 -020	–000 -010 -020
		BDC+ (ASV+)	BDC+ (ASV+)

Subject to changes in design and scope of delivery as a result of ongoing technical development.



Conquest riflescopes		V6				
Model		1.1-6x24	2-12x50	2.5-15x56	3-18x50	5-30x50
Magnification		1.1-6.5x	2-12x	2.5-15x	3-18x	5-30x
Effective lens diameter		10.5-24 mm	19.4-50 mm	24.3-56 mm	28.6-50 mm	47.3-50 mm
Exit pupil diameter		9.5-3.7 mm	9.7-4.2 mm	9.7-3.7 mm	9.5-2.8 mm	9.5-1.7 mm
Twilight factor		3.1-12.5	5.7-24.5	7.1-29.0	8.5-30.0	14.1-38.7
Field of view at 100 m		38.1-6.6 m	20.5-3.4 m	16.4-2.7 m	12.4-2.1 m	7.4-1.2 m
Objective viewing angle		21.6°-3.8°	11.7°-2.0°	9.4°-1.6°	7.1°-1.2°	4.2°-0.7°
Diopter adjustment range		+2/-3 dpt				
Eye relief		90 mm				
Square adjustment range at 100 m		300 cm	250 cm	200 cm	300x170 m	180x100 m
Adjustment per click at 100 m		1 cm			1/4 MoA (0.7 / 100 m)	
Centre tube diameter		30 mm				
Eyepiece tube diameter		45.5 mm				
Objective tube diameter		30 mm	56 mm	62 mm	56 mm	56 mm
LotuTec®/Nitrogen filled		yes / yes			LotuTec® / ZEISS T*	
Water resistance		400 mbar				
Operating temperature		-25/+50°C				
Length		290 mm	335 mm	352 mm	338 mm	380 mm
Weight	without inner rail	505 g	620 g	690 g	630 g	740 g
	with inner rail	545 g	655 g	725 g	not available	not available
Order number	without inner rail	52 22 05	52 22 25	52 22 35	52 22 41	52 22 51
	with inner rail	52 22 04	52 22 24	52 22 34	-	-
Choice of reticles (XXXXXX-XXXX-XXX)	60	9960	9960	9960	-	-
	20	-	-	-	9906	9906
	43	-	-	-	-	9943
	ZMOA-2	-	-	-	9994	-
	ZMOA-1	-	-	-	-	9993
	ZBR-2	-	-	-	9992	-
	ZBR-1	-	-	-	-	9991
Bullet drop compensator (ASV) (XXXXXX-XXXX-XXX)	BDC (ASV)	-	060	060	-	-
	Ballistic Turret	-	-	-	070	070

Subject to changes in design and scope of delivery as a result of ongoing technical development.

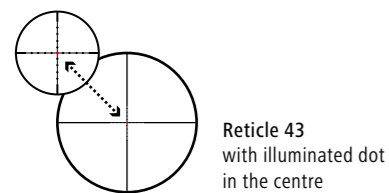

Reticle 43 with illuminated dot in the centre

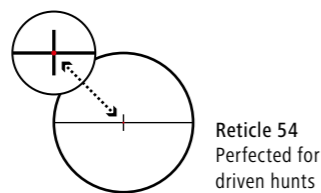

Reticle 54 Perfected for driven hunts



Reticle 60 extremely fine and bright illuminated dot

Conquest riflescopes		V4							
Model		1-4x24		3-12x56		4-16x44		6-24x50	
Magnification		1	4	3	12	4	16	6	24
Effective lens diameter		12.1 mm	24 mm	27.7 mm	56 mm	33.2 mm	44 mm	44.9 mm	50 mm
Exit pupil diameter		11.9 mm	6 mm	9.2 mm	4.7 mm	8.5 mm	2.8 mm	7.5 mm	2.1 mm
Twilight factor		3.5	9.8	9.1	25.9	11.5	26.5	16.4	34.6
Field of view		38 m	9.5 m	12.7 m	3.2 m	9.5 m	2.4 m	6.3 m	1.6 m
Angular field of view, real		21.5°	5.4°	7.2°	1.8°	5.4°	1.4°	3.6°	0.9°
Diopter range		+2/-3 dpt							
Eye relief		90 mm							
Parallax setting		91.4 cm				45.7-∞ cm			
Adjustment range at 100 m		300 cm		200 cm		230x175 cm		230x175 cm	
Adjustment per click at 100 m		1,4 cm		0.7 cm					
Centre tube diameter		30 mm							
Eyepiece tube diameter		44 mm							
Lens tube diameter		30 mm		62 mm		50 mm		56 mm	
Coating/(LotuTec®/Nitrogen filled)		yes / yes							
Water resistance		400 mbar							
Operating temperature		-25/+55°C							
Length		256 mm		368 mm		356 mm		368 mm	
Weight	without inner rail	470 g		610 g		640 g		690 g	
	with inner rail	522905		522925		522931		522951	
Part number (XXXXXX-XXXX-XXX)	without ill. reticle	-		522921		522931		522951	
	with ill. reticle	522905		522925		-		522955	
Choice of reticles (XXXXXX-XXXX-XXX)	60	9960		9960		-		-	
	20	-		9920		9920		-	
	ZMOA-2	-		-		9994		-	
	ZMOA-1	-		-		-		9993	
	ZMOAi-1	-		-		-		9993	
	ZBR-2	-		-		9992		-	
	ZBR-1	-		-		-		9991	
Bullet drop compensator (ASV) (XXXXXX-XXXX-XXX)	BDC (ASV)	-		-		080		080	
	Ballistic Turret	-		-		080		080	

Subject to changes in design and scope of delivery as a result of ongoing technical development.

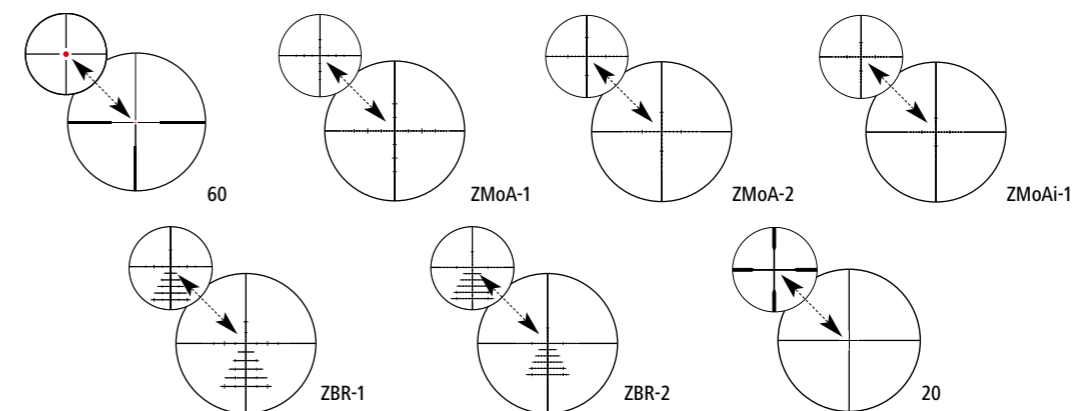

PATHFINDING SOLUTIONS: ZEISS RANGEFINDER SYSTEM AND BINOCULARS

Victory Rangefinder System Model	RF System			
	8×42	10×42	8×54	10×54
Magnification	8×	10×	8×	10×
Effective lens diameter	42 mm		54 mm	
Exit pupil diameter	5.3 mm	4.2 mm	6.8 mm	5.4 mm
Twilight factor	18.3	20.5	20.8	23.2
Field of view	135 m	115 m	120 m	110 m
Subjective angle of view	62° Ww	66° Ww	55° Ww	63° Ww
Close-up setting limit	2.5 m		3.5 m	
Diopter adjustment range	+/-3 dpt.		+/-3 dpt.	
Eye relief	17 mm		14 mm	
Pupil distance	53.5–76 mm		58.5–76 mm	
Lens type	FL			
Prism system	Abbe-König			
Coating	LotuTec®/T*			
Nitrogen filling	yes			
Waterproof	400 mbar			
Operating temperature	-25/+63°C			
Length	166 mm		195 mm	
Width with an eye spacing of 65 mm	121 mm		136 mm	
Weight	895 g	915 g	1,095 g	1,115 g
Measuring range	10–2,300 m			
Measuring accuracy	±1 to 600/±0.5 % over 600 m			
Measuring duration	<0.3 Sec			
Laser wavelength	905 nm			
Laser beam divergence	1.6×0.5 nm			
Battery	1×3V Type CR 2			
Battery life at +20°C	>2.500×			
Order number	52 45 48	52 45 49	52 56 48	52 56 49

Subject to changes in design and scope of delivery as a result of ongoing technical development.

Victory binoculars Model	SF		HT		FL	
	8×42	10×42	8×54	10×54	8×32	10×32
Magnification	8×	10×	8×	10×	8×	10×
Effective lens diameter	42 mm		54 mm		32 mm	
Exit pupil diameter	5.3 mm	4.2 mm	6.7 mm	5.4 mm	4 mm	3.2 mm
Twilight factor	18.3	20.5	20.7	23.2	16	17.9
Field of view at 1,000 m	148 m	120 m	130 m	110 m	140 m	120 m
Subjective viewing angle	64° Ww		60° Ww	63° Ww	64° Ww	69° Ww
Close focusing distance	1.5 m		3.5 m		2 m	
Diopter adjustment range	+/-4 dpt.		+/-3 dpt.		+/-4 dpt.	
Exit pupil distance	18 mm		16 mm		15.5 mm	15.2 mm
Interpupillary distance (PD)	55–76 mm		58–76 mm		52–74 mm	
Objective type	Ultra-FL		FL/HT-Type		FL	
Prism system	Schmidt-Pechan		Abbe-König		Schmidt-Pechan	
Coating	LotuTec®/T*		LotuTec®/T*		LotuTec®/T*	
Nitrogen filled	yes		yes		yes	
Water resistance	400 mbar		500 mbar		400 mbar	
Operating temperature	-30/+63°C		-30/+63°C		-30/+63°C	
Length	173 mm		193 mm		117 mm	
Width at an interpupillary distance of 65 mm	125 mm		142 mm		116 mm	
Weight	780 g		1,035 g	1,050 g	550 g	560 g
Order number	52 42 23	52 42 24	52 56 28	52 56 29	52 32 30	52 32 31

Subject to changes in design and scope of delivery as a result of ongoing technical development. For more information, please visit www.zeiss.com/sports-optics

Victory binoculars Model	Pocket	
	8×25	10×25
Magnification	8×	10×
Effective lens diameter	25 mm	25 mm
Exit pupil diameter	3.1 mm	2.5 mm
Twilight factor	14.1	15.8
Field of view at 1,000 m	130 m	105 m
Subjective viewing angle	60°	
Close focus	1.9 m	
Diopter adjustment range	+/-3 dpt	
Exit pupil distance	16.5 mm	
Pupil distance	34–74 mm	
Lens type	FL	
Prism system	Schmidt-Pechan	
LotuTec® / nitrogen filled	yes/yes	
Water resistance	100 mbar	
Operating temperature	-25/+63°C	
Length	112 mm	
Width at an interpupillary distance of 65 mm	100 mm	
Weight	290 g	
Order number	52 20 38	52 20 39

Subject to changes in design and scope of delivery as a result of ongoing technical development.

Conquest binoculars Model	HD						
	8×32	10×32	8×42	10×42	8×56	10×56	15×56
Magnification	8×	10×	8×	10×	8×	10×	15×
Effective lens diameter	32 mm	32 mm	42 mm	42 mm	56 mm	56 mm	56 mm
Exit pupil diameter	4 mm	3.2 mm	5.25 mm	4.2 mm	7 mm	5.6 mm	3.7 mm
Twilight factor	16	17.9	18.3	20.5	21.2	23.7	29.0
Field of view at 1,000 m	140 m	118 m	128 m	115 m	125 m	115 m	80 m
Subjective viewing angle	64° Ww	68° Ww	59°	66° Ww	57°	66° Ww	69° Ww
Close focus	1.5 m		2 m		3.5 m		
Diopter adjustment range	+/-4 dpt		+/-4 dpt		+/-4 dpt		
Exit pupil distance	16 mm		18 mm		18 mm		
Pupil distance	54–74 mm		54–74 mm		54–74 mm		
Lens type	HD		HD		HD		
Prism system	Schmidt-Pechan		Schmidt-Pechan		Abbe-König		
Coating	LotuTec®/T*		LotuTec®/T*		LotuTec®/T*		
Nitrogen filled	yes		yes		yes		
Water resistance	400 mbar		400 mbar		400 mbar		
Functional temperature	-20/+63°C		-20/+63°C		-20/+63°C		
Length	132 mm		150 mm		210 mm		
Width at an interpupillary distance of 65 mm	118 mm		120 mm		145 mm		
Weight	630 g	630 g	795 g	795 g	1,265 g	1,275 g	1,295 g
Order number	52 32 11	52 32 12	52 42 11	52 42 12	52 56 31	52 56 32	52 56 33

Subject to changes in design and scope of delivery as a result of ongoing technical development.

Terra binoculars Model	ED					
	8×25	10×25	8×32	10×32	8×42	10×42
Magnification	8×	10×	8×	10×	8×	10×
Effective lens diameter	25 mm		32 mm		42 mm	
Exit pupil diameter	3.1 mm	2.5 mm	4.0 mm	3.2 mm	5.3 mm	4.2 mm
Twilight factor	14.1	15.8	16.0	17.9	18.3	20.5
Field of view at 1,000 m	119 m	97 m	135 m	112 m	125 m	110 m
Subjective angle of view	52°	54°	61°	61°	56°	60°
Close-up setting limit	1.9 m		1.6 m		1.6 m	
Diopter adjustment range	+/-3 dpt		+/-3 dpt		+/-3 dpt	
Exit pupil distance	16 mm		16.5 mm		18 mm	15 mm
Pupil distance	35–72 mm		56–74 mm		58–75.5 mm	
Lens type	ED		ED		ED	
Prism system	Schmidt-Pechan		Schmidt-Pechan		Schmidt-Pechan	
Coating	Hydrophobic ZEISS mC		Hydrophobic ZEISS mC		Hydrophobic ZEISS mC	
Nitrogen filled	yes		yes		yes	
Water resistance	100 mbar		100 mbar		100 mbar	
Operating temperature	-20/+63°C		-15/+60°C		-15/+60°C	
Length	111 mm		125 mm		142 mm	
Width with an eye spacing of 65 mm	115 mm		117 mm		120 mm	
Weight	310 g		510 g		725 g	
Order number	black/green		52 32 03-99 08	52 32 04-99 08	52 42 03-99 08	52 42 04-99 08
	black/black		52 32 03-99 01	52 32 04-99 01	52 42 03-99 01	52 42 04-99 01
	grey/grey		52 25 02-99 07	52 25 03-99 07	52 32 03-99 07	52 32 04-99 07

Subject to changes in design and scope of delivery as a result of ongoing technical development.

Model	Monos					
	3 × 12	4 × 12	6 × 18	8 × 20	10 × 25	MiniQuick® 5 × 10
Magnification	3 ×	4 ×	6 ×	8 ×	10 ×	5 ×
Lens diameter	12 mm		18 mm	20 mm	25 mm	10 mm
Exit pupil diameter	4 mm	3 mm		2.5 mm		2 mm
Twilight factor	6	6.9	10.4	12.6	15.8	7
Field of view at 1,000 m	220 m	180 m	120 m	110 m	88 m	100 m
Subjective viewing angle	38°	41°		51°		29°
Close focus	0.2 m	0.25 m	0.3 m	3 m	4.5 m	4 m
Diopter adjustment range	+/- 4 dpt					
Eye relief	12 mm	15 mm			16.5 mm	
Lens type	Achromat					
Prism system	Schmidt-Pechan					–
Water resistance	splash proof					
Functional temperature range	-20 / +40 °C					
Height × width	58 mm	70 mm	94 mm	101 mm	119 mm	113 mm
Weight	54 g	45 g	58 g	67 g	77 g	23 g
Order number	52 20 12	52 20 50	52 20 51	52 20 52	52 20 53	52 20 10

All with ZEISS T*-multi-layer coating.
Subject to changes in design and scope of delivery as a result of ongoing technical development.

Model	Binoculars with image stabilisation
	20 × 60 S
Magnification	20 ×
Lens diameter	60 mm
Exit pupil diameter	3 mm
Twilight factor	34.6
Field of view at 1,000 m	Ww 52 m
Subjective viewing angle	60°
Close focus	14 m
Diopter adjustment range	+/- 7 dpt
Eye relief	13 mm
Pupil distance	57 – 73 mm
Lens type	Achromat
Prism system	Porro
Water resistance	splash proof
Functional temperature range	-20 / +40 °C
Height × width	275 × 161 mm
Weight	1,660 g
Order number	52 60 00

Delivery including neoprene carrying strap, eyepiece cover, aluminium case.
Subject to changes in design and scope of delivery as a result of ongoing technical development.

Model	Night Vision
	5.6 × 62 NV
Magnification	5.6 ×
Lens diameter	62 mm
Field of view at 1,000 m	142 m
Close focus	5 m
Diopter adjustment range	+/- 4 dpt
Eye relief	20 mm
LotuTec®	yes
Nitrogen filling	yes
Length × height × width	233 × 100 × 80 mm
Weight	ca. 1,000 g
Reticle: distance between lines	0.5 m / 100 m
Measuring range	500 m
Order number	52 30 07-9901

Delivery including cordura pouch, carrying strap, eyepiece and lens covers and 2 × AA batteries.
Subject to changes in design and scope of delivery as a result of ongoing technical development.



QUALITY DEMANDED AROUND THE GLOBE: ZEISS SPOTTING SCOPES

Victory Spotting Scope Model	Harpia	
	85	95
Focal length of lens	162 mm – 486 mm	174 mm – 523 mm
Filter thread objective lens side	M86 × 1	M95 × 1
Lens diameter	85 mm	95 mm
Close focus	3.5 m	4.5 m
Height × width × length	121 × 103 × 384 mm	124 × 109 × 408 mm
Weight without eyepiece	1,934 g	2,078 g
Waterproof	400 mbar	
Nitrogen filling	yes	
Order number	52 80 47	52 80 57

Model	Eyepiece	
	22 – 65 ×	23 – 70 ×
Focal length	7.48 mm	
Field of view m / 1,000 m	63.2 – 21.0	58.8 – 19.5
Zoom factor	3 ×	
Exit pupil	2.50 – 1.31 mm	2.50 – 1.34 mm
Diameter	Ø 53 mm	
Length	71 mm	
Weight	220 g	
Order number	52 80 70	

Including eyepiece and lens cover. All with ZEISS T*-multi-layer-coating.

Model	Dialyt Spotting Scope
	18 – 45 × 65
Magnification	18 – 45 ×
Lens diameter	65 mm
Exit pupil diameter	3.6 – 1.4 mm
Field of view at 1,000 m	40 – 23 m
Close focus	10 m
Lens type	Achromat
Nitrogen filling	yes
Water resistance	400 mbar
Length × height × width	395 × 78 × 76 mm
Weight	ca. 1,195 g
Order number	52 80 07

Including eyepiece and lens cover, carrying strap.

Subject to changes in design and scope of delivery as a result of ongoing technical development.

Model	Gavia 85
Magnification	30 – 60 ×
Lens diameter	85 mm
Exit pupil diameter	2.8 mm – 1.4 mm
Focal length	494 mm
Field of view at 1,000 m	33 m – 23 m
Close focus	3.3 m
Lens type	HD
LotuTec® / Nitrogen filling	yes / yes
Water resistance	400 mbar
Lens thread	M86 × 1
Length	396 mm
Weight (incl. eyepiece)	ca. 1,700 g
Order number (incl. eyepiece 30 – 60 × 85)	52 80 48-0000-000

Including eyepiece and lens cover.

Adapter	Order number
Astro adapter	52 83 45
Photo lens adapter m49	52 83 48-9901
Photo lens adapter m52	52 83 48-9902
Photo lens adapter m58	52 83 48-9903
ExoLens bracket adapter	52 83 61-9901

NUMEROUS OPTIONS: ZEISS ACCESSORIES

Model	ExoLens bracket adaptor for
Conquest Gavia	52 83 61-9901
Victory Harpia	52 83 62-9901
Victory SF	52 83 60-9901
Victory HT	52 83 60-9902
Conquest 32/42 HD	52 83 60-9903
Conquest 56 HD	52 83 60-9904
Terra ED	52 83 60-9905
DiaScope Vario-Ocular 15 – 56 × / 20 – 75 ×	52 83 60-9906
DiaScope Vario-Ocular 20 – 60 × / 15 – 45 ×	52 83 60-9907

Model	Tripods	Long balance plate
	Professional	
Material	Carbon	for model Professional only
Length closed	ca. 700 mm	
Length open	ca. 1,820 mm	
Weight	ca. 2,460 g	
Order number	21 69-972	

Model	Astro adapter
for standard astro eyepieces	52 83 85
for 1¼" astronomy telescopes	52 83 86
Astro adapter for DiaScope	52 83 82

Subject to changes in design and scope of delivery as a result of ongoing technical development.

Model	ExoLens Bracket for
Apple iPhone 6/6s	21 86-887
Apple iPhone 7/8	22 16-613
Samsung Galaxy S6/S6 edge	21 88-170

Model	Carrying case for
DiaScope 65 FL straight view	1778-946
DiaScope 65 FL angled view	1778-968
DiaScope 85 FL straight view	1778-973
DiaScope 85 FL angled view	1778-974
Conquest Gavia 85	2169-979
Victory Harpia 85	2169-976
Victory Harpia 95	2169-977

TECHNICAL SPECIFICATIONS

WITH PRECISION IN MIND: ZEISS ACCESSORIES

Bullet drop compensators BDC (ASV) Order no.

BDC (ASV) LongRange (LR) for Victory V8
1.8–14×50, 2.8–20×56
for elevation with new orders -040

for elevation and windage with new orders -050

BDC (ASV) Competition for Victory V8
4.8–35×60 for lateral with new orders -050

BDC+ (ASV+) for Victory HT
for elevation with new orders -010

for elevation and windage with new orders -020

BDC (ASV) V6 for Conquest V6
for elevation with new orders -060

Throw lever Order no.

for Conquest V4 2248-168

for Conquest V6 2224-899

Flip cover for Victory V8 /Victory HT Order no.

Ø 30 mm 2152-898

Ø 50 mm 2105-737

Ø 56 mm 2105-798

Ø 60 mm 2173-926

Neoprene cover Order no.

for Victory V8/Victory HT Ø 50 mm 1447-655

for Victory V8/Victory HT Ø 56 mm 1392-256

for Victory V8 Ø 60 mm 2175-139

Rubber light shield (not for V8) 52 83 75

Battery cover

for spare battery (battery container) 52 16 24-8009



Protective cap for riflescopes

please state the exact model

Elevation cap

please state the exact model

TECHNICAL SPECIFICATIONS

IMPROVED PERFORMANCE: ZEISS ACCESSORIES

Tripod adapter Order no.

Binofix universal tripod mount
for all binocular models 52 83 87

Tripod adaptor ¼" for Conquest HD
(included in HD 15×56 delivery) 52 83 88

Magnification attachment Mono 3×12 Order no.

Including carrying strap and leather pouch;
triples normal binocular magnification 52 20 12

Adaptor for magnification attachment Order no.

SLR camera adapter (see picture) 52 83 77

1" flashlight mount 52 83 79

Min Maglite adapter 52 83 83

Accessories for Victory NV 5.6×62 Order no.

SLR camera adapter (see picture) 52 30 06-9007

1"-flashlight mount 52 30 06-9006

Min Maglite adapter 52 30 06-9008

Pouches Order no.

for Victory SF 2060-069

for Terra Pocket 2197-806

Leather pouch for 20×60 S 52 90 83

Cordura bags Order no.

for Victory HT 42 1980-766

for Victory HT 54 2074-447

for Conquest HD 32 and Terra ED 32 52 90 35

for Conquest HD 42 and Terra ED 42 1976-008

for Conquest HD 56 1379-711

Carrying straps Order no.

Air Cell comfort straps 52 91 13

Binocular comfort straps 52 91 15



Binofix universal tripod mount



Tripod adaptor 1/4"



Magnification attachment Mono 3×12



Adaptor for magnification attachment



SLR camera adaptor



Pouch for Victory SF



Cordura bag



Pouch for Terra Pocket



Air Cell comfort straps



Binocular comfort straps



Join the **ZEISS Hunting Community**.

Follow us online:



facebook.com/ZEISSHunting



zeiss.com/hunting-blog



youtube.com/user/zeissportsoptics



[#passionforhunting](https://twitter.com/#passionforhunting)

Customer Service

Carl Zeiss Sports Optics GmbH – Customer Service
Gloelstrasse 3–5, 35576 Wetzlar, Germany
Phone +49 (0)6441 467 61 | Fax +49 (0)6441 483 69
service.sportsoptics@zeiss.com

Carl Zeiss Sports Optics GmbH

ZEISS Group
Business Group
Consumer Products
Gloelstrasse 3–5
35576 Wetzlar
Germany

www.zeiss.com/sports-optics

