



TWENTY EIGHTEEN

Revised July 10, 2018

RIFLESCOPES

BLACK FX1000. 4-5
BLACK X1000 6-7
BLACK FORCE1000 10-11
M-TACTICAL/P-TACTICAL 12-17
P-TACTICAL SPUR/SUPERDOT 18-19
MONARCH 7-5-3. 20-23
PROSTAFF 7-5 & PROSTAFF 24-27
NEW PROSTAFF P3 PREDATOR HUNTER. 29
NEW PROSTAFF P3 MUZZLELOADER 30
NEW PROSTAFF P3 SHOTGUN 31
BUCKMASTERS 32
HANDGUN/**NEW** PROSTAFF P3 CROSSBOW 33
RIMFIRE 34-35
NEW PROSTAFF P3 TARGET EFR. 35

LASER RANGEFINDERS

MONARCH 3000 STABILIZED 38
BLACK RANGEX 4K 8-9, 39
LASERFORCE RANGEFINDER BINOCULAR 40-41
PROSTAFF/ACULON/BOWHUNTING 42-43

BINOCULARS

MONARCH HG-7-5 44-49
NEW MONARCH HG 30mm. 48
PROSTAFF 7S-5-3S 50-51
ACULON. 52-53
SPECIALTY. 54-57

FIELDSCOPES

MONARCH 60-61
FIELDSCOPE 50MM ED. 61
PROSTAFF. 62-63

SCOPE MOUNTING SOLUTIONS

. 64-65

ACCESSORIES

. 66-67

BALLISTIC TECHNOLOGIES

. 68-69

RIFLESCOPE RETICLE SUBTENSIONS

. 70-73



**LIFETIME
REPAIR/REPLACEMENT**

Excludes lost or stolen products and intentionally caused damage, and also excludes Nikon Rangefinders, Reflex Sights, Red Dot Sights, StabilEyes Binoculars & Specialty Optics.

BLACK

A person in tactical gear, including a helmet and a camouflage cap, is lying prone and aiming a rifle with a scope. The rifle is mounted on a tripod. The person is wearing a grey t-shirt and a watch. The background is dark and textured, possibly a wall or a large piece of equipment.

UNDENIABLE PRECISION.

What do you get when you dedicate a century to building some of the finest optics on the planet to satisfy the needs and desires of the most critical users? BLACK—Nikon's flagship family of tactical optics. The proving ground for thousands of engineering hours focused on bringing painstakingly precise, highly innovative products to the hands and eyes of shooters, BLACK brings a new level of performance—and expectation—to the tactical optics world. For 2018, Nikon delivers on these expectations with the introduction of first focal plane precision riflescopes and extreme distance capable laser rangefinders.



BLACK FX1000

MATCH GRADE FFP OPTIC

Engineered to deliver your longest shots with confident precision, the new BLACK FX1000 is set to raise eyebrows and expectations among long-range shooters. Competition-ready straight from the box, BLACK FX1000 integrates renowned Nikon optics into its first focal plane optical system for tack-sharp images and dialing functionality at any magnification and distance. Proprietary new glass-etched tactical reticles paired with precise, high-speed turrets allow fast, repeatable distance corrections and intuitive hold-off points. The BLACK FX1000 also debuts Nikon's all-new BLACK Return-to-Zero integral zero-stop in the elevation turret. Sunshade included.



GENEROUS, CONSISTENT EYE RELIEF
Keeps your brow safe.

FULLY MULTICOATED OPTICS
Multiple layers of anti-reflective coating on all air-to-glass surfaces maximize light transmission, brightness and contrast.

4x ZOOM RATIO
Offers maximum magnification versatility.

30mm MAIN BODY TUBE
Constructed of aircraft-grade aluminum with Type-III hard anodizing for maximum strength-to-weight ratio and optimum ruggedness.

HEAVY RECOIL RESISTANT
Built to withstand the recoil of the hardest-hitting calibers.



Integral Zero Stop
BLACK FX1000 features an all-new return-to-zero stop for rapid return to zero.



High-Speed Windage & Elevation Turrets
Exposed turrets engraved for maximum readability while offering smooth, repeatable adjustments. High speed travel turrets deliver 10 MRAD / 25 MOA per rotation.

GLASS-ETCHED RETICLE
Extremely durable, yet fine and detailed reticle design that maintains color and contrast in all light conditions.

SHOCKPROOF CONSTRUCTION
Shrugs off hard recoil and rugged use.

WATERPROOF
O-ring sealed to prevent moisture from entering body.

FOGPROOF
Nitrogen purged for total reliability against thermal shock.

HIGH SPEED TURRETS
25 MOA / 10 MRAD travel per rotation.

DIRECTIONAL INDICATORS
Clearly marked on windage and elevation turrets.

RETURN-TO-ZERO STOP
Proprietary design is easy to set up and retains your zero point until you change it.

SIDE FOCUS PARALLAX ADJUSTMENT
Side Parallax knob allows adjustment without changing shooting position.

10-LEVEL RHEOSTAT
On illuminated reticle models.

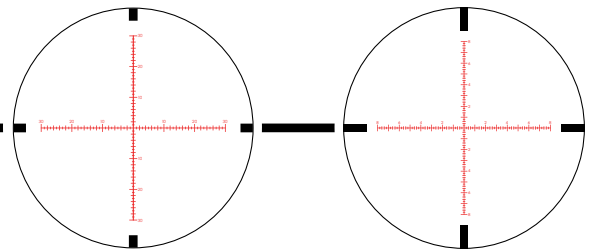

FX-MOA

ILLUMINATION SHOWN

FX-MRAD

BLACK FX Reticles

Nikon's proprietary FX-MOA and FX-MRAD reticles were created expressly for the first focal plane optical system used in the BLACK FX1000 rifle scope. Each reticle is designed to optimize the sight picture and provide the tools necessary for ranging, holdover and windage corrections. Illuminated reticle models with side-mounted control offer 10 intensity levels of red illumination with OFF switch between each step for quick, easy brightness adjustments.



BLACK Precision & Cantilever 30mm Mounts Available

See page 62 for more information

BLACK FX1000

	ILL	RETICLE	WEIGHT (OZ)	LENGTH (IN)	EYE RELIEF (IN)	FOV-FT @ 100 YDS	ADJUST GRAD	MAX INTERNAL ADJUST	TRAVEL PER ROTATION	PARALLAX (YDS)	SRP
16511	4-16x50SF Matte	FX-MOA	23.3	14.8	4-3.6	27.2-6.8	1/4 MOA	90 MOA	25 MOA	50-INFINITY	\$649.95
16512	4-16x50SF Matte	FX-MRAD	23.3	14.8	4-3.6	27.2-6.8	0.1 MRAD	25 MRAD	10 MRAD	50-INFINITY	\$649.95
16513	4-16x50SF Matte	✓ FX-MOA	23.8	14.8	4-3.6	27.2-6.8	1/4 MOA	90 MOA	25 MOA	50-INFINITY	\$749.95
16514	4-16x50SF Matte	✓ FX-MRAD	23.8	14.8	4-3.6	27.2-6.8	0.1 MRAD	25 MRAD	10 MRAD	50-INFINITY	\$749.95
16515	6-24x50SF Matte	✓ FX-MOA	24.5	15.2	4-3.5	18.0-4.7	1/4 MOA	60 MOA	25 MOA	50-INFINITY	\$799.95
16516	6-24x50SF Matte	✓ FX-MRAD	24.5	15.2	4-3.5	18.0-4.7	0.1 MRAD	17 MRAD	10 MRAD	50-INFINITY	\$799.95

BLACK Precision Mounts (30mm)

16404	BLACK Precision 1-piece (MSR)	\$139.95
16406	BLACK Precision 1-piece (Medium)	\$139.95

BLACK Cantilever Mounts (30mm)

16403	BLACK Cantilever	\$139.95
16405	BLACK Cantilever (20 MOA Cant)	\$139.95



BLACK X1000



FOCUSED ON PRECISION

Enhanced optical performance, extreme durability and confidence-building mechanical precision are core values used to develop the BLACK X1000 precision long-range riflescope. Featuring tactical-style reticles, BLACK X1000 presents the shooter with highly functional and advanced tools for estimating range or maintaining holdovers. Sunshade included.



- GENEROUS, CONSISTENT EYE RELIEF**
Keeps your brow safe.
- QUICK FOCUS EYEPIECE**
Smooth-turn aluminum ring with rubberized eye guard allows crisp reticle focus and quick target acquisition.
- 4x ZOOM RATIO**
Offers maximum magnification versatility.
- GLASS-ETCHED RETICLE**
Extremely durable, yet fine and detailed reticle design that maintains color and contrast in all light conditions.
- WATERPROOF**
O-ring sealed to prevent moisture from entering body.
- FOGPROOF**
Nitrogen purged for total reliability against thermal shock.
- SHOCKPROOF CONSTRUCTION**
Shrugs off hard recoil and rugged use.

- 30mm MAIN BODY TUBE**
Constructed of aircraft-grade aluminum with Type-III hard anodizing for maximum strength-to-weight ratio and optimum ruggedness.
- HEAVY RECOIL RESISTANT**
Built to withstand the recoil of the hardest-hitting calibers.
- FULLY MULTICOATED OPTICS**
Multiple layers of anti-reflective coating on all air-to-glass surfaces maximize light transmission, brightness and contrast.

- SPRING-LOADED INSTANT ZERO-RESET TURRETS**
Spring-loaded Windage and Elevation knobs can be reset to "zero" after sighting-in for easy reference when making field adjustments.
- DIRECTIONAL INDICATORS**
Clearly marked on windage and elevation turrets.
- SIDE FOCUS PARALLAX ADJUSTMENT**
Side Parallax knob allows adjustment without changing shooting position.
- 10-LEVEL RHEOSTAT**
On illuminated reticle models.



Elevated Windage & Elevation Turrets
Exposed turrets engraved for maximum readability. Internal travel is enhanced for long-range dialing. Crisp, click-stop movements for no backlash.

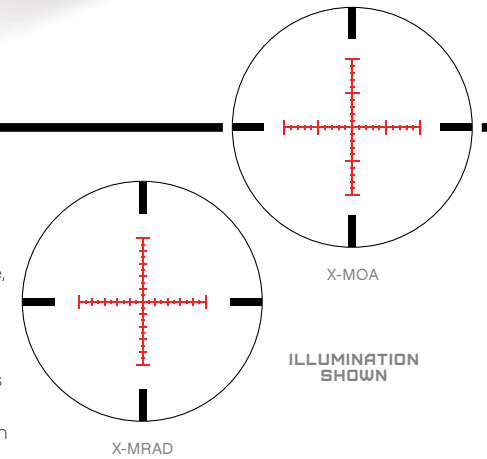

BLACK X-MOA and X-MRAD Reticles
Nikon's X-MOA and X-MRAD reticles present the shooter with clean and visually simple, yet highly functional and advanced tools for estimating range, maintaining holdovers or dialing elevation come ups and compensating for wind. Illuminated reticle models with side-mounted control offer 10 intensity levels of red illumination with OFF switch between each step for quick, easy brightness adjustments.

BLACK X1000		ILL	RETICLE	WEIGHT (OZ)	LENGTH (IN)	EYE RELIEF (IN)	FOV-FT @ 100 YDS	ADJUST GRAD	MAX INTERNAL ADJUST	TRAVEL PER ROTATION	PARALLAX (YDS)	SRP
16381	4-16x50SF Matte		X-MOA	23.8	14.8	4-3.6	27.2-6.8	1/4 MOA	90 MOA	12 MOA	50-INFINITY	\$499.95
16382	4-16x50SF Matte	✓	X-MOA	24.3	14.8	4-3.6	27.2-6.8	1/4 MOA	90 MOA	12 MOA	50-INFINITY	\$599.95
16383	4-16x50SF Matte	✓	X-MRAD	24.3	14.8	4-3.6	27.2-6.8	0.1 MRAD	25 MRAD	5 MRAD	50-INFINITY	\$599.95
16423	6-24x50SF Matte	✓	X-MOA	25	15.2	4-3.5	18.0-4.5	1/4 MOA	60 MOA	12 MOA	50-INFINITY	\$649.95
16384	6-24x50SF Matte	✓	X-MRAD	25	15.2	4-3.5	18.0-4.5	0.1 MRAD	17 MRAD	5 MRAD	50-INFINITY	\$649.95

BLACK Precision Mounts (30mm)		
16404	BLACK Precision 1-piece (MSR)	\$139.95
16406	BLACK Precision 1-piece (Medium)	\$139.95

BLACK Cantilever Mounts (30mm)		
16403	BLACK Cantilever	\$139.95
16405	BLACK Cantilever (20 MOA Cant)	\$139.95

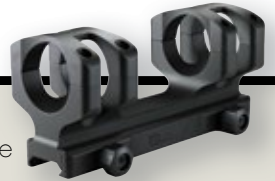

BLACK Precision & Cantilever 30mm Mounts Available

See page 62 for more information



BLACK RANGEX 4K

BUILT FOR THE EXTREMES

Working out the solution for a crucial shot means you need an accurate range right now, regardless of the distance. Nikon's new BLACK RANGEX 4K is engineered to deliver over 2 miles of ranging capability with the speed, precision and consistency you need for extreme long-distance shooting. Featuring Nikon's HYPER READ for extraordinarily fast, positive measurements, the rangefinder's integral monocular offers the bright, sharp view required for target spotting and acquisition. BLACK RANGEX 4K's high-visibility red OLED display provides ideal contrast on distant targets with automatic or five stages of selectable brightness. The BLACK RANGEX 4K is also equipped with Nikon's ID Technology that delivers the one number you need for determining your best shot, regardless of shooting angle.

4,000 YARD MEASUREMENT RANGE

Maximum measurement distance*
Reflective Target - 4,000 yards
Maximum measurement distance*
Tree - 1,700 yards
Maximum measurement distance*
Deer - 1,500 yards

8-SECOND SUSTAINED MEASUREMENT

Continuously measure single or across multiple targets.

Tru-Target Technology enables you to choose between two different ranging modes, depending on the situation.

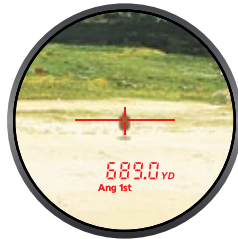

First Target Priority Mode

Provides the exact distance to the closest object among a group of targets being measured. In this mode, you can easily range an object as small as a fence post.

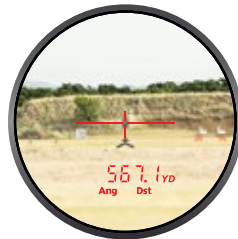

Distant Target Priority Mode

Displays the range of the farthest target among a group of targets measured. This feature is especially useful if the subject is located behind tall grass or brush.

OLED DISPLAY

High visibility red display provides ideal contrast on distant targets.

HYPER READ

Laser provides quick and stable measurement response regardless of distance (approx. 0.3 seconds).



WATERPROOF

O-ring sealed to prevent moisture from entering body.

FOGPROOF

Nitrogen purged for total reliability against thermal shock.

FULLY MULTICOATED OPTICS

Multiple layers of anti-reflective coating on all air-to-glass surfaces maximize light transmission, brightness and contrast.

6x MONOCULAR

Fully multicoated optics provide bright clear view of target.

ID TECHNOLOGY

Delivers the one number you need for your best shot to account for incline or decline shooting angles.

5-YEAR WARRANTY

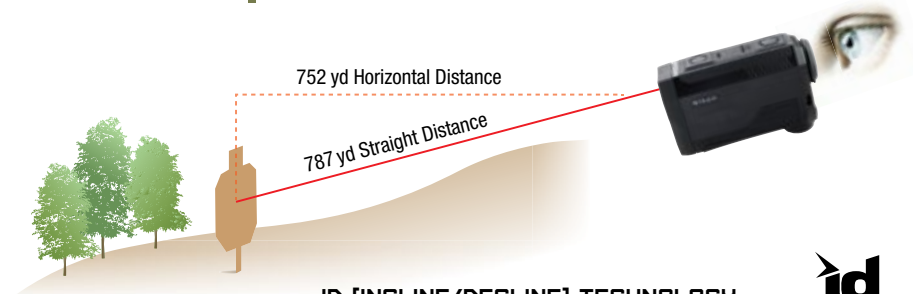

ID [INCLINE/DECLINE] TECHNOLOGY



Nikon's advanced ID [Incline/Decline] Technology provides the horizontal distance to the target, even when ranging at various incline or decline shooting angles—up to an incredible +/- 89 degrees [nearly vertical up or down].

BLACK RANGEX 4K	MAG. OBJ DIA.	EYE RELIEF (MM)	REAL ANGULAR FOV (DEGREES)	FOV @ 1000 YARDS (FT)	MAX RANGE (REFLECTIVE)*(YDS)	MAX RANGE (TREE)*(YDS)	MAX RANGE (DEER)*(YDS)	WEIGHT (W/O BATTERIES) (OZ)	SIZE (LxHxW) (IN)	SRP
16557	6x21	18.3	7.5	39.3	4,000	1,700	1,500	6.3	4.3x2.9x1.6	\$449.95

*Reference value. Under Nikon's measurement conditions.

The specifications of the product may not be achieved depending on the target object's shape, surface texture and nature, and/or weather conditions.

The technology behind the Laser Rangefinder with inclinometer originated from technology incorporated in Nikon's Total Station DTM-1 surveying instrument. The Total Station DTM-1, first sold in 1985, was the first highly advanced electronic model of those surveying instruments that incorporated a distance and angle measuring capability developed by Nikon Corporation.



BLACK FORCE1000

ACCELERATED PRECISION

Nikon's BLACK FORCE1000 riflescope delivers extreme targeting speed, repeatable precision and superior accuracy for your MSR platform. Designed for both-eyes-open engagement as well as aiming precision for extended ranges, this compact optic's rugged construction and metal-capped turrets assure extreme durability and sighting confidence under tough conditions.



QUICK FOCUS EYEPIECE
Smooth-turn aluminum ring with rubberized eye guard allows crisp reticle focus and quick target acquisition.

1x MAGNIFICATION
For both-eyes-open engagement.

4x ZOOM RATIO
Offers maximum magnification versatility.

GLASS-ETCHED RETICLE
Extremely durable, yet fine and detailed reticle design that maintains color and contrast in all light conditions.

WATERPROOF
O-ring sealed to prevent moisture from entering body.

FOGPROOF
Nitrogen purged for total reliability against thermal shock.

SHOCKPROOF CONSTRUCTION
Shrugs off hard recoil and rugged use.

HEAVY RECOIL RESISTANT
Built to withstand the recoil of the hardest-hitting calibers.

FULLY MULTICOATED OPTICS
Multiple layers of anti-reflective coating on all air-to-glass surfaces maximize light transmission, brightness and contrast.

GENEROUS, CONSISTENT EYE RELIEF
Keeps your brow safe.

SPRING-LOADED INSTANT ZERO-RESET TURRETS
Spring-loaded Windage and Elevation knobs can be reset to "zero" after sighting-in for easy reference when making field adjustments.

10-LEVEL RHEOSTAT
On illuminated reticle models.

30mm MAIN BODY TUBE
Constructed of aircraft-grade aluminum with Type-III hard anodizing for maximum strength-to-weight ratio and optimum ruggedness.



Side-Mounted Illumination Control

Illuminated reticle with side-mounted control offers 10 intensity levels of red illumination with OFF switch between each step for quick, easy brightness adjustments. Auto shutoff after one hour of non-operation.

SPEEDFORCE reticle

The SPEEDFORCE reticle was designed for both reaction-speed target acquisition and engagement, and for intermediate-range target holdovers using BDC circles and hash marks. The SPEEDFORCE is an MOA subtension reticle engineered to enable you to continue momentum from target to target and thus, excel in close-to-medium range engagements both in competition and field use. When the rifle scope is set at its lowest 1x magnification, the reticle's illuminated double horseshoe serves as quick reference for centering on the target with both eyes open, as well as for establishing moving-target leads.

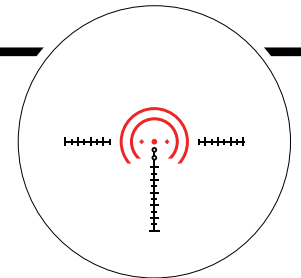

SPEEDFORCE
ILLUMINATION SHOWN

BLACK FORCE1000	ILL	RETICLE	WEIGHT (OZ)	LENGTH (IN)	EYE RELIEF (IN)	FOV-FT @ 100 YDS	ADJUST GRAD	MAX INTERNAL ADJUST	TRAVEL PER ROTATION	PARALLAX (YDS)	SRP
16380	1-4x24 Matte	✓ SPEEDFORCE	16.4	10.5	4.1-3.8	110.1-27.2	1/2 MOA	350 MOA	24 MOA	100	\$399.95
BLACK Cantilever Mounts (30mm)											
16403	BLACK Cantilever										\$139.95
16405	BLACK Cantilever (20 MOA Cant)										\$139.95
BLACK Precision Mounts (30mm)											
16404	BLACK Precision 1-piece (MSR)										\$139.95
16406	BLACK Precision 1-piece (Medium)										\$139.95

BLACK Precision & Cantilever 30mm Mounts Available

See page 62 for more information







TACTICAL



TACTICAL



M-TACTICAL & P-TACTICAL

2018 marks the re-birth of an iconic Nikon family of products, bringing the range of M-Series and P-Series optics full circle. Introducing M-TACTICAL and P-TACTICAL, a new family of optics created with the performance features shooters need, and the choices they want. Like matched reticles/turrets with MOA and MRAD options or caliber-designated BDC reticles. 30mm or one-inch tubes. 3x or 4x zoom ratios. These and other distinguishing factors help you choose the right optic for your rifle. With confidence in knowing M-TACTICAL and P-TACTICAL will deliver the optical quality, repeatable mechanical precision and ruggedness that you can count on for life.



BIGGER, BOLDER PERFORMANCE

For 2018, the all-new M-TACTICAL ratchets up riflescope performance through a profound mix of optical design, superior glass, innovative materials and 100 years of Nikon optical ingenuity. The proprietary glass and multicoating technology used in these optics prioritizes bright, high contrast sight pictures—and those views are complemented by purpose-driven reticles designed for long range. Highly innovative and intuitive MK1-MOA and MK1-MRAD tactical reticles with matched turrets are the ticket for dialing-in your longest shot with speed and precision. When platform-focused ballistic technology is desired, the M-TACTICAL lineup's caliber-designated reticles and Spot On ballistics are engineered to put the most challenging distances within reach. All long-range M-TACTICAL models feature side-focus parallax adjustments, while the full range of models feature directional indicators on turrets, 4x zoom ratio and utilize robust 30mm main body tubes drawn from aircraft-grade aluminum alloy. Turrets and zoom rings have knurling that is ergonomically designed for comfortable function with virtually any finger size. Each M-TACTICAL riflescope is finished with ultra-matte anodizing for extreme durability and reliability during a lifetime of real world performance.



GENEROUS, CONSISTENT EYE RELIEF

Keeps your brow safe.

QUICK FOCUS EYEPiece

Smooth-turn aluminum ring with rubberized eye guard allows crisp reticle focus and quick target acquisition.

4x ZOOM RATIO

Offers maximum magnification versatility.

WATERPROOF

O-ring sealed to prevent moisture from entering body.

FOGPROOF

Nitrogen purged for total reliability against thermal shock.

SHOCKPROOF CONSTRUCTION

Shrugs off hard recoil and rugged use.

FULLY MULTICOATED OPTICS

Multiple layers of anti-reflective coating on all air-to-glass surfaces maximize light transmission, brightness and contrast.

SPRING-LOADED INSTANT ZERO-RESET TURRET

Spring-loaded Windage and Elevation knobs can be reset to "zero" after sighting-in for easy reference when making field adjustments.

DIRECTIONAL INDICATORS

Clearly marked on windage and elevation turrets.

SIDE FOCUS PARALLAX ADJUSTMENT

Side Parallax knob allows adjustment without changing shooting position.

30mm MAIN BODY TUBE

Constructed of aircraft-grade aluminum with Type-III hard anodizing for maximum strength-to-weight ratio and optimum ruggedness.



Exposed Turrets with Coarse Knurling feature positive-click reticle adjustments to get you zeroed in quick and maintain your setting, even with heavy recoil.

M-TACTICAL

	RETICLE	WEIGHT (OZ)	LENGTH (IN)	EYE RELIEF (IN)	FOV @ 100 YDS	ADJUST GRAD	MAX INTERNAL ADJUST	TRAVEL PER ROTATION	PARALLAX (YDS)	SRP	
16521	1-4x24 Matte	MK1-MOA	16.4	10.4	3.8-3.7	118.8-29.9	1/2 MOA	220 MOA	40 MOA	100	\$249.95
16519	3-12x42SF Matte	MK1-MOA	20.5	13.1	3.9-3.6	37.2-9.4	1/4 MOA	75 MOA	20 MOA	50-INFINITY	\$399.95
16520	3-12x42SF Matte	MK1-MRAD	20.5	13.1	3.9-3.6	37.2-9.4	0.1 MRAD	15 MRAD	8 MRAD	50-INFINITY	\$399.95

M-TACTICAL .308

16517	4-16x42SF Matte	BDC 800	20.6	13.6	3.9-3.6	27.8-6.8	1/4 MOA	55 MOA	20 MOA	50-INFINITY	\$449.95
-------	-----------------	---------	------	------	---------	----------	---------	--------	--------	-------------	----------

M-TACTICAL .223

16518	4-16x42SF Matte	BDC 600	20.6	13.6	3.9-3.6	27.8-6.8	1/4 MOA	55 MOA	20 MOA	50-INFINITY	\$449.95
-------	-----------------	---------	------	------	---------	----------	---------	--------	--------	-------------	----------

For M-TACTICAL Mounts, see page 62.

M-TACTICAL Reticles

The new M-TACTICAL line offers models with the newly designed MK1-MOA and MK1-MRAD reticles, as well as the platform-based, caliber-designated BDC 600 and BDC 800. The MK1 reticles can be used to estimate range, target size, elevation holdover and wind-drift at the designated magnification. The asymmetrical design allows for additional holdover for extreme distances. BDC reticles can be optimized for any caliber or load with Spot On Ballistic Technology at NikonSportOptics.com/SpotOn.

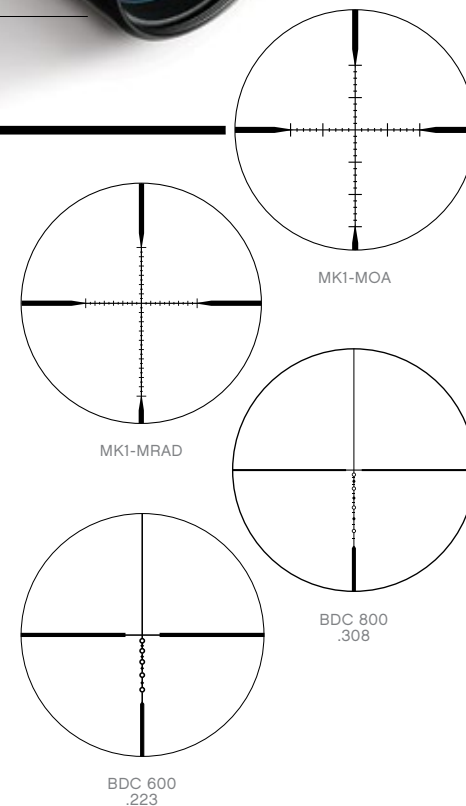



ENHANCE YOUR SHOOTING EXPERIENCE

Nikon's new P-TACTICAL riflescopes provide the features you need to maximize your shooting experience—regardless of the platform you mount it on. Fully multicoated optical systems housed in rugged, one-inch, aircraft-grade aluminum main tubes brighten even the most dismal environments and unforgiving conditions. The versatile 3x zoom ratio (on variable models) provides the field of view at the low end and the detail at the high end to satisfy most shooting demands. If you're a long-distance dialer, P-TACTICAL's new, hash-marked MK1-MOA or MK1-MRAD reticles are matched to ergonomic turrets with directional indicators to make every come-up—or down—both simple and intuitive. The MK1-MOA reticle is also available in P-TACTICAL Rimfire, for stretching the legs of any rimfire platform. Dedicated caliber models—including rimfire—match the reticle to your preferred caliber, and when used in conjunction with Nikon's free Spot On Ballistic Technology offer exact holdover points for any long-range engagement.



GENEROUS, CONSISTENT EYE RELIEF

Keeps your brow safe.

QUICK FOCUS EYEPIECE

Smooth-turn aluminum ring with rubberized eye guard allows crisp reticle focus and quick target acquisition.

3x ZOOM RATIO

Offers flexibility for a variety of shooting situations.

ONE-INCH TUBE

Rugged, aircraft-grade aluminum main tube.

WATERPROOF

O-ring sealed to prevent moisture from entering body.

FOGPROOF

Nitrogen purged for total reliability against thermal shock.

SHOCKPROOF CONSTRUCTION

Shrugs off hard recoil and rugged use.

FULLY MULTICOATED OPTICS

Multiple layers of anti-reflective coating on all air-to-glass surfaces maximize light transmission, brightness and contrast.

SPRING-LOADED INSTANT ZERO-RESET TURRET

Spring-loaded Windage and Elevation knobs can be reset to "zero" after sighting-in for easy reference when making field adjustments.

DIRECTIONAL INDICATORS

Clearly marked on windage and elevation turrets.

P-TACTICAL Reticles

The new P-TACTICAL line offers models with the newly designed MK1-MOA and MK1-MRAD reticles, as well as the platform-based, caliber-designated BDC 150, BDC 600, BDC 800, BDC SUPERSUB and BDC CARBINE. The MK1-MOA and MK1-MRAD can be used to estimate range, target size, elevation holdover and wind-drift at the designated magnification. An asymmetrical design allows for additional holdover for extreme distance shooting.

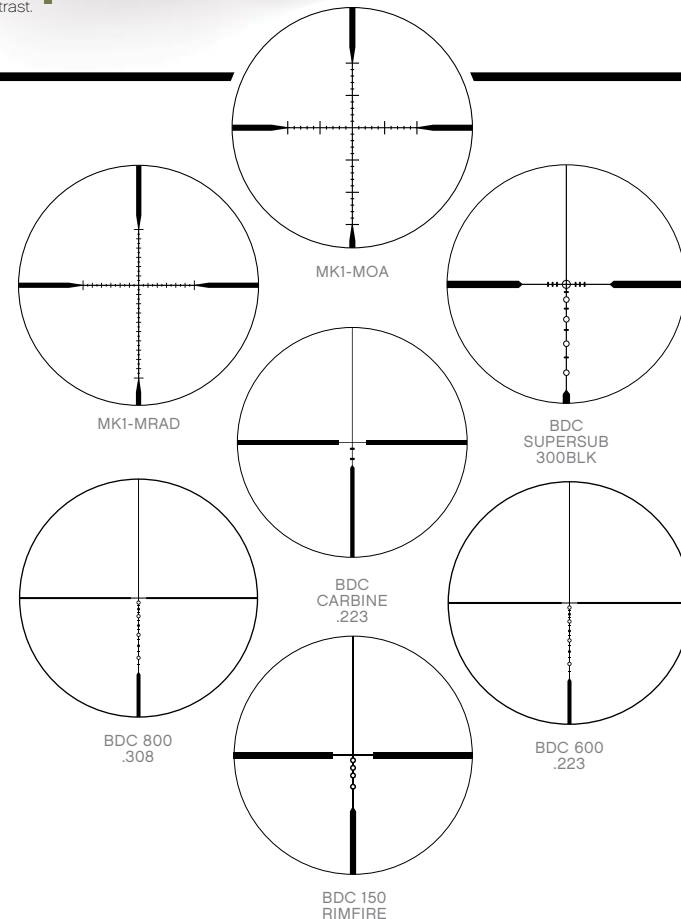

P-TACTICAL

	RETICLE	WEIGHT (OZ)	LENGTH (IN)	EYE RELIEF (IN)	FOV @ 100 YDS	ADJUST GRAD	MAX INTERNAL ADJUST	TRAVEL PER ROTATION	PARALLAX (YDS)	SRP	
16530	3-9x40 Matte	MK1-MOA	16.9	12.4	3.6-3.6	33.5-11.5	1/4 MOA	75 MOA	20 MOA	100	\$199.95
16531	3-9x40 Matte	MK1-MRAD	16.9	12.4	3.6-3.6	33.5-11.5	0.1 MRAD	20 MRAD	8 MRAD	100	\$199.95

P-TACTICAL .308

16523	4-12x40 Matte	BDC 800	17.5	14.1	3.7-3.7	23.6-7.9	1/4 MOA	55 MOA	20 MOA	100	\$249.95
-------	---------------	---------	------	------	---------	----------	---------	--------	--------	-----	----------

P-TACTICAL 300BLK

16522	2-7x32 Matte	BDC SUPERSUB	16.2	11.5	3.8	44.6-12.6	1/4 MOA	90 MOA	20 MOA	100	\$199.95
-------	--------------	--------------	------	------	-----	-----------	---------	--------	--------	-----	----------

P-TACTICAL .223

16527	1.5-4.5x20 Matte	BDC 600	14.8	10.2	3.5-3.5	63.1-20.4	1/4 MOA	150 MOA	20 MOA	100	\$189.95
16526	3x32 Matte	BDC CARBINE	12.7	8.2	3.4	35.6	1/4 MOA	130 MOA	20 MOA	100	\$149.95
16525	3-9x40 Matte	BDC 600	16.9	12.4	3.6-3.6	33.5-11.5	1/4 MOA	75 MOA	20 MOA	100	\$199.95
16524	4-12x40 Matte	BDC 600	17.5	14.1	3.7-3.7	23.6-7.9	1/4 MOA	55 MOA	20 MOA	100	\$249.95

P-TACTICAL RIMFIRE

16528	2-7x32 Matte	MK1-MOA	16.2	11.5	3.8-3.8	44.6-12.6	1/4 MOA	90 MOA	20 MOA	50	\$179.95
16529	2-7x32 Matte	BDC 150	16.2	11.5	3.8-3.8	44.6-12.6	1/4 MOA	90 MOA	20 MOA	50	\$179.95

For P-TACTICAL Mounts, see page 62.



NEW

RUGGED AND RELIABLE—NEW OPTICS FOR EVERY GUN

The new P-TACTICAL SPUR and SUPERDOT each provide incredible image clarity, a crisp red sighting dot and the compact, lightweight specification needed for fast point-and-shoot action. Engineered for extreme durability and reliability regardless of platform, SPUR's lightweight aluminum alloy chassis is shockproof, waterproof and has a night vision compatible 3 MOA dot that boasts 15,000 hours of continuous use on a single battery. When outdoor conditions are at their worst, SUPERDOT securely houses internal components and night vision compatible 2 MOA dot within a shockproof, waterproof, aircraft-grade aluminum body that shrugs off rain, dirt, snow and mud. Both sights feature Nikon's proprietary TRUCOLOR lens-and-coating technology to provide a lifelike view with both-eyes-open sighting and offer 10 brightness settings.

SPUR REFLEX SIGHT

FULLY MULTICOATED OPTICS

Multiple layers of anti-reflective coating on all air-to-glass surfaces maximize light transmission, brightness and contrast.

WIDE FIELD OF VIEW

Get a full view of the environment.

EXTENDED BATTERY LIFE

With low battery indicator.

NIGHT VISION COMPATIBLE

Initial two brightness settings are compatible with night vision gear.

PICATINNY MOUNT

Removable mount is included with SPUR.



1x MAGNIFICATION

For both-eyes-open rapid engagement.

TRUCOLOR

Proprietary coating that minimizes the bluish tint common to reflex and dot sights.

WATERPROOF

IPX7 Specification.

SHOCKPROOF CONSTRUCTION

Shrugs off hard recoil and rugged use.

5-YEAR WARRANTY

10-LEVELS OF BRIGHTNESS SETTINGS

For virtually any light condition.

SUPERDOT RED DOT SIGHT

10-LEVELS OF BRIGHTNESS

For virtually any light condition.

EXTENDED BATTERY LIFE

With low battery indicator.

WIDE FIELD OF VIEW

Get a full view of the environment.

FULLY MULTICOATED OPTICS

Multiple layers of anti-reflective coating on all air-to-glass surfaces maximize light transmission, brightness and contrast.

INTEGRAL PICATINNY MOUNT

Includes spacers to provide 1/3 co-witness or full co-witness.



RAISED PROTRUSION

Functions as flat driver for adjustments.

1x MAGNIFICATION

For both-eyes-open rapid engagement.

TRUCOLOR

Proprietary coating that minimizes the bluish tint common to reflex and dot sights.

NIGHT VISION COMPATIBLE

Initial two brightness settings are compatible with night vision gear.

WATERPROOF

IPX7 Specification.

SHOCKPROOF CONSTRUCTION

Shrugs off hard recoil and rugged use.

5-YEAR WARRANTY

P-TACTICAL SPUR		RETICLE	BRIGHTNESS SETTINGS	SIGHT WINDOW (WxH) MM	WEIGHT (BODY) (OZ)	L x W x H (IN)	EYE RELIEF (IN)	DOT SIZE	ADJUST. GRAD.	ADJUST. SCREW PRINT (E/W)	MAX. INTERNAL ADJUST.	ADJUST. MECHANISM	TRAVEL PER ROTATION	PARALLAX (YDS)	SRP
16532	MATTE	RED DOT	10*	27x16	1.1	1.8x1.1x1.1 Rear HT 0.4	UNLIMITED	3 MOA	1 MOA	1 MOA	120 MOA	FLAT DRIVER	30 MOA	∞	\$219.95

*Includes Night Vision compatible settings.

P-TACTICAL SUPERDOT		RETICLE	BRIGHTNESS SETTINGS	SIGHT WINDOW (DIAMETER) MM	WEIGHT (BODY) (OZ)	L x W x H (IN)	EYE RELIEF (IN)	DOT SIZE	ADJUST. GRAD.	MAX. INTERNAL ADJUST.	ADJUST. MECHANISM	TRAVEL PER ROTATION	PARALLAX (YDS)	SRP
16510	MATTE	RED DOT	10*	22	4.2	2.8x1.7x1.7	UNLIMITED	2 MOA	1 MOA	100 MOA	FLAT DRIVER	40 MOA	∞	\$199.95

*Includes Night Vision compatible settings.

◀ Please see warranty card for limitations and exclusions.



MONARCH



FLAGSHIP HUNTING OPTICS

Our flagship MONARCH hunting riflescope lineup offers three distinct ways to elevate your chances for success this season. MONARCH 3 and MONARCH 5 bring the enhanced performance features serious hunters look for in rugged, capable, one-inch main body tube platforms. When a 30mm main body tube is a requisite, look no further than MONARCH 7 to push optical and mechanical excellence to a higher level. With any model in the MONARCH family, you are making a confident choice for a lifetime of serious hunting.

MONARCH MODEL COMPARISON

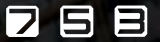

	7	5	3
Ultra ClearCoat Optical System	✓	✓	✓
One-Piece Main Tube	✓	✓	✓
30mm Main Tube	✓		
Optimized for Spot On Ballistic Match Technology	✓	✓	✓
ED Glass		✓	
Wide Field of View	✓		
Available 56mm Objective	✓		
Available Advanced BDC Reticle	✓	✓	
Available Illuminated Reticle	✓		
4-time zoom ratio	✓		✓
5-time zoom ratio		✓	
MONARCH Eye Box Technology	✓	✓	✓
Locking Side Focus Parallax Adjustment (on long range models)	✓	✓	✓
Quick Focus Eyepiece	✓	✓	✓
Waterproof/Fogproof/Shockproof	✓	✓	✓

MONARCH

EXPERIENCE EXCELLENCE

Nikon's flagship MONARCH 7 riflescopes offer a technological edge to its legendary platform. The Advanced BDC reticle, offered with an optional Illuminated Reticle, is a superb combination for long-distance shooting. Fully multicoated lenses and the enlarged 30mm main body tube reveal a superb field of view with pristine clarity. Instant Zero-Reset Turrets allow windage and elevation knobs to be reset to "zero" after sighting-in for easy reference when making field adjustments. When supplemented with Nikon's Spot On Ballistic Match Technology the MONARCH 7 turns distances, once thought to be inconceivable, into a lethal shot opportunity. Sunshade included.



QUICK FOCUS EYEPIECE

Smooth-turn rubberized ring allows crisp reticle focus and quick target acquisition.

4x ZOOM RATIO

Offers maximum magnification versatility.

GLASS-ETCHED RETICLE

Extremely durable, yet fine and detailed reticle design that maintains color and contrast in all light conditions.

WATERPROOF

O-ring sealed to prevent moisture from entering body.

FOGPROOF

Nitrogen purged for total reliability against thermal shock.

GENEROUS, CONSISTENT EYE RELIEF

Keeps your brow safe.

32-LEVEL RHEOSTET

On illuminated reticle mode.

LOCKING SIDE FOCUS PARALLAX ADJUSTMENT

Side Parallax knob allows adjustment without changing shooting position.

30mm MAIN BODY TUBE

Constructed of aircraft-grade aluminum with Type-III hard anodizing for maximum strength-to-weight ratio and optimum ruggedness.

SHOCKPROOF CONSTRUCTION

Shrugs off hard recoil and rugged use.

HEAVY RECOIL RESISTANT

Built to withstand the recoil of the hardest-hitting calibers.

FULLY MULTICOATED OPTICS

Multiple layers of anti-reflective coating on all air-to-glass surfaces maximize light transmission, brightness and contrast.



Hand turn Reticle Adjustments with Spring-Loaded Instant Zero-Reset Turrets. To simplify field adjustments, Nikon has integrated this feature into all MONARCH 7 Riflescopes. Just sight in as usual, then lift the adjustment knob, rotate to your "zero", and re-engage.

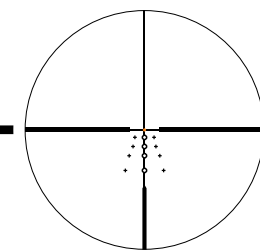

ILLUMINATION SHOWN

ADVANCED BDC

Advanced BDC Reticle

The glass-etched Advanced BDC reticle has unique circles going down the vertical sight post that are used as aiming points to compensate for bullet drop at extended ranges. It also has windage marks on both the left and right side of the post that are calibrated for a 10-mile-per-hour cross wind when the rifle is sighted in at 100 yards. Even if the cross wind is more or less than 10 mph, shooters now have a reliable benchmark to compensate for distance and windage. Illuminated reticle models have 32 levels of intensity on the center dot of the reticle.

MONARCH 7	ILL	RETICLE	WEIGHT (OZ)	LENGTH (IN)	EYE RELIEF (IN)	FOV-FT @ 100 YDS	ADJUST GRAD @ 100 YDS	MAX INTERNAL ADJUST	TRAVEL PER ROTATION @ 100 YDS	PARALLAX (YDS)	SRP
16370	2.5-10x50SF Matte	Advanced BDC	23.6	13.7	3.8-3.7	47.4-11.8	1/4 inch	92 MOA	24"	50-INFINITY	\$849.95
16371	4-16x50SF Matte	Advanced BDC	22.9	14.8	3.6-3.6	29.6-7.4	1/4 inch	58 MOA	24"	50-INFINITY	\$999.95
16372	4-16x50SF Matte	Advanced BDC w/Dot	24.9	14.8	3.6-3.6	29.6-7.4	1/4 inch	58 MOA	24"	50-INFINITY	\$1,099.95
16373	3-12x56SF Matte	Advanced BDC	23.8	14.3	3.7-3.7	39.4-9.8	1/4 inch	78 MOA	24"	50-INFINITY	\$999.95
16374	3-12x56SF Matte	Advanced BDC w/Dot	25.8	14.3	3.7-3.7	39.4-9.8	1/4 inch	78 MOA	24"	50-INFINITY	\$1,099.95



MONARCH 5



QUICK FOCUS EYEPIECE

Smooth-turn rubberized ring allows crisp reticle focus and quick target acquisition.

5x ZOOM RATIO

Offers extreme range of magnification adjustment.

ONE-INCH TUBE

Rugged, aircraft-grade aluminum main tube.

WATERPROOF

O-ring sealed to prevent moisture from entering body.

FOGPROOF

Nitrogen purged for total reliability against thermal shock.

HEAVY RECOIL RESISTANT

Built to withstand the recoil of the hardest-hitting calibers.

SHOCKPROOF CONSTRUCTION

Shrugs off hard recoil and rugged use.



GENEROUS, CONSISTENT EYE RELIEF

Keeps your brow safe.

SPRING-LOADED INSTANT ZERO-RESET TURRET

Spring-loaded Windage and Elevation knobs can be reset to "zero" after sighting-in for easy reference when making field adjustments.

SIDE FOCUS PARALLAX ADJUSTMENT

Locking Side Parallax knob allows adjustment without changing shooting position.

GLASS-ETCHED RETICLE

Extremely durable, yet fine and detailed reticle design that maintains color and contrast in all light conditions. Advanced BDC Models Only.

ED GLASS

ED (Extra-low Dispersion) glass reduces chromatic aberration to a remarkable degree, providing clear images with superior contrast.

FULLY MULTICOATED OPTICS

Multiple layers of anti-reflective coating on all air-to-glass surfaces maximize light transmission, brightness and contrast.

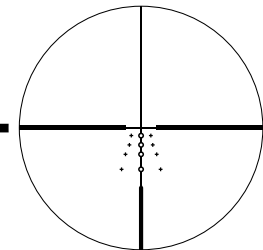

ADVANCED BDC

IMMACULATE CLARITY WITH SPOT ON™ PRECISION

MONARCH 5 riflescopes feature ED (Extra-low Dispersion) Glass and a 5-time zoom ratio for crystal-clear sight pictures at virtually any range and lighting condition. The glass-etched Advanced BDC reticle can be used in conjunction with Spot On Ballistic Technology to determine your precise aiming point for your specific cartridge at longer ranges. Sunshade included with all models.

Advanced BDC Reticle

The glass-etched Advanced BDC reticle has windage marks on both the left and right side of the post that are calibrated for a 10-mile-per-hour cross wind when the rifle is zeroed in at either 100 yards or 200 yards.

MONARCH

THE BENCHMARK OF RIFLESCOPE PERFORMANCE

The MONARCH flag flies high with the broad lineup of riflescopes that make up the MONARCH 3 series. With a full complement of features and a long list of flagship performance attributes, MONARCH 3 combines impressive optics and reliable mechanical functionality in a package fit for any fine rifle. Compatible with Spot On Custom Turrets. Sunshade adaptable.



QUICK FOCUS EYEPIECE

Smooth-turn rubberized ring allows crisp reticle focus and quick target acquisition.

4x ZOOM RATIO

Offers maximum magnification versatility.

ONE-INCH TUBE

Rugged, aircraft-grade aluminum main tube.

WATERPROOF

O-ring sealed to prevent moisture from entering body.

FOGPROOF

Nitrogen purged for total reliability against thermal shock.

SHOCKPROOF CONSTRUCTION

Shrugs off hard recoil and rugged use.

FULLY MULTICOATED OPTICS

Multiple layers of anti-reflective coating on all air-to-glass surfaces maximize light transmission, brightness and contrast.

GENEROUS, CONSISTENT EYE RELIEF

Keeps your brow safe.

SIDE FOCUS PARALLAX ADJUSTMENT

Side Parallax knob allows adjustment without changing shooting position.

CUSTOM XR TURRET

Available in select models.

FIRST FOCAL PLANE

Available in select models.

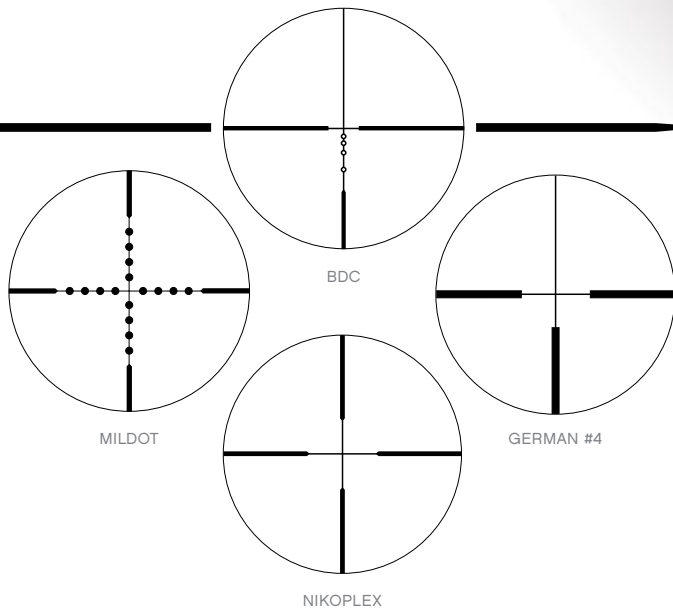

With the MONARCH 3 line, you can choose the reticle that fits your style of shooting/hunting: The BDC reticle allows hunters to hold "dead-on" at ranges exceeding those previously thought possible. Nikoplex for a traditional plex reticle. The German #4 with its fine center crosshair and three bold lines at 3, 6 and 9. The Mildot reticle, with its 1 Mil dot spacing on the crosshair for ranging. The Nikoplex with Custom XR Turret pairs the Nikoplex reticle with a custom engraved elevation turret based upon your unique cartridge and environmental data. This made-to-order elevation turret dial replaces the factory turret that comes with your rifle scope.

MONARCH 5		RETICLE	WEIGHT (OZ)	LENGTH (IN)	EYE RELIEF (IN)	FOV-FT @ 100 YDS	ADJUST GRAD @ 100 YDS	MAX INTERNAL ADJUST	TRAVEL PER ROTATION @ 100 YDS	PARALLAX (YDS)	SRP
16356	4-20x50ED SF Matte	ADVANCED BDC	21.3	14.7	3.9-3.5	24.7-5.1	1/4 inch	45 MOA	12"	50-INFINITY	\$699.95
16360	6-30x50ED SF Matte	ADVANCED BDC	20.6	15.7	3.9-3.4	16.6-3.4	1/4 inch	30 MOA	12"	50-INFINITY	\$949.95
MONARCH 3		RETICLE	WEIGHT (OZ)	LENGTH (IN)	EYE RELIEF (IN)	FOV-FT @ 100 YDS	ADJUST GRAD @ 100 YDS	MAX INTERNAL ADJUST	TRAVEL PER ROTATION @ 100 YDS	PARALLAX (YDS)	SRP
6757	1-4x20 Matte	GERMAN #4	12.1	9.3	4.1-4	92.9-23.1	1/2 inch	120 MOA	24"	100	\$279.95
6762	2.5-10x42 Matte	BDC	16.6	12.6	4-3.8	40.3-10.1	1/4 inch	70 MOA	12"	100	\$399.95
6768	3-12x42SF Matte	BDC	18.7	13.1	4-3.7	33.6-8.4	1/4 inch	60 MOA	12"	50-INFINITY	\$439.95
16362	3-12x42SF FFP Matte	BDC	18	13.1	4-3.7	31.8-8.0	1/4 inch	48 MOA	12"	50-INFINITY	\$549.95
6770	4-16x42SF Matte	BDC	19	13.5	4-3.7	25.2-6.3	1/4 inch	40 MOA	12"	50-INFINITY	\$459.95
6771	4-16x42SF Matte	MILDOT	19	13.5	4-3.7	25.2-6.3	1/4 inch	40 MOA	12"	50-INFINITY	\$469.95
6781	4-16x42SF Matte	NIKOPLEX w/XR TURRET	19.8	13.5	4-3.7	25.2-6.3	1/4 inch	40 MOA	12"	50-INFINITY	\$499.95
16363	4-16x42SF FFP Matte	BDC	18	13.5	4-3.7	23.9-6.0	1/4 inch	36 MOA	12"	50-INFINITY	\$579.95
6774	4-16x50SF Matte	NIKOPLEX	19.4	14.7	4-3.7	25.2-6.3	1/4 inch	40 MOA	12"	50-INFINITY	\$499.95
6775	4-16x50SF Matte	BDC	19.4	14.7	4-3.7	25.2-6.3	1/4 inch	40 MOA	12"	50-INFINITY	\$499.95
16364	4-16x50SF FFP Matte	BDC	19.4	14.7	4-3.7	23.9-6.0	1/4 inch	36 MOA	12"	50-INFINITY	\$629.95
6773	5-20x44SF Matte	BDC	19	14.1	4-3.6	20.1-5	1/8 inch	34 MOA	6"	50-INFINITY	\$559.95
6777	6-24x50SF Matte	BDC	20.5	15.5	4-3.6	16.8-4.2	1/8 inch	30 MOA	6"	50-INFINITY	\$699.95



PROSTAFF



FIELD PROVEN RUGGEDNESS AND OPTICAL PERFORMANCE

Whether you were born to hunt—or caught the bug somewhere along the way—there’s a Nikon PROSTAFF riflescope built around your passion and your needs. From this field-proven family, choose from the tough-as-nails PROSTAFF base models, the full-featured PROSTAFF 5 or the extreme-long-range-capable PROSTAFF 7. Throughout the PROSTAFF line you can be confident in trademark Nikon optical quality, adjustment integrity and a reputation for ruggedness that is beyond reproach.

PROSTAFF MODEL COMPARISON			
Fully Multicoated Optical System	✓	✓	✓
30mm Main Tube	✓		
Available BDC Reticle	✓	✓	✓
Optimized for Spot On Ballistic Match Technology	✓	✓	✓
Extensive Range of Windage & Elevation Adjustment	✓		
4-time zoom ratio	✓	✓	
Side Focus Parallax Adjustment (on long range models)	✓	✓	
Quick Focus Eyepiece	✓	✓	✓
Waterproof/Fogproof/Shockproof	✓	✓	✓

PROSTAFF 7

LONG-RANGE HUNTING PERFORMANCE

Low-light situations require superior glass and light gathering ability. Nikon's PROSTAFF 7 riflescope has all the features to ensure a successful hunt—especially in those crucial times near dawn and dusk. Built with Nikon's high-quality Fully Multicoated lenses, 30mm main body tubes and 4-time zoom magnification ratio, the PROSTAFF 7 riflescope is another winning product in the long line of Nikon Sport Optics. Spot On Custom Turret compatible. Sunshade included with 4-16 and 5-20 models.



QUICK FOCUS EYEPIECE
Smooth-turn rubberized ring allows crisp reticle focus and quick target acquisition.

4x ZOOM RATIO
Offers maximum magnification versatility.

WATERPROOF
O-ring sealed to prevent moisture from entering body.

FOGPROOF
Nitrogen purged for total reliability against thermal shock.

SHOCKPROOF CONSTRUCTION
Shrugs off hard recoil and rugged use.

GENEROUS, CONSISTENT EYE RELIEF
Keeps your brow safe.

SPRING-LOADED INSTANT ZERO-RESET TURRET
Spring-loaded Windage and Elevation knobs can be reset to "zero" after sighting-in for easy reference when making field adjustments.

SIDE FOCUS PARALLAX ADJUSTMENT
Side Parallax knob allows adjustment without changing shooting position.

30mm MAIN BODY TUBE
Constructed of aircraft-grade aluminum with Type-III hard anodizing for maximum strength-to-weight ratio and optimum ruggedness.

FULLY MULTICOATED OPTICS
Multiple layers of anti-reflective coating on all air-to-glass surfaces maximize light transmission, brightness and contrast.



Hand turn Reticle Adjustments with Spring-Loaded Instant Zero-Reset Turrets. To simplify field adjustments, Nikon has integrated this feature into all PROSTAFF 7 Riflescopes. Just sight in as usual, then lift the adjustment knob, rotate to your "zero", and re-engage.

PROSTAFF 7

	RETICLE	WEIGHT (OZ)	LENGTH (IN)	EYE RELIEF (IN)	FOV-FT @ 100 YDS	ADJUST GRAD @ 100 YDS	MAX INTERNAL ADJUST	TRAVEL PER ROTATION @ 100 YDS	PARALLAX (YDS)	SRP	
16318	2.5-10x42 Matte	BDC	18.3	12.6	4-3.7	43.6-10.9	1/4 inch	140 MOA	12"	100	\$299.95
16319	2.5-10x50 Matte	NIKOPLEX	20.3	13.7	4-3.7	43.6-10.9	1/4 inch	140 MOA	12"	100	\$349.95
16320	2.5-10x50 Matte	BDC	20.3	13.7	4-3.7	43.6-10.9	1/4 inch	140 MOA	12"	100	\$349.95
16322	3-12x42SF Matte	BDC	19.4	13.2	4-3.6	39.4-9.1	1/4 inch	120 MOA	12"	50-INFINITY	\$349.95
16324	4-16x42SF Matte	BDC	19.4	13.6	4-3.6	27.2-6.8	1/4 inch	90 MOA	12"	50-INFINITY	\$449.95
16325	4-16x50SF Matte	NIKOPLEX	22	14.8	4-3.6	27.2-6.8	1/4 inch	90 MOA	12"	50-INFINITY	\$499.95
16326	4-16x50SF Matte	BDC	22	14.8	4-3.6	27.2-6.8	1/4 inch	90 MOA	12"	50-INFINITY	\$499.95
16335	5-20x50SF Matte	BDC	21.5	15	4-3.6	21.8-5.5	1/4 inch	70 MOA	12"	50-INFINITY	\$549.95

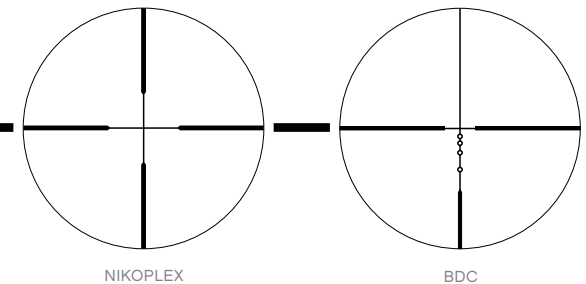

Choice of Nikoplex or BDC Reticle.

The BDC reticle allows hunters to hold "dead-on" at ranges exceeding those previously thought possible. The BDC's unique see-through ballistic circles offer an incredible advantage for long-range shooting—yet allow a normal sight picture for shorter-range shots where the crosshair itself is the aiming point.



PROSTAFF 5

A HIGHER DEGREE OF PERFORMANCE

The PROSTAFF 5 series features rifle-scope technology that will satisfy even the most demanding hunters and shooters. A remarkably bright optical system, precise hand-turn reticle adjustments with spring-loaded Instant Zero-Reset turrets, and a convenient quick-focus eyepiece with a 4x zoom ratio, make adjustments while in a shooting position a breeze. PROSTAFF 5 riflescopes are built with fully multicoated optics for maximum light transmission, even in extreme low light environments. The PROSTAFF 5 line includes select First Focal Plane models, as well as a Custom XR Turret model. Spot On Custom Turret compatible. Sunshade included with 4.5-18 models.



QUICK FOCUS EYEPIECE
Smooth-turn rubberized ring allows crisp reticle focus and quick target acquisition.

4x ZOOM RATIO
Offers maximum magnification versatility.

WATERPROOF
O-ring sealed to prevent moisture from entering body.

FOGPROOF
Nitrogen purged for total reliability against thermal shock.

SHOCKPROOF CONSTRUCTION
Shrugs off hard recoil and rugged use.

FIRST FOCAL PLANE
Available in select models.

FULLY MULTICOATED OPTICS
Multiple layers of anti-reflective coating on all air-to-glass surfaces maximize light transmission, brightness and contrast.

SPRING-LOADED INSTANT ZERO-RESET TURRET
Spring-loaded Windage and Elevation knobs can be reset to "zero" after sighting-in for easy reference when making field adjustments.

SIDE FOCUS PARALLAX ADJUSTMENT
Side Parallax knob allows adjustment without changing shooting position.

ONE-INCH TUBE
Rugged, aircraft-grade aluminum main tube.

CUSTOM XR TURRET
Available in select models.



Hand turn Reticle Adjustments with Spring-Loaded Instant Zero-Reset Turrets. To simplify field adjustments, Nikon has integrated this feature into all PROSTAFF 5 Riflescopes. Just sight in as usual, then lift the adjustment knob, rotate to your "zero", and re-engage.

PROSTAFF 5		RETICLE	WEIGHT (OZ)	LENGTH (IN)	EYE RELIEF (IN)	FOV-FT @ 100 YDS	ADJUST GRAD @ 100 YDS	MAX INTERNAL ADJUST	TRAVEL PER ROTATION @ 100 YDS	PARALLAX (YDS)	SRP
6735	2.5-10x40 Matte	NIKOPLEX	15.3	12.6	3.7-4.0	40.4-9.9	1/4 inch	70 MOA	12"	100	\$229.95
6736	2.5-10x40 Matte	BDC	15.3	12.6	3.7-4.0	40.4-9.9	1/4 inch	70 MOA	12"	100	\$229.95
6737	2.5-10x40 Silver	BDC	15.3	12.6	3.7-4.0	40.4-9.9	1/4 inch	70 MOA	12"	100	\$249.95
6739	2.5-10x50 Matte	BDC	18	13.7	3.7-4.0	40.4-9.9	1/2 inch	70 MOA	12"	100	\$329.95
6740	3.5-14x40SF Matte	NIKOPLEX	17.3	13.6	3.7-4.0	28.6-7.2	1/4 inch	55 MOA	12"	50-INFINITY	\$299.95
6741	3.5-14x40SF Matte	BDC	17.3	13.6	3.7-4.0	28.6-7.2	1/4 inch	55 MOA	12"	50-INFINITY	\$299.95
6742	3.5-14x40SF Silver	BDC	17.3	13.6	3.7-4.0	28.6-7.2	1/4 inch	55 MOA	12"	50-INFINITY	\$319.95
6743	3.5-14x40SF Matte	MILDOT	17.3	13.6	3.7-4.0	28.6-7.2	1/4 inch	55 MOA	12"	50-INFINITY	\$299.95
6754	3.5-14x40SF Matte	NIKOPLEX w/XR TURRET	18	13.6	3.7-4.0	28.6-7.2	1/4 inch	55 MOA	12"	50-INFINITY	\$349.95
16365	3.5-14x40SF FFP Matte	BDC	16.8	13.6	4.0-4.0	25.7-6.5	1/4 inch	55 MOA	12"	50-INFINITY	\$359.95
6745	3.5-14x50SF Matte	BDC	19.4	14.3	3.7-4.0	28.6-7.2	1/4 inch	55 MOA	12"	50-INFINITY	\$399.95
16366	3.5-14x50SF FFP Matte	BDC	18.9	14.3	4.0-4.0	25.7-6.5	1/4 inch	55 MOA	12"	50-INFINITY	\$459.95
6747	4.5-18x40SF Matte	BDC	17.1	13.6	3.7-4.0	22.4-5.6	1/4 inch	40 MOA	12"	50-INFINITY	\$399.95
6748	4.5-18x40SF Matte	MILDOT	17.1	13.6	3.7-4.0	22.4-5.6	1/8 inch	40 MOA	6"	50-INFINITY	\$399.95
16367	4.5-18x40SF FFP Matte	BDC	16.8	13.6	4.0-4.0	20.1-5.0	1/8 inch	40 MOA	6"	50-INFINITY	\$459.95

PROSTAFF

DELIVERS WITH EVERY SHOT

Tested and proven in the field by Nikon PROSTAFF members, the PROSTAFF line of riflescopes will help you stay on target in virtually any conditions. The entire PROSTAFF riflescope series integrates Nikon's fully multicoated optical system, Spring-Loaded Instant Zero-Reset Turrets and Spot On optimized reticles. You can rest easy knowing that Nikon will never cut corners on optics, ruggedness or precision. Compatible with Spot On Custom Turrets.

QUICK FOCUS EYEPIECE

Smooth-turn rubberized ring allows crisp reticle focus and quick target acquisition.

3x ZOOM RATIO

Offers flexibility for a variety of hunting situations.

ONE-INCH TUBE

Rugged, aircraft-grade aluminum main tube.

FULLY MULTICOATED OPTICS

Multiple layers of anti-reflective coating on all air-to-glass surfaces maximize light transmission, brightness and contrast.

WATERPROOF

O-ring sealed to prevent moisture from entering body.

FOGPROOF

Nitrogen purged for total reliability against thermal shock.

SHOCKPROOF CONSTRUCTION

Shrugs off hard recoil and rugged use.

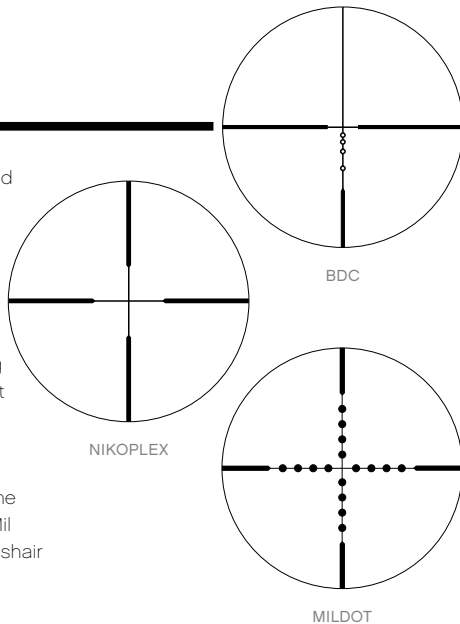

With the PROSTAFF 5 and PROSTAFF line, you can choose the reticle/focal plane that fits your style of shooting/hunting: The BDC reticle allows hunters to hold "dead-on" at ranges exceeding those previously thought possible, and three First Focal Plane models are available. Nikoplex for a traditional plex reticle. The Mildot reticle, with its 1 Mil dot spacing on the crosshair for ranging. Custom XR Turret models utilize the Nikoplex reticle (see page 23).



Precise Hand-turn 1/4-inch click adjustments. Positive-click reticle adjustments get you zeroed in quicker and maintain your setting even with heavy recoil.

PROSTAFF

	RETICLE	WEIGHT (OZ)	LENGTH (IN)	EYE RELIEF (IN)	FOV-FT @ 100 YDS	ADJUST GRAD @ 100 YDS	MAX INTERNAL ADJUST	TRAVEL PER ROTATION @ 100 YDS	PARALLAX (YDS)	SRP	
6719	2-7x32 Matte	NIKOPLEX	13.9	11.5	3.8-3.8	44.5-12.7	1/4 inch	80 MOA	12"	100	\$149.95
6721	3-9x40 Matte	NIKOPLEX	15	12.4	3.6-3.6	33.8-11.3	1/4 inch	80 MOA	12"	100	\$179.95
6722	3-9x40 Matte	BDC	15	12.4	3.6-3.6	33.8-11.3	1/4 inch	80 MOA	12"	100	\$179.95
6723	3-9x40 Silver	BDC	15	12.4	3.6-3.6	33.8-11.3	1/4 inch	80 MOA	12"	100	\$189.95
6726	3-9x50 Matte	NIKOPLEX	17.5	12.5	3.6-3.6	33.8-11.3	1/4 inch	80 MOA	12"	100	\$229.95
6727	3-9x50 Matte	BDC	17.5	12.5	3.6-3.6	33.8-11.3	1/4 inch	80 MOA	12"	100	\$229.95
6728	4-12x40 Matte	NIKOPLEX	15.9	14.1	3.7-3.7	23.6-7.9	1/4 inch	60 MOA	12"	100	\$219.95
6729	4-12x40 Matte	BDC	15.9	14.1	3.7-3.7	23.6-7.9	1/4 inch	60 MOA	12"	100	\$219.95
6732	4-12x40 Matte	MILDOT	15.9	14.1	3.7-3.7	23.6-7.9	1/4 inch	60 MOA	12"	100	\$219.95



PROSTAFF



NEW

FOR EVERY PURPOSE, THERE'S A PROSTAFF P3

With the new PROSTAFF P3 specialty scopes, Nikon introduces an exciting line of purpose-driven riflescopes. PROSTAFF P3 is the name of the new baseline of riflescopes within Nikon's mid-price-point PROSTAFF sub-brand line-up. The PROSTAFF sub-brand symbolizes toughness, solidity and practical utility, while emphasizing the product line's reliability and usefulness as tools for hunting and shooting. The PROSTAFF P3 name will now encompass all of Nikon's current specialty scopes, including models for predator hunting rifles, muzzleloaders, shotguns/slug guns, rimfire target rifles and air guns, and even crossbows.

NEW

SERIOUS ABOUT PREDATORS

With the introduction of the new PROSTAFF P3 PREDATOR HUNTER rifle-scope line, dedicated predator hunters can stop searching for a riflescope that offers optical performance, ruggedness and purpose-specific reticle technology. The PROSTAFF P3 PREDATOR HUNTER is available in both 3-9x40 and 4-12x40 and each offers bright, fully multicoated optics. Both models provide crisp, positive-click 1/4 MOA low-profile turret adjustments, rugged, all-aluminum, quick focus eyepiece, generous eye relief and Nikon's proprietary BDC Predator reticle, which is designed to facilitate shots at fast moving targets.



GENEROUS, CONSISTENT EYE RELIEF
Keeps your brow safe.

SPRING-LOADED INSTANT ZERO-RESET TURRET
Windage and Elevation knobs with aluminum turret caps, can be reset to "zero" after sighting-in for easy reference when making field adjustments. Now in 1/4 MOA graduations.

QUICK FOCUS EYEPIECE
Built of aluminum for increased durability and smooth use. (with rubber insert)

3x ZOOM RATIO
All-aluminum zoom control with ergonomic knurling pattern

WATERPROOF
O-ring sealed to prevent moisture from entering body.

FOGPROOF
Nitrogen purged for total reliability against thermal shock.

SHOCKPROOF CONSTRUCTION
Shrugs off hard recoil and rugged use.

ONE-INCH TUBE
Rugged, aircraft-grade aluminum main tube.

FULLY MULTICOATED OPTICS
Multiple layers of anti-reflective coating on all air-to-glass surfaces maximize light transmission, brightness and contrast.

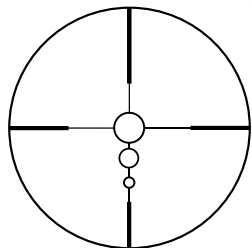

BDC PREDATOR

Nikon's BDC Predator Reticle.

This proprietary predator hunting reticle is designed to facilitate shots at moving targets. Featuring "stepped" ballistic open-design circles, the Predator reticle doesn't obscure the sight picture and makes shots at distant or smaller targets easier. Can be optimized with Spot On Ballistic Match Technology for various calibers and loads.

NEW PROSTAFF P3 PREDATOR HUNTER

	RETICLE	WEIGHT (OZ)	LENGTH (IN)	EYE RELIEF (IN)	FOV-FT @ 100 YDS	ADJUST GRAD @ 100 YDS	MAX INTERNAL ADJUST	TRAVEL PER ROTATION @ 100 YDS	PARALLAX (YDS)	SRP	
16609	3-9x40 Matte	BDC PREDATOR	15	12.4	3.6-3.6	33.5-11.5	1/4 MOA	75 MOA	12 MOA	100	\$249.95
16610	4-12x40 Matte	BDC PREDATOR	15.5	14.1	3.7-3.7	23.6-7.9	1/4 MOA	55 MOA	12 MOA	100	\$299.95

Optional sunshade is available



PROSTAFF MUZZLELOADER P3



THE RIGHT TOOL FOR LONG-RANGE MUZZLELOADING

Nikon's new purpose-built muzzleloader scope sports a new name, and new performance and durability features, but will still satisfy the most demanding muzzleloading hunters. Bright, fully multicoated optics ensure high light transmission and crisp, positive-click 1/4-MOA low-profile turrets provide ease of use. Durability upgrades include all-aluminum construction for the main body, zoom control, quick focus eyepiece (with rubber insert) and turret caps. Proven BDC 300 reticle technology is matched to the needs of hunters using muzzleloaders. The PROSTAFF P3 MUZZLELOADER 3-9x40 is available in matte black or silver.

NEW

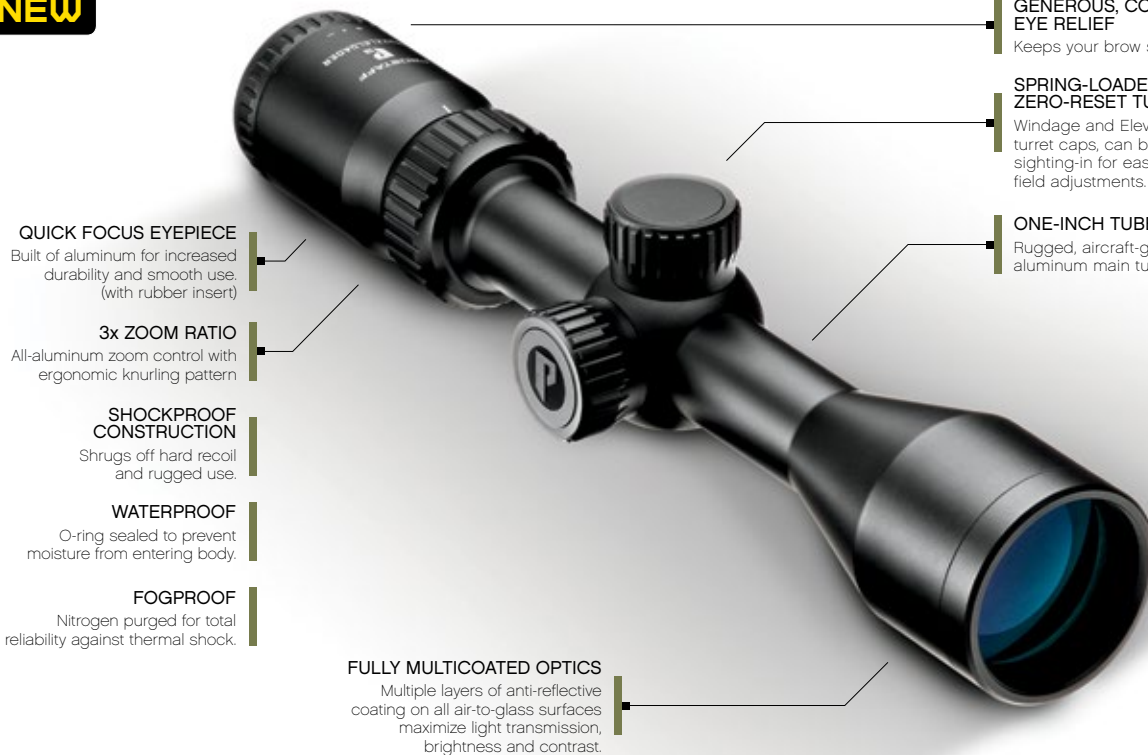

QUICK FOCUS EYEPIECE

Built of aluminum for increased durability and smooth use. (with rubber insert)

3x ZOOM RATIO

All-aluminum zoom control with ergonomic knurling pattern

SHOCKPROOF CONSTRUCTION

Shrugs off hard recoil and rugged use.

WATERPROOF

O-ring sealed to prevent moisture from entering body.

FOGPROOF

Nitrogen purged for total reliability against thermal shock.

FULLY MULTICOATED OPTICS

Multiple layers of anti-reflective coating on all air-to-glass surfaces maximize light transmission, brightness and contrast.

GENEROUS, CONSISTENT EYE RELIEF

Keeps your brow safe.

SPRING-LOADED INSTANT ZERO-RESET TURRET

Windage and Elevation knobs with aluminum turret caps, can be reset to "zero" after sighting-in for easy reference when making field adjustments. Now in 1/4 MOA graduations.

ONE-INCH TUBE

Rugged, aircraft-grade aluminum main tube.

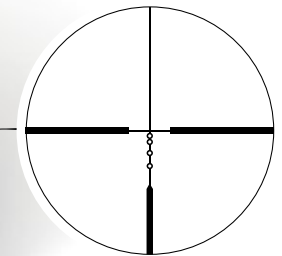

BDC 300 MUZZLELOADER

Nikon's BDC 300 Reticle

This trajectory-compensating reticle integrates unique, easy-to-see "ballistic circles" that provide instant aiming points and take the guesswork out of holdover at longer ranges. Optimized for use with Nikon's Spot On Ballistic Match Technology, the BDC 300 allows you to get exact aiming points at various yardages with virtually any load imaginable.

NEW PROSTAFF P3 MUZZLELOADER

	RETICLE	WEIGHT (OZ)	LENGTH (IN)	EYE RELIEF (IN)	FOV-FT @ 100 YDS	ADJUST GRAD @ 100 YDS	MAX INTERNAL ADJUST	TRAVEL PER ROTATION @ 100 YDS	PARALLAX (YDS)	SRP	
16603	3-9x40 Matte	BDC 300	15.2	11.4	3.6-3.6	25.1-8.4	1/4 MOA	55 MOA	12 MOA	100	\$199.95
16604	3-9x40 Silver	BDC 300	15.2	11.4	3.6-3.6	25.1-8.4	1/4 MOA	55 MOA	12 MOA	100	\$219.95

Optional sunshades are available



**PROSTAFF
SHOTGUN**



NEW

TAKE YOUR SLUG GUN LONGER RANGE

The new PROSTAFF P3 SHOTGUN scope line helps extend the effective range of your slug gun to 200 yards and beyond. An ideal match for today's powerful slug loads, these compact and versatile optics feature Nikon's BDC 200 reticle, precise 1/4 MOA adjustments with Spring-Loaded Instant Zero-Reset Turrets and fully multicoated optics for maximum light transmission. Offered in two configurations: 2-7x32 and 3-9x40, both with the BDC 200 reticle.



GENEROUS, CONSISTENT EYE RELIEF

Keeps your brow safe.

SPRING-LOADED INSTANT ZERO-RESET TURRET

Windage and Elevation knobs with aluminum turret caps, can be reset to "zero" after sighting-in for easy reference when making field adjustments. Now in 1/4 MOA graduations.

ONE-INCH TUBE

Rugged, aircraft-grade aluminum main tube.

QUICK FOCUS EYEPIECE

Built of aluminum for increased durability and smooth use. (with rubber insert)

3x ZOOM RATIO (3-9x40 model)

All-aluminum zoom control with ergonomic knurling pattern

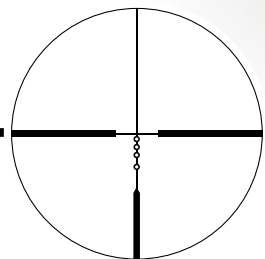

BDC 200 SHOTGUN

FULLY MULTICOATED OPTICS

Multiple layers of anti-reflective coating on all air-to-glass surfaces maximize light transmission, brightness and contrast.

WATERPROOF

O-ring sealed to prevent moisture from entering body.

FOGPROOF

Nitrogen purged for total reliability against thermal shock.

SHOCKPROOF CONSTRUCTION

Shrugs off hard recoil and rugged use.

Nikon's BDC 200 Reticle

The trajectory-compensating BDC 200 slug gun reticle integrates unique, easy-to-see "ballistic circles" that provide instant aiming points and take the guesswork out of holdover at longer ranges. Optimized for use with Nikon's Spot On Ballistic Match Technology, the BDC 200 provides exact aiming points at various yardages with virtually any load imaginable.

NEW PROSTAFF P3 SHOTGUN

	RETICLE	WEIGHT (OZ)	LENGTH (IN)	EYE RELIEF (IN)	FOV-FT @ 100 YDS	ADJUST GRAD @ 100 YDS	MAX INTERNAL ADJUST	TRAVEL PER ROTATION @ 100 YDS	PARALLAX (YDS)	SRP	
16607	2-7x32 Matte	BDC 200	14.3	11.5	3.8-3.8	44.6-12.6	1/4 MOA	90 MOA	12 MOA	100	\$159.95
16602	3-9x40 Matte	BDC 200	15.2	11.4	5-5	25.1-8.4	1/4 MOA	55 MOA	12 MOA	100	\$199.95

Optional sunshade available for 3-9x40 model.



THE RIGHT CHOICE FOR YOUR NEXT HUNT

Nikon's BUCKMASTERS II riflescope is designed for deer hunters across North America. Fully multicoated lenses and Nikon's favored BDC reticle provide high-resolution images during the peak deer movement windows of dawn and dusk. From the humid swamps of the South to the blistering cold wilderness of Canada, the BUCKMASTERS II will continue to be the preferred scope for deer hunters.

GENEROUS, CONSISTENT EYE RELIEF

Keeps your brow safe.

3x ZOOM RATIO

Offers flexibility for a variety of hunting situations.

WATERPROOF

O-ring sealed to prevent moisture from entering body.

FOGPROOF

Nitrogen purged for total reliability against thermal shock.

SHOCKPROOF CONSTRUCTION

Shrugs off hard recoil and rugged use.

SPRING-LOADED INSTANT ZERO-RESET TURRET

Spring-loaded Windage and Elevation knobs can be reset to "zero" after sighting-in for easy reference when making field adjustments.

ONE-INCH TUBE

Rugged, aircraft-grade aluminum main tube.

FULLY MULTICOATED OPTICS

Multiple layers of anti-reflective coating on all air-to-glass surfaces maximize light transmission, brightness and contrast.



Spring-Loaded Instant-Zero Reset Turrets engraved for maximum readability and internals provide precise, repeatable corrections while zeroing

BUCKMASTER II

	RETICLE	WEIGHT (OZ)	LENGTH (IN)	EYE RELIEF (IN)	FOV-FT @ 100 YDS	ADJUST GRAD @ 100 YDS	MAX INTERNAL ADJUST	TRAVEL PER ROTATION @ 100 YDS	PARALLAX (YDS)	SRP	
16338	3-9x40 Matte	BDC	13.1	12.3	3.6-3.6	33.8-11.3	1/4 inch	80 MOA	12"	100	\$129.95
16339	4-12x40 Matte	BDC	13.6	14	3.7-3.7	23.6-7.9	1/4 inch	60 MOA	12"	100	\$149.95
16419	3-9x50 Matte	BDC	15.9	12.4	3.6-3.6	33.8-11.3	1/4 inch	80 MOA	12"	100	\$159.95



EXTENDED EYE RELIEF HANDGUN SCOPES

Nikon has become the master of creating specific reticle technologies and optical platforms for the needs of the hunter. FORCE XR extended eye relief handgun scopes are no exception. Engineered with the option of Nikon's unique BDC Handgun reticle, the FORCE XR can be optimized with Nikon's Spot On Ballistic Match Technology to take the guesswork out of compensating for bullet drop of your favorite handgun cartridge and load.

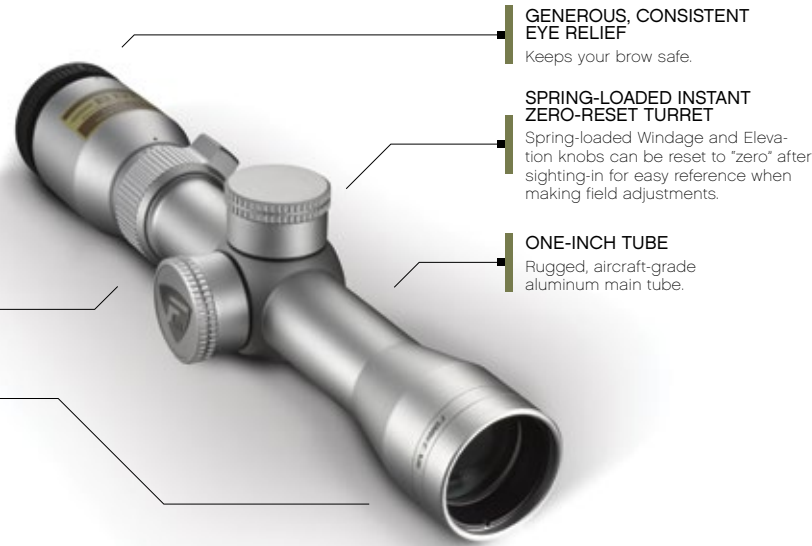

- WATERPROOF**
O-ring sealed to prevent moisture from entering body.
- FOGPROOF**
Nitrogen purged for total reliability against thermal shock.
- SHOCKPROOF CONSTRUCTION**
Shrugs off hard recoil and rugged use.
- 3x ZOOM RATIO**
Offers flexibility for a variety of hunting situations.
- FULLY MULTICOATED OPTICS**
Multiple layers of anti-reflective coating on all air-to-glass surfaces maximize light transmission, brightness and contrast.

GENEROUS, CONSISTENT EYE RELIEF

Keeps your brow safe.

SPRING-LOADED INSTANT ZERO-RESET TURRET

Spring-loaded Windage and Elevation knobs can be reset to "zero" after sighting-in for easy reference when making field adjustments.

ONE-INCH TUBE

Rugged, aircraft-grade aluminum main tube.

SPRING-LOADED INSTANT ZERO-RESET TURRET

Windage and Elevation knobs with aluminum turret caps, can be reset to "zero" after sighting-in for easy reference when making field adjustments. Now in 1/4 MOA graduations.

QUICK FOCUS EYEPIECE

Built of aluminum for increased durability and smooth use. (with rubber insert)

ONE-INCH TUBE

Rugged, aircraft-grade aluminum main tube.

FULLY MULTICOATED OPTICS

Multiple layers of anti-reflective coating on all air-to-glass surfaces maximize light transmission, brightness and contrast.

SHOCKPROOF CONSTRUCTION

Shrugs off hard recoil and rugged use.

WATERPROOF

O-ring sealed to prevent moisture from entering body.

FOGPROOF

Nitrogen purged for total reliability against thermal shock.

NEW



PRECISION OPTIC FOR CROSSBOW HUNTERS

The new PROSTAFF P3 CROSSBOW is the ideal choice for hunters looking to upgrade the optic on their crossbows this season. Signature Nikon optical performance coupled with a proprietary BDC reticle designed specifically to maximize the range and efficiency of today's hunting crossbows.

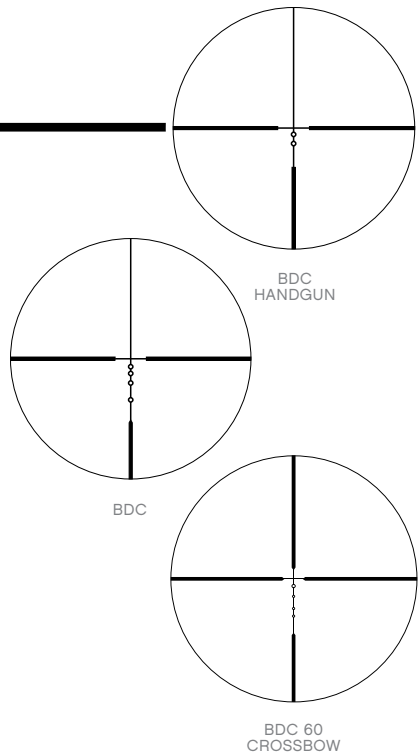

The BDC reticle allows hunters to hold 'dead-on' at ranges exceeding those previously thought possible. The BDC's unique see-through ballistic circles offer an incredible advantage for long-range shooting, yet allow a normal sight picture for shorter-range shots where the crosshair itself is the aiming point.

FORCE XR	RETICLE	WEIGHT (OZ)	LENGTH (IN)	EYE RELIEF (IN)	FOV-FT @ 100 YDS	ADJUST GRAD @ 100 YDS	MAX INTERNAL ADJUST	TRAVEL PER ROTATION @ 100 YDS	PARALLAX (YDS)	SRP	
8468	2.5-8x28 EER Matte	BDC	14.5	9.8	12-30 (at 2.5x) 9-13 (at 8x)	13.1-4.1	1/4 inch	40 MOA	12"	100	\$289.95
8469	2.5-8x28 EER Silver	BDC	14.5	9.8	12-30 (at 2.5x) 9-13 (at 8x)	13.1-4.1	1/4 inch	40 MOA	12"	100	\$299.95
8470	2x20 EER Matte	Nikoplex	7.4	8.2	9.7-22.4	20.4	1/2 inch	120 MOA	24"	100	\$189.95
8471	2x20 EER Silver	Nikoplex	7.4	8.2	9.7-22.4	20.4	1/2 inch	120 MOA	24"	100	\$199.95
NEW PROSTAFF P3 CROSSBOW											
16608	3x32 Matte	BDC 60	10.9	8.2	3.4	35.6	1 MOA	130 MOA	48 MOA	20	\$159.95



RIMFIRE



A RIMFIRE RIFLESCOPE MODEL FOR EVERY USE

Nikon's RIMFIRE riflescope series has a scope model for virtually any rimfire rifle. The new P-TACTICAL RIMFIRE riflescope offers a 2-7x32 optical system and reticle that is designed for the versatility of every RIMFIRE rifle. The BDC 150 Reticle and the fully multicoated optical system of the PROSTAFF RIMFIRE II deliver nail-driving precision to rimfire long rifles. PROSTAFF Target EFR with Adjustable Objective is well suited for either rimfire or air rifles. Every RIMFIRE model will extract optimal accuracy from rimfire rifles, especially when used with Spot On Ballistic Match Technology.

QUICK FOCUS EYEPIECE

Smooth-turn aluminum ring with rubberized eye guard allows crisp reticle focus and quick target acquisition.

WATERPROOF

O-ring sealed to prevent moisture from entering body.

FOGPROOF

Nitrogen purged for total reliability against thermal shock.

SHOCKPROOF CONSTRUCTION

Shrugs off hard recoil and rugged use.

FULLY MULTICOATED OPTICS

Multiple layers of anti-reflective coating on all air-to-glass surfaces maximize light transmission, brightness and contrast.

TACTICAL RIMFIRE

SPRING-LOADED INSTANT ZERO-RESET TURRET

Spring-loaded Windage and Elevation knobs can be reset to "zero" after sighting-in for easy reference when making field adjustments.

ONE-INCH TUBE

Rugged, aircraft-grade aluminum main tube.



BDC 150 RIMFIRE

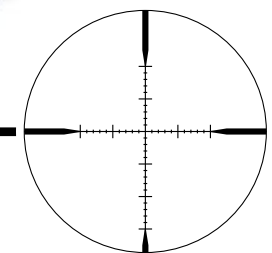

MK1-MOA

P-TACTICAL RIMFIRE

	RETICLE	WEIGHT (OZ)	LENGTH (IN)	EYE RELIEF (IN)	FOV-FT @ 100 YDS	ADJUST GRAD @ 100 YDS	MAX INTERNAL ADJUST	TRAVEL PER ROTATION	PARALLAX (YDS)	SRP	
16528	2-7x32 Matte	MK1-MOA	16.2	11.5	3.8-3.8	44.6-12.6	1/4 MOA	90 MOA	20 MOA	50	\$179.95
16529	2-7x32 Matte	BDC 150	16.2	11.5	3.8-3.8	44.6-12.6	1/4 MOA	90 MOA	20 MOA	50	\$179.95

The new P-TACTICAL RIMFIRE scope offers models with the newly designed MK1-MOA reticle, as well as the caliber-designated BDC 150 (see page 33 for RIMFIRE II & EFR). The MK1-MOA reticle can be used to estimate range, target size, elevation holder and wind-drift at designated magnification.

PROSTAFF RIMFIRE

Designed specifically for rimfire, the BDC 150 reticle allows shooters to compensate for bullet drop at extended shooting distances. The BDC's unique see-through ballistic circles offer an incredible advantage for long-range shooting—yet allow a normal sight picture for shorter-range shots where the crosshair itself is the aiming point.

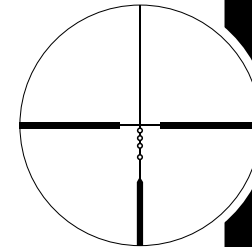

BDC 150
RIMFIRE



SPRING-LOADED INSTANT ZERO-RESET TURRET

Spring-loaded Windage and Elevation knobs can be reset to "zero" after sighting-in for easy reference when making field adjustments.

ONE-INCH TUBE

Rugged, aircraft-grade aluminum main tube.

WATERPROOF

O-ring sealed to prevent moisture from entering body.

FOGPROOF

Nitrogen purged for total reliability against thermal shock.

SHOCKPROOF CONSTRUCTION

Shrugs off hard recoil and rugged use.

FULLY MULTICOATED OPTICS

Multiple layers of anti-reflective coating on all air-to-glass surfaces maximize light transmission, brightness and contrast.



SPRING-LOADED INSTANT ZERO-RESET TURRET

Windage and Elevation knobs with aluminum turret caps, can be reset to "zero" after sighting-in for easy reference when making field adjustments. Now in 1/4 MOA graduations.

ONE-INCH TUBE

Rugged, aircraft-grade aluminum main tube.

EXTENDED FOCUS RANGE

Adjustable Objective Lens Dials Out Parallax from 10 yards to Infinity.

QUICK FOCUS EYEPIECE

Built of aluminum for increased durability and smooth use. (with rubber insert)

WATERPROOF

O-ring sealed to prevent moisture from entering body.

FOGPROOF

Nitrogen purged for total reliability against thermal shock.

SHOCKPROOF CONSTRUCTION

Shrugs off hard recoil and rugged use.

FULLY MULTICOATED OPTICS

Multiple layers of anti-reflective coating on all air-to-glass surfaces maximize light transmission, brightness and contrast.

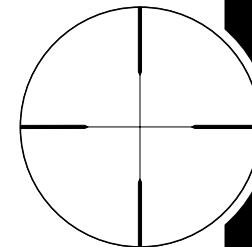

PRECISION

NEW

PROSTAFF TARGET EFR

PURPOSE-DRIVEN ENGINEERING

The new PROSTAFF P3 TARGET EFR is engineered for air rifle, 22 LR and other applications where the versatility of focusing on smaller targets at extended ranges—both close and distant—is needed. To facilitate this sharp focus at closer ranges, the PROSTAFF P3 TARGET EFR integrates an adjustable objective lens that allows the shooter to dial out parallax at any distance from 10 yards to infinity.

PROSTAFF RIMFIRE II

	RETICLE	WEIGHT (OZ)	LENGTH (IN)	EYE RELIEF (IN)	FOV-FT @ 100 YDS	ADJUST GRAD @ 100 YDS	MAX INTERNAL ADJUST	TRAVEL PER ROTATION @ 100 YDS	PARALLAX (YDS)	SRP	
16329	3-9x40 Matte	BDC 150	13.1	12.3	3.6-3.6	33.8-11.3	1/4 MOA	80 MOA	12"	50	\$119.95
16330	4-12x40 Matte	BDC 150	13.6	14	3.7-3.7	23.6-7.9	1/4 MOA	60 MOA	12"	75	\$139.95

NEW PROSTAFF P3 TARGET EFR

16606	3-9x40 AO Matte	PRECISION	16.6	12.5	3.6-3.6	33.5-11.5	1/4 MOA	75 MOA	12 MOA	10-∞	\$189.95
-------	-----------------	-----------	------	------	---------	-----------	---------	--------	--------	------	----------

Optional sunshade is available



LASER RANGEFINDERS





REDEFINING LONG RANGE

For 2018, Nikon has taken a giant leap forward in ranging technology and capability with the introduction of the BLACK RANGEX 4K and MONARCH 3000 STABILIZED laser rangefinders. These two all-new rangefinders eclipse everything in the field when it comes to long-range performance and extend what was previously thought possible of a rangefinder in this class. They join a capable and proven family of Nikon rangefinders engineered for speed, precision, ruggedness, and ergonomics—one of which is destined to become an essential part of your long-range shooting kit.



MONARCH 3000 STABILIZED



TRU-TARGET

Technology that allows you to switch between First Target and Distant Target modes.

STABILIZED

Image-stabilized to provide the easiest single-handed operation.

8-SECOND SUSTAINED MEASUREMENT

Continuously measure single or across multiple targets.

FULLY MULTICOATED OPTICS

Multiple layers of anti-reflective coating on all air-to-glass surfaces maximize light transmission, brightness and contrast.

ID TECHNOLOGY

Delivers the one number you need for your best shot to account for incline or decline shooting angles.

HYPER READ

Laser provides quick and stable measurement response regardless of distance (approx. 0.3 seconds).

WIDE FIELD OF VIEW

7.5 degrees

3,000 YARD MEASUREMENT RANGE

Maximum measurement distance*
Reflective Target - 3,000 yards
Maximum measurement distance*
Tree - 1,100 yards
Maximum measurement distance*
Deer - 1,000 yards

OLED DISPLAY

High visibility red display provides ideal contrast on distant targets.

WATERPROOF

O-ring sealed to prevent moisture from entering body.

FOGPROOF

Nitrogen purged for total reliability against thermal shock.

5-YEAR WARRANTY



STABLE VIEW (WITH STABILIZED)



UNSTABLE VIEW (WITHOUT STABILIZED)

UNSHAKABLE IS UNBEATABLE.

The new MONARCH 3000 STABILIZED is the latest example of Nikon's innovative and award-winning rangefinder technology at work. With an effective range of nearly 2 miles on reflective targets, we've tripled the ranging capability compared to our breakthrough image-stabilized laser rangefinder introduced last year. Designed for single-handed operation, the MONARCH 3000 STABILIZED instantly stabilizes the image you see in the 6x monocular and simultaneously activates HYPER READ for extraordinarily fast, positive measurements. For 2018, we've also added an all-new variable intensity red OLED reticle display that provides either automatic or five selectable brightness levels for maximum contrast against most targets and backgrounds. The MONARCH 3000 STABILIZED, equipped with Nikon's ID Technology for incline/decline shooting, will change your perception of rangefinder capability and performance.

4,000 YARD MEASUREMENT RANGE
 Maximum measurement distance*
 Reflective Target - 4,000 yards
 Maximum measurement distance*
 Tree - 1,700 yards
 Maximum measurement distance*
 Deer - 1,500 yards

8-SECOND SUSTAINED MEASUREMENT
 Continuously measure single or across multiple targets.

Tru-Target Technology enables you to choose between two different ranging modes, depending on the situation.

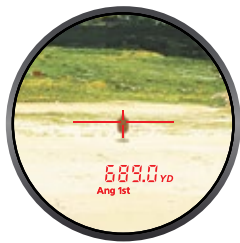

First Target Priority Mode

Provides the exact distance to the closest object among a group of targets being measured. In this mode, you can easily range an object as small as a fence post.

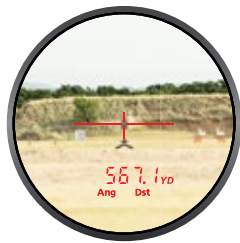

Distant Target Priority Mode

Displays the range of the farthest target among a group of targets measured. This feature is especially useful if the subject is located behind tall grass or brush.

OLED DISPLAY
 High visibility red display provides ideal contrast on distant targets.

TRU-TARGET
 Technology that allows you to switch between First Target and Distant Target modes.

FULLY MULTICOATED OPTICS
 Multiple layers of anti-reflective coating on all air-to-glass surfaces maximize light transmission, brightness and contrast.

HYPER READ
 Laser provides quick and stable measurement response regardless of distance (approx. 0.3 seconds).

ID TECHNOLOGY
 Delivers the one number you need for your best shot to account for incline or decline shooting angles.

WIDE FIELD OF VIEW
 7.5 degrees

5-YEAR WARRANTY



WATERPROOF
 O-ring sealed to prevent moisture from entering body.

FOGPROOF
 Nitrogen purged for total reliability against thermal shock.

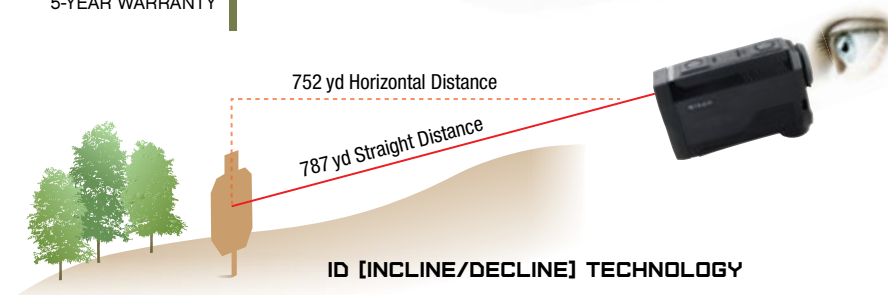

ID [INCLINE/DECLINE] TECHNOLOGY

Nikon's advanced ID [Incline/Decline] Technology provides the horizontal distance to the target, even when ranging at various incline or decline shooting angles—up to an incredible +/- 89 degrees [nearly vertical up or down].

BLACK RANGEX 4K

LONG RANGE JUST GOT LONGER

Working out the solution for a crucial shot means you need an accurate range right now, regardless of the distance. Nikon's new BLACK RANGEX 4K is engineered to deliver over 2 miles of ranging capability with the speed, precision and consistency you need for extreme long-distance shooting. Featuring Nikon's HYPER READ for extraordinarily fast, positive measurements, the rangefinder's integral monocular offers the bright, sharp view required for target spotting and acquisition. BLACK RANGEX 4K's high-visibility red OLED display provides ideal contrast on distant targets with automatic or five stages of selectable brightness. And for incline or decline shooting angles, the RANGEX is equipped with Nikon's ID Technology that delivers the one number you need for determining your best shot.

MONARCH 3000 STABILIZED	MAG. OBJ DIA.	EYE RELIEF (MM)	REAL ANGULAR FOV (DEGREES)	FOV @ 1000 YARDS (FT)	MAX RANGE (REFLECTIVE)* (YDS)	MAX RANGE (TREE)* (YDS)	MAX RANGE (DEER)* (YDS)	WEIGHT (W/O BATTERIES) (OZ)	SIZE (LxHxW) (IN)	SRP
16556	6x21	18.0	7.5	39.3	3,000	1,100	1,000	6.9	3.8x2.9x1.7	\$419.95
BLACK RANGEX 4K										
16557	6x21	18.3	7.5	39.3	4,000	1,700	1,500	6.3	4.3x2.9x1.6	\$449.95

*Reference value. Under Nikon's measurement conditions. The specifications of the product may not be achieved depending on the target object's shape, surface texture and nature, and/or weather conditions. The technology behind the Laser Rangefinder with inclinometer originated from technology incorporated in Nikon's Total Station DTM-1 surveying instrument. The Total Station DTM-1, first sold in 1985, was the first highly advanced electronic model of those surveying instruments that incorporated a distance and angle measuring capability developed by Nikon Corporation.



LaserForce



ONE MILE OF INSTANT GRATIFICATION

Combine Nikon binocular performance with the extreme speed and ranging technology of a 1900-yard laser rangefinder* and you have LaserForce, Nikon's 10x42 Rangefinder Binocular. Quite simply, LaserForce is the single optic solution for serious hunters who depend on both their binocular for picking out distant animals and their rangefinder for getting the exact distance before taking the shot. Featuring ED (Extra-low Dispersion) glass and Nikon's ID Technology to deliver the one number you need for incline or decline angles, LaserForce puts ranging precision, optical performance and rugged performance within your reach.



8-SECOND SUSTAINED MEASUREMENT

Continuously measure single or across multiple targets.

DIOPTER CONTROL

Allows crisp focus balance to your eyes.

MODE CONTROL

Select yards or meters and brightness.



BRIGHT OLED DISPLAY

High visibility red display provides ideal contrast on distant targets. 4-step intensity adjustment.

DISPLAY ADJUSTMENT

Allows short focus of OLED.

FULLY MULTICOATED OPTICS

Multiple layers of anti-reflective coating on all air-to-glass surfaces maximize light transmission, brightness and contrast.

AUTO POWER SHUT-OFF FUNCTION

Saves battery life, shuts down after 8 seconds of non-use.

PRECISION DISPLAY

Displays in .1-yard increments to 100 yards, 1-yard increments over 100 yards.

FLIP DOWN OBJECTIVE COVERS

Included with LaserForce.

RUBBER ARMOR

Provides a good grip, wet or dry.

ID TECHNOLOGY

Delivers the one number you need for your best shot to account for incline or decline shooting angles.

ED GLASS

ED (Extra-low Dispersion) glass reduces chromatic aberration to a remarkable degree, providing clear images with superior contrast.

WATERPROOF

O-ring sealed to prevent moisture from entering body.

FOGPROOF

Nitrogen purged for total reliability against thermal shock.



LIFETIME REPAIR/REPLACEMENT

Excludes lost or stolen products and intentionally caused damage.

Rangefinder Binocular with 10-1,900 yard range*

Maximum measurement distance*

Reflective Target - 1,900 yards

Maximum measurement distance*

Tree - 1,400 yards

Maximum measurement distance*

Deer - 1,100 yards

*Reference value. Under Nikon's measurement conditions.

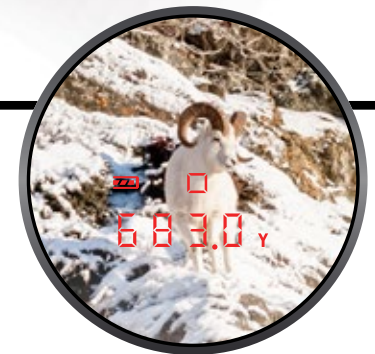

LASERFORCE		FINISH	EYE RELIEF (MM)	REAL ANGULAR FOV (DEGREES)	FOV @ 1000 YDS (FT)	MAX REFLECTIVE RANGE (YDS)	CLOSE FOCUS (FT)	WEIGHT (W/O BATTERIES) (OZ)	SIZE (LxWxH) (IN)	SRP
16212	10x42 RF Bino	BLACK	15.5	6.1	320	1,900	23	30.9	5.8x5.2x2.8	\$1,199.95



PROSTAFF 7i

CONFIDENCE TO 1,300 YARDS

The PROSTAFF 7i 6x21 Laser Rangefinder features an 8-1300 yard measurement range and is built with Nikon's advanced laser rangefinding technologies. With 1/2-yard precision displayed in .1-yard increments*, the PROSTAFF 7i offers vital micro-precision to any archer in tight with their prey, while giving long-range shooters sniper-like precision to execute long-range shots with confidence. Tru-Target™ Priority System and Nikon's ID (Incline/Decline) Technology, combined, factor the angle of your target whether it is exposed in the open or tucked in tight cover and offers the true "shoot-for" distance. PROSTAFF 7i is the one rangefinder that is up to any hunting or shooting endeavor.

LONG EYE RELIEF
Provides 15mm or more of eye relief. Perfect for eyeglass wearers.

TRU-TARGET
Technology that allows you to switch between First Target and Distant Target modes.

MODES
Select between yards, meters, first target or distant target priority.

MULTICOATED OPTICS
Multilayer-coated lenses for brighter images.

ID TECHNOLOGY
Delivers the one number you need for your best shot to account for incline or decline shooting angles.



HYPER READ
Laser provides quick and stable measurement response regardless of distance (0.5 seconds).

8-SECOND SUSTAINED MEASUREMENT
Continuously measure single or across multiple targets.

WATERPROOF
O-ring sealed to prevent moisture from entering body.

2-YEAR WARRANTY

PROSTAFF 3i

CONSISTENCY WHEN IT MATTERS MOST

The PROSTAFF 3i Laser Rangefinder and its ergonomic weather resistant housing make it a strong consideration for any shooter needing a rangefinder that will stay out of their way until it's needed. The 6x optical system with 1/2-yard accuracy out to 650 yards and Nikon's proven ID (Incline/Decline) Technology packs a mighty technological punch into its lean design.

LONG EYE RELIEF
Provides 15mm or more of eye relief (12mm+ for compacts). Perfect for eyeglass wearers.

TRU-TARGET
Technology that allows you to switch between First Target and Distant Target modes.

MODES
Select between yards, meters, first target or distant target priority.

MULTICOATED OPTICS
Multilayer-coated lenses for brighter images.

ID TECHNOLOGY
Delivers the one number you need for your best shot to account for incline or decline shooting angles.



HYPER READ
Laser provides quick and stable measurement response regardless of distance (0.5 seconds).

8-SECOND SUSTAINED MEASUREMENT
Continuously measure single or across multiple targets.

RAINPROOF
Offers confidence in damp environments.

2-YEAR WARRANTY

8-SECOND SUSTAINED MEASUREMENT

Continuously measure single or across multiple targets.

MULTICOATED OPTICS

Multilayer-coated lenses for brighter images.



LONG EYE RELIEF

Provides 15mm or more of eye relief. Perfect for eyeglass wearers.

RAINPROOF

Offers confidence in damp environments.

2-YEAR WARRANTY

TRU-TARGET

Technology that allows you to switch between First Target and Distant Target modes.

MULTICOATED OPTICS

Multilayer-coated lenses for brighter images.

ID TECHNOLOGY

Delivers the one number you need for your best shot to account for incline or decline shooting angles.



LONG EYE RELIEF

Provides 15mm or more of eye relief. Perfect for eyeglass wearers.

RAINPROOF

Offers confidence in damp environments.

2-YEAR WARRANTY

ACULON

A LIGHTWEIGHT PERFORMANCE HEAVYWEIGHT

The ultra-compact ACULON was designed to minimize weight and deliver performance. Nikon's lightest rangefinder contains a 6x20 multicoated optical system, offering precise ranging out to 550 yards. ACULON is easy to use and ready to put on miles in any adventure.

ARROW ID 3000

BOWHUNTING LASER RANGEFINDER

Tailored to the range-finding needs of archery hunters and competitors across the globe, the Nikon ARROW ID 3000 calculates the shot slope and distance, immediately providing your "shoot-for" distance. With a durable and ergonomic design, water resistant/rainproof housing, and refreshing eye relief, the engineers had the serious archery hunter and shooter in mind. The innovative Tru-Target Priority System and Nikon's ID (Incline/Decline) Technology empowers the ARROW ID 3000 to remove the guesswork out of your shot's equation so you can focus on the most critical aspect of your hunt or competition: making your best shot.

PROSTAFF 7i	MAG. OBJ DIA.	EYE RELIEF (MM)	REAL ANGULAR FOV (DEGREES)	FOV @ 100 YARDS (FT)	MAX RANGE (REFLECTIVE)* (YDS)	MAX RANGE (TREE)* (YDS)	MAX RANGE (DEER)* (YDS)	WEIGHT (W/O BATTERIES) (OZ)	SIZE (LxHxW) (IN)	SRP
16209	6x21	18.3	7.5	39.3	1,300	1,050	1,000	6.2	4.4x2.8x1.5	\$299.95
PROSTAFF 3i										
16229	6x21	18.3	7.5	39.3	650	600	550	5.6	4.4x2.8x1.4	\$229.95
ACULON DARK GREEN										
8397	6x20	16.7	6	31.4	550	525	500	4.4	3.6x2.9x1.5	\$169.95
ARROW ID 3000										
16224	4x20	20.3	9	47.2	550	550	550	4.8	3.6x2.9x1.5	\$199.95

*Reference value. Under Nikon's measurement conditions.



MONARCH





EXPERIENCE BETTER GLASS

With its legendary bloodlines and enhanced optical systems, the MONARCH Series of all-terrain binoculars maximizes every hour you spend in the field. With incredibly bright, high-resolution views, each is engineered to perform from the first rays of light until the very last. For 2018, every MONARCH binocular now utilizes Nikon's renowned ED (Extra-low Dispersion) glass and phase correction prisms with dielectric high reflective multilayer coatings to deliver a level of performance unlike any other. Combined with an inherent ruggedness and unmatched reputation for success, MONARCH will continue to prove itself as the greatest family in hunting.

MONARCH MODEL COMPARISON



	HG	7	S
Enhanced Quality Optical System	✓	✓	✓
Fully Multicoated Lenses	✓	✓	✓
Armor Coating on External Lenses	✓	✓	✓
Phase Correction Coated Prisms	✓	✓	✓
Magnesium Alloy Body	✓		
Field Flatteners Lens System	✓		
Dielectric High Reflective Multilayer Prism Coating	✓	✓	✓
ED Glass Lenses	✓	✓	✓
Wide Field of View	✓	✓	✓
Lead-and-Arsenic Free Glass	✓	✓	✓
Long Eye Relief	✓	✓	✓
Turn-and-slide rubber eyecups	✓	✓	✓
Rubber Armored body	✓	✓	✓
Waterproof, Fogproof Construction	✓	✓	✓



MONARCH

HG



NEW

THE MOST AWARDED MONARCH. EVER. NOW IN 30MM!

Every precious moment you spend in the field deserves the advantage of extraordinary performance. The new MONARCH HG 30mm series follows in the footsteps of its award-winning 42mm siblings in delivering class-ruling optical performance, unrivaled ruggedness and exceptional handling. Engineered throughout to match the performance specifications of the original 8x42 and 10x42 models, the new 30mm MONARCH HG binoculars do so in a smaller size and nearly 8 ounce reduction in weight.



WIDE FIELD OF VIEW

Wide Field of View Binoculars have fields of view of 60° or greater.

LOCKING DIOPTER

Retains your personal setting.

WATERPROOF

O-ring sealed to prevent moisture from entering body.

FOGPROOF

Nitrogen purged for total reliability against thermal shock.

FULLY MULTICOATED OPTICS

Multiple layers of anti-reflective coating on all air-to-glass surfaces maximize light transmission, brightness and contrast.

ARMOR LENS COATING

Scratch-resistant coatings for eyepiece and objective lenses.

ED GLASS

ED (Extra-low Dispersion) glass reduces chromatic aberration to a remarkable degree, providing clear images with superior contrast.

FIELD FLATTENER LENS SYSTEM

Delivers sharp images all the way to the edge of the field of view.

LONG EYE RELIEF

Provides 15mm or more of eye relief. Perfect for eyeglass wearers.

TURN & SLIDE EYECUPS

Perfect for use with or without eyeglasses.

MAGNESIUM ALLOY BODY

Lightweight and incredibly durable.

FLIP-DOWN OBJECTIVE COVERS

Included along with replacement rubber objective trim rings (shown).



30mm model



Stronger. Lighter. More Agile.

Because a binocular of this significance must always perform and do so without weighing you down, MONARCH HG's body is die-cast magnesium alloy. Providing optimum strength, impact resiliency and weight reduction, the slim body profile is further enhanced with rubberized panels to provide a sure grip in any conditions.



42mm model

MONARCH HG		FINISH	EYE RELIEF (MM)	REAL ANGULAR FOV (DEGREES)	FOV @ 1000 YDS (FT)	CLOSE FOCUS (FT)	WEIGHT (OZ)	SIZE (LxW) (IN)	SRP
16575	8x30 NEW	BLACK	16.2	8.3	435	6.6	15.9	4.7x5	\$949.95
16576	10x30 NEW	BLACK	15.2	6.9	362	6.6	15.9	4.7x5	\$969.95
16027	8x42	BLACK	17.8	8.3	435	6.6	23.5	5.7x5.2	\$979.95
16028	10x42	BLACK	17	6.9	362	6.6	24	5.7x5.2	\$999.95



MONARCH



LONG EYE RELIEF

Provides 15mm or more of eye relief (12mm+ for compacts). Perfect for eyeglass wearers.

TURN & SLIDE EYECUPS

Perfect for use with or without eyeglasses.

WIDE FIELD OF VIEW

Wide Field of View Binoculars have fields of view of 60° or greater. Except 8x42 model.



ED GLASS

ED (Extra-low Dispersion) glass reduces chromatic aberration to a remarkable degree, providing clear images with superior contrast.

FULLY MULTICOATED OPTICS

Multiple layers of anti-reflective coating on all air-to-glass surfaces maximize light transmission, brightness and contrast.

FLIP DOWN OBJECTIVE COVERS

Included with MONARCH 7.

WATERPROOF

O-ring sealed to prevent moisture from entering body.

FOGPROOF

Nitrogen purged for total reliability against thermal shock.

ARMOR LENS COATING

Scratch-resistant coatings for eyepiece and objective lenses. 42 inch models.

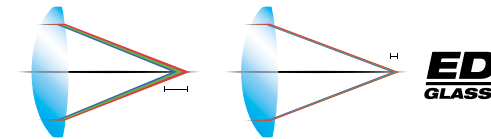

Normal Glass

ED Glass

(Used in all Monarch binoculars.)

YOUR GREATEST ADVENTURE AWAITS

Built to satisfy the incredible needs of today's serious outdoorsmen and women, this is a level of MONARCH that not only provides exquisite optical performance in a compact body delivering a wide field of view, but whose dynamic handling and rugged performance leave zero doubt as to its long-standing All Terrain Binocular heritage.

Dielectric high-reflective multilayer prism coating is applied to a roof prism unit that does not feature total internal reflection. This boosts light reflectivity of more than 99% (designed value) for the full visible range, giving you clearer whites and a sharper, brighter, more natural vision across the entire field of view.

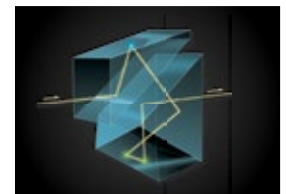

MONARCH 5

LIGHTWEIGHT CHAMPION OF DAWN & DUSK

Even with an uncontested heritage of all-conditions optical performance, the MONARCH 5 further elevates its game with improved agility and advanced low light brilliance. The addition of Nikon's ED glass lenses puts it in a class of its own for battling darkness with sharp, high-contrast views. The rubber-armored coating provides a non-slip grip in even the toughest environments.

LONG EYE RELIEF

Provides 15mm or more of eye relief (12mm+ for compacts). Perfect for eyeglass wearers.

TURN & SLIDE EYECUPS

Perfect for use with or without eyeglasses.

WATERPROOF

O-ring sealed to prevent moisture from entering body.

FOGPROOF

Nitrogen purged for total reliability against thermal shock.

FLIP DOWN OBJECTIVE COVERS

Included with MONARCH 5.



ED GLASS

ED (Extra-low Dispersion) glass reduces chromatic aberration to a remarkable degree, providing clear images with superior contrast.

FULLY MULTICOATED OPTICS

Multiple layers of anti-reflective coating on all air-to-glass surfaces maximize light transmission, brightness and contrast.

Multilayer coatings, which provide an even higher light transmittance across the entire visible light spectrum, are applied to all of the lens and prism surfaces that transmit light. This minimizes the loss of light due to reflection, thereby ensuring a more natural, clearer view.



MONARCH 7		FINISH	EYE RELIEF (MM)	REAL ANGULAR FOV (DEGREES)	FOV @ 1000 YDS (FT)	CLOSE FOCUS (FT)	WEIGHT (OZ)	SIZE (LxW) (IN)	SRP
7579	8x30	BLACK	15.1	8.3	435	6.6	15.3	4.7x4.8	\$379.95
7580	10x30	BLACK	15.8	6.7	351	6.6	15.5	4.7x4.8	\$399.95
7548	8x42	BLACK	17.1	8.0	420	8.2	22.9	5.6x5.1	\$479.95
7549	10x42	BLACK	16.5	6.7	351	8.2	23.3	5.6x5.1	\$499.95
MONARCH 5		FINISH	EYE RELIEF (MM)	REAL ANGULAR FOV (DEGREES)	FOV @ 1000 YDS (FT)	CLOSE FOCUS (FT)	WEIGHT (OZ)	SIZE (LxW) (IN)	SRP
7576	8x42	BLACK	19.5	6.3	330	8.2	20.8	5.7x5.1	\$279.95
7577	10x42	BLACK	18.4	5.5	288	8.2	21.2	5.7x5.1	\$299.95
7578	12x42	BLACK	15.1	5.0	262	8.2	21.2	5.7x5.1	\$319.95
7583	20x56	BLACK	16.4	3.3	173	16.4	43.6	7.8x5.7	\$899.95



PROSTAFF 7s



PASSION INSPIRED PERFORMANCE

Nikon's PROSTAFF 7S 10x42 is a lightweight, easy to hold, all-terrain binocular that features an advanced optical system designed to deliver sharper images. Thanks to fully multicoated lenses and Phase-Correction Coated Roof Prisms, every model in the PROSTAFF 7S series provides the quality, brightness and resolution that make it the perfect accessory for almost any outdoor activity.



PROSTAFF MODEL COMPARISON

Full Multilayer Coating on Lenses	✓		
Multilayer Coating on Lenses		✓	✓
Phase Correction Coated Prisms	✓		
Silver-Prism Coatings			✓
Wide Field of View			✓
Lead-and-Arsenic Free Glass	✓	✓	✓
High Reflection Mirror Coated Prisms	✓		
Long Eye Relief	✓	✓	✓
Turn-and-Slide Rubber Eyecups	✓	✓	✓
Rubber Armored body	✓	✓	✓
Waterproof, Fogproof Construction	✓	✓	✓

PROSTAFF 7s

	FINISH	EYE RELIEF (MM)	REAL ANGULAR FOV (DEGREES)	FOV @ 1000 YDS (FT)	CLOSE FOCUS (FT)	WEIGHT (OZ)	SIZE (LxW) (IN)	SRP
16000	8x30	BLACK	15.4	6.5	341	8.2	14.6 4.7x4.8	\$189.95
16001	10x30	BLACK	15.4	6.0	314	8.2	14.8 4.7x4.8	\$199.95
16002	8x42	BLACK	19.5	6.8	356	13.1	22.9 6.6x5.1	\$189.95
16003	10x42	BLACK	15.5	6.2	325	13.1	22.8 6.5x5.1	\$199.95
16004	10x42	Realtree Xtra® Green	15.5	6.2	325	13.1	22.8 6.5x5.1	\$219.95

LONG EYE RELIEF

Provides 15mm or more of eye relief (12mm+ for compacts). Perfect for eyeglass wearers.

TURN & SLIDE EYECUPS

Perfect for use with or without eyeglasses



FULLY MULTICOATED OPTICS

Multiple layers of anti-reflective coating on all air-to-glass surfaces maximize light transmission, brightness and contrast.

RUBBER ARMOR

Provides a good grip, wet or dry.

WATERPROOF

O-ring sealed to prevent moisture from entering body.

FOGPROOF

Nitrogen purged for total reliability against thermal shock.

LONG EYE RELIEF
Provides 15mm or more of eye relief (12mm+ for compacts). Perfect for eyeglass wearers.

RUBBER ARMOR
Provides a good grip, wet or dry.

MULTICOATED OPTICS
Multilayer-coated lenses for brighter images.

TURN & SLIDE EYECUPS
Perfect for use with or without eyeglasses

WATERPROOF
O-ring sealed to prevent moisture from entering body.

FOGPROOF
Nitrogen purged for total reliability against thermal shock.



PROSTAFF 5

BUILT TO HUNT AS HARD AS YOU DO

When hunting conditions are at their worst, PROSTAFF 5 Binoculars can be trusted to still give you the vision you demand. PROSTAFF 5 Binoculars feature superb optics, ergonomic design and waterproof, fogproof performance.

TURN & SLIDE EYECUPS
Perfect for use with or without eyeglasses.

RUBBER ARMOR
Provides a good grip, wet or dry.

MULTICOATED OPTICS
Multilayer-coated lenses for brighter images.

WIDE FIELD OF VIEW
Wide Field of View Binoculars have fields of view of 60° or greater. 10x42 model.

LONG EYE RELIEF
Provides 15mm or more of eye relief (12mm+ for compacts). Perfect for eyeglass wearers.

WATERPROOF
O-ring sealed to prevent moisture from entering body.

FOGPROOF
Nitrogen purged for total reliability against thermal shock.



PROSTAFF 3s

THE POWER OF PERFORMANCE

The PROSTAFF 3S binocular lives up to its namesake with bright, multicoated optics, wide field of view, long eye relief, and waterproof/fogproof performance. Notably lightweight and compact, the PROSTAFF 3S is a standout binocular for those looking for rugged-yet-portable optics worthy of any adventure.

PROSTAFF 5		FINISH	EYE RELIEF (MM)	REAL ANGULAR FOV (DEGREES)	FOV @ 1000 YDS (FT)	CLOSE FOCUS (FT)	WEIGHT (OZ)	SIZE (LxW) (IN)	SRP
7572	10x50	BLACK	19.6	5.6	293	16.4	28.7	7.4x5.5	\$199.95
7573	12x50	BLACK	15.5	4.7	246	16.4	27.9	7.4x5.5	\$219.95
PROSTAFF 3s		FINISH	EYE RELIEF (MM)	REAL ANGULAR FOV (DEGREES)	FOV @ 1000 YDS (FT)	CLOSE FOCUS (FT)	WEIGHT (OZ)	SIZE (LxW) (IN)	SRP
16030	8x42	BLACK	20.2	7.2	377	9.8	19.9	6x5.1	\$119.95
16031	10x42	BLACK	15.7	7.0	367	9.8	20.3	5.9x5.1	\$129.95



ACULON



VERSATILITY FOR EVERY SITUATION

The ACULON Series binoculars are great for a variety of hunting applications, thanks to the wide range of magnifications and sizes that are available. ACULON binoculars are a quality, cost-effective choice and a great fit for almost any activity.

ACULON A211

ACULON A211 binoculars feature multilayer-coated optics to deliver a high quality image under a multitude of lighting conditions, making these binoculars effective during those ever-important low-light hours of hunting near dawn and dusk. These binoculars have a central focus knob, a fully rubber armored body, and turn-and-slide rubber eyecups to simplify use with eyewear.



ACULON A211		FINISH	EYE RELIEF (MM)	REAL ANGULAR FOV (DEGREES)	FOV @ 1000 YDS (FT)	CLOSE FOCUS (FT)	WEIGHT (OZ)	SIZE (LxW) (IN)	SRP
8244	7x35	BLACK	11.8	9.3	488	16.4	24.2	4.6x7.3	\$79.95
8245	8x42	BLACK	12	8.0	420	16.4	26.6	5.7x7.3	\$89.95
8246	10x42	BLACK	11.6	6.0	314	16.4	26.8	5.7x7.3	\$99.95
8247	7x50	BLACK	17.6	6.4	335	26.2	31.9	7.1x7.8	\$109.95
8248	10x50	BLACK	11.8	6.5	341	23	31.7	7x7.8	\$119.95
8249	12x50	BLACK	11.5	5.2	272	26.2	32.1	7x7.8	\$129.95
8250	16x50	BLACK	12.6	4.2	220	29.5	32.6	7x7.8	\$139.95
8252	10-22x50 Zoom*	BLACK	8.6@10x	3.8	199@10x	49.2@10x	33.9	7.8x7.8	\$179.95

* Includes free Tripod Adapter



ACULON T11

The ACULON T11 ZOOM binocular is a portable, pocket-sized option. With the option of changing magnification anywhere between 8-power and 24-power through a centrally located zoom lever, this binocular will prove to be extremely versatile in many different circumstances. Turn-and-slide rubber eyecups simplify use with or without eyewear.



ACULON A30

A compact, lightweight roof prism binocular that is perfect for the hunt where you need to pack light. A smooth central focus knob and dual-hinge design are among its features. Available in 10x25 magnification, in black or Realtree Xtra® Green.



ACULON T11 ZOOM		FINISH	EYE RELIEF (MM)	REAL ANGULAR FOV (DEGREES)	FOV @ 1000 YDS (FT)	CLOSE FOCUS (FT)	WEIGHT (OZ)	SIZE (LxW) (IN)	SRP
7334	8-24x25	BLACK	13@8x	4.6	241@8x	13.1	10.8	4.8x4.3	\$149.95
ACULON A30		FINISH	EYE RELIEF (MM)	REAL ANGULAR FOV (DEGREES)	FOV @ 1000 YDS (FT)	CLOSE FOCUS (FT)	WEIGHT (OZ)	SIZE (LxW) (IN)	SRP
8263	10x25	BLACK	13	5.0	262	9.8	9.7	4.8x4.5	\$69.95
8264	10x25	REALTREE XTRA® GREEN	13	5.0	262	9.8	9.7	4.8x4.5	\$79.95



OCEANPRO



TURN & SLIDE EYECUPS

Perfect for use with or without eyeglasses.

LONG EYE RELIEF

Provides 15mm or more of eye relief (12mm+ for compacts). Perfect for eyeglass wearers.

SMOOTH CENTRAL FOCUS

Makes sharp focus simple.

ILLUMINATED GLOBAL COMPASS

Provides heading direction in any light or hemisphere.



FULLY MULTICOATED OPTICS

Multiple layers of anti-reflective coating on all air-to-glass surfaces maximize light transmission, brightness and contrast.

RUBBER ARMOR

Provides a good grip, wet or dry.

WATERPROOF

O-ring sealed to prevent moisture from entering body.

FOGPROOF

Nitrogen purged for total reliability against thermal shock.

BINOCULARS FOR THE MARINER

All mariners, including those traveling south of the equator, will appreciate Nikon's OceanPro binocular with integral global compass. Designed for use in Northern Hemisphere and Southern Hemisphere locations, the OceanPro with Global Compass and the standard OceanPro, with 7x magnification and 50mm objectives, achieve optimum viewing even in rough water. Quick central focus knob, rubber-armored, shockproof body, and included Nylon Floating Strap round out its features.

Action EX



LONG EYE RELIEF
Provides 15mm or more of eye relief (12mm+ for compacts). Perfect for eyeglass wearers.

TURN & SLIDE EYECUPS
Perfect for use with or without eyeglasses.

SMOOTH CENTRAL FOCUS
Makes sharp focus simple.

WATERPROOF
O-ring sealed to prevent moisture from entering body.

FOGPROOF
Nitrogen purged for total reliability against thermal shock.

MULTICOATED OPTICS
Multilayer-coated lenses for brighter images.

RUGGED ALL-TERRAIN BINOCULARS

The Action Extreme is a Porro prism with the waterproof and fogproof attributes of other Nikon All Terrain Binoculars. Nikon's lead-and-arsenic-free lenses and prism systems result in a high quality glass that is also lighter in weight. Each model features quick central focus knob, rubber armored body and multi-click turn-and-slide eyecups.

OCEANPRO CF WP		FINISH	EYE RELIEF (MM)	REAL ANGULAR FOV (DEGREES)	FOV @ 1000 YDS (FT)	CLOSE FOCUS (FT)	WEIGHT (OZ)	SIZE (LxW) (IN)	SRP
7440	7x50	BLACK	22.7	7.2	378	33	38	7.6x8.0	\$249.95
16026	7x50 Global Compass	BLACK	22.7	7.2	377	33	39.9*	7.6x8.0	\$299.95

*Weight without batteries

ACTION EXTREME		FINISH	EYE RELIEF (MM)	REAL ANGULAR FOV (DEGREES)	FOV @ 1000 YDS (FT)	CLOSE FOCUS (FT)	WEIGHT (OZ)	SIZE (LxW) (IN)	SRP
7237	7x35	BLACK	17.3	9.3	488	16.4	28.2	4.7x7.2	\$129.95
7238	8x40	BLACK	17.2	8.2	430	16.4	30.2	5.5x7.4	\$149.95
7239	7x50	BLACK	17.1	6.4	335	23.0	35.3	7.0x7.7	\$159.95
7245	10x50	BLACK	17.2	6.5	341	23.0	36.0	7.0x7.7	\$179.95
7246	12x50	BLACK	16.1	5.5	288	23.0	36.9	7.0x7.7	\$189.95
7247	16x50	BLACK	17.8	3.5	183	23.0	36.7	7.0x7.7	\$219.95



SPECIALTY BINOCULARS

WX

BINOCULAR OF THE CENTURY

The WX, in 7x50 and 10x50, is a hand-built, super-wide angle binocular delivering the widest field of view in Nikon's 100-year history, making it perfect for highly critical astronomical observation or highly-critical field use. Superior magnification and an incredible Apparent FOV (76.4° for the 10x50) make these your go-to optics for comet watching, stargazing or glassing entire hillsides without panning. This individual eye focus binocular features Abbe-Koenig prisms, which offer total reflection on all surfaces for a high light transmission rate. Tripod Adapter and hard case included. Objective lenses with filter threads to accept a 55mm filter (P=0.75) round out its features.

ULTRA-WIDE FIELD OF VIEW

This distinction belongs to Nikon's WX binocular, with Fields of View greater than 65° (76.4° for the 10x50 model).

FIELD FLATTENER LENS SYSTEM

Delivers sharp images all the way to the edge of the field of view.

ABBE-KOENIG PRISMS

Feature total reflection on all surfaces for a high light transmission rate, are utilized for a brighter field of view. Phase-correction coatings on these prisms yield high-resolution, high-contrast images.

HIGH-QUALITY MULTILAYER COATINGS

Multiple layers of anti-reflective coating on all air-to-glass surfaces maximize light transmission, brightness and contrast.

ED GLASS

Three pieces of ED (Extra-low Dispersion) glass in each tube reduces chromatic aberration to a remarkable degree, providing clear images with superior contrast.

LONG EYE RELIEF

Provides 15mm or more of eye relief. Perfect for eyeglass wearers.

FOGPROOF

Nitrogen purged for total reliability against thermal shock.

WATERPROOF

O-ring sealed to prevent moisture from entering body.

TRIPOD ADAPTER

Heavy-duty Tripod Adapter included for total stability.



PROSTAFF



- WATERPROOF**
O-ring sealed to prevent moisture from entering body.
- FOGPROOF**
Nitrogen purged for total reliability against thermal shock.
- MULTICOATED OPTICS**
Multilayer-coated lenses for brighter images.

- SMOOTH CENTRAL FOCUS KNOB**
Fast range of focus for quick viewing.
- LONG EYE RELIEF**
Provides 15mm or more of eye relief (12mm+ for compacts). Perfect for eyeglass wearers.
- Rubber-armored coating**
Provides a fast, sure, non-slip grip.
- BAK4 HIGH INDEX PRISMS**
Provide extra-high resolution images.

TRAVELITE



- MULTICOATED OPTICS**
Multilayer-coated lenses for brighter images.

- SMOOTH CENTRAL FOCUS KNOB**
Fast range of focus for quick viewing.
- BAK4 HIGH INDEX PRISMS**
Provide extra-high resolution images.

TRAILBLAZER



- ROOF PRISM DESIGN**
Folds to fit in pocket.
- WATERPROOF**
O-ring sealed to prevent moisture from entering body.
- FOGPROOF**
Nitrogen purged for total reliability against thermal shock.
- MULTICOATED OPTICS**
Multilayer-coated lenses for brighter images.

- SMOOTH CENTRAL FOCUS KNOB**
Fast range of focus for quick viewing.

COMPACTS

TAKE IT WITH YOU

Experienced hunters know that a good compact is worth its weight in gold. When every ounce counts, Nikon's Compacts give you the resolution to pick out horns from tree branches and glass big areas with ease.

WX		FINISH	EYE RELIEF (MM)	REAL ANGULAR FOV (DEGREES)	FOV @ 1000 YDS (FT)	CLOSE FOCUS (FT)	WEIGHT (OZ)	SIZE (LxW) (IN)	SRP
16033	7x50 IF	BLACK	17.7	10.7	563	40.4	85.4	10.7x6.7	\$5,999.95
16034	10x50 IF	BLACK	15.3	9.0	472	65.6	88.4	11.5x6.7	\$6,399.95
PROSTAFF									
7483	8x25	BLACK	15.5	6.3	330	9.2	12.5	3.9x4.5	\$129.95
7485	10x25	BLACK	15.9	5.0	262	9.2	12.9	4.0x4.5	\$139.95
TRAILBLAZER									
8217	8x25	BLACK	10.0	8.2	429	8.2	9.9	4.1x4.5	\$79.95
8218	10x25	BLACK	10.0	6.5	342	11.5	9.9	4.1x4.5	\$89.95
TRAVELITE									
7277	8x25	BLACK	14.0	5.6	293	9.8	9.3	4.5x4.6	\$99.95
7278	10x25	BLACK	11.1	5.0	262	9.8	9.5	4.3x4.6	\$109.95
7279	12x25	BLACK	11.1	4.2	220	13.1	9.7	4.3x4.6	\$119.95



FIELDSCOPES





FOCUS ON THE DETAILS

Whether you're spotting at extreme ranges or in low light, nothing matches the ability of Nikon's Fieldscopes to pull game out of the background and reveal every detail in optimum contrast, edge-to-edge resolution and brilliant color. At the top of the lineup is Nikon's MONARCH Fieldscope line, with a full complement of optical technologies and features. The Fieldscope 50mm ED is the lightweight workhorse of the bunch. The PROSTAFF 5 Fieldscopes are full-featured, yet compact and lightweight. The PROSTAFF 3 Outfit comes complete with compact tripod and carry case. You can't go wrong with any of them.



MONARCH



LONG EYE RELIEF
Provides 15mm or more of eye relief (12mm+ for compacts). A necessity for eyeglass wearers.

3x ZOOM RATIO
Offers flexibility for a variety of hunting situations and smooth zoom control.

FIELD FLATTENER LENS SYSTEM
Delivers sharp images all the way to the edge of the field of view.



FULLY MULTICOATED OPTICS
Multiple layers of anti-reflective coating on all air-to-glass surfaces maximize light transmission, brightness and contrast.

WATERPROOF
O-ring sealed to prevent moisture from entering body.

FOGPROOF
Nitrogen purged for total reliability against thermal shock.

ED GLASS
ED (Extra-low Dispersion) glass reduces chromatic aberration to a remarkable degree, providing clear images with superior contrast.

INTEGRAL SLIDING SUNSHADE
Keeps rain and glare off the objective lens.

A BETTER LOOK AT YOUR WORLD

True to its legendary name and reputation, the MONARCH Fieldscope pushes long-range viewing capability to an entirely new level for adventurous hunters and long-range shooters. Delivering a full complement of Nikon optical technologies engineered for an incredibly bright, clear, high resolution view across the entire viewing field, the flagship MONARCH Fieldscope makes long days of viewing both satisfying and strain-free.

With an innovative focusing system that reduces high-magnification scope movements and tough, light-weight aluminum alloy construction, the MONARCH Fieldscope assures its owner of a lifetime of high performance optical capability, mechanical precision and all-out ruggedness. Available in 60mm objective and 82mm objective models with straight or angled body.

FIELDSCOPE 50MM ED

SMALL, YET MIGHTY

The Fieldscope 50mm ED is incredibly compact and lightweight, perfect for tucking into your pack for all your hunting adventures. Nikon's ED glass delivers extremely bright, sharp true color images. Straight or angled body models.



COMPACT DESIGN
Weighs only one pound.

ED GLASS
ED (Extra-low Dispersion) glass reduces chromatic aberration to a remarkable degree, providing clear images with superior contrast.

FULLY MULTICOATED OPTICS
Multiple layers of anti-reflective coating on all air-to-glass surfaces maximize light transmission, brightness and contrast.

WATERPROOF
O-ring sealed to prevent moisture from entering body.

FOGPROOF
Nitrogen purged for total reliability against thermal shock.



MEP-30-60W



MEP-20-60



MEP-38W

MONARCH FIELDSCOPE MEP EYEPIECES

Nikon has developed eyepieces exclusively for MONARCH Fieldscopes. Each employs a new optical system, and a Field Flattener Lens System that delivers consistent sharpness and clarity across the entire field of view. While providing a wide field of view, MONARCH eyepieces also provide sufficiently long eye relief. When attached to a Fieldscope, each of the three new MEP eyepieces are waterproof*, ensuring safe use even during unexpected weather changes.

*Waterproof: As tested by water equivalent to 5mm per minute, for a duration of 30 minutes. (NOT designed for underwater usage)

MONARCH FIELDSCOPE

		FINISH	EYE RELIEF (MM)	REAL ANGULAR FOV (DEGREES)	FOV @ 1000 YDS (FT)	CLOSE FOCUS (FT)	WEIGHT (OZ)	LENGTH* (IN)	SRP
16102	16-48x60ED-S	BLACK	16.1-15.3	2.6-1.2	135-63	10.8	56.7	10.3/11.2	\$1,399.95
16103	16-48x60ED-A	BLACK	16.1-15.3	2.6-1.2	135-63	10.8	56.4	10.6/11.5	\$1,399.95
16100	20-60x82ED-S	BLACK	16.1-15.3	2.1-1.0	111-51	16.4	70.5	12.8/14.0	\$1,599.95
16101	20-60x82ED-A	BLACK	16.1-15.3	2.1-1.0	111-51	16.4	70.1	13.1/14.3	\$1,599.95

*With and without hood fully extended

MEP EYEPIECES

		W/FIELDSCOPE BODY	MAGNIFICATION	EYE RELIEF (MM)	REAL ANGULAR FOV (DEGREES)	FOV @ 1000 YDS (FT)	WEIGHT** (OZ)	SIZE (LxO.D.)** (IN)	SRP
16108	MEP-38W	60MM 82MM	30x 38x	18.5	2.5 2	132 105	9.5	2.9x2.4	\$299.95
16109	MEP-20-60*	60MM 82MM	16x-48x 20x-60x	16.1-15.3***	2.6-1.2*** 2.1-1.0***	135-63*** 111-51***	12.3	3.5x2.4	\$299.95
16110	MEP-30-60W	60MM 82MM	24x-48x 30x-60x	15.2-14.2***	2.5-1.5*** 2.0-1.2***	132-78*** 105-63***	14.1	3.6x2.4	\$549.95

*Included with MONARCH Fieldscopes ** (w/o caps) ***Designed reference value at highest magnification

FIELDSCOPE 50MM ED

		FINISH	EYE RELIEF (MM)	REAL ANGULAR FOV (DEGREES)	FOV @ 1000 YDS (FT)	CLOSE FOCUS (FT)	WEIGHT (OZ)	BODY SIZE (LxW)(IN)	SRP
8320	13-30x50ED-S	DK GREY	12.9@13x	3	157@13x	9.8	16.0	8.2x2.8	\$829.95
8321	13-30x50ED-A	DK GREY	12.9@13x	3	157@13x	9.8	16.6	8.1x2.8	\$829.95



PROSTAFF 5



WHERE POWER MEETS PRECISION

The PROSTAFF 5 Fieldscope offers a wide field of view and superb viewing in all conditions. It is engineered for precision and high magnification capability. Multilayer-coated lenses and prisms provide you with superb brightness. Super-fast bayonet eyepieces make scouting wide areas simple. Easy-to-pack and easy-to-use.

PROSTAFF 5 16-48x60MM

Compact, lightweight and tough, the PROSTAFF 5 Waterproof 60mm makes life easier on hunters going deep into the woods. Equipped with a sliding sunshade, the waterproof/fogproof scope is available in straight or angled body versions.



3x ZOOM RATIO
Offers flexibility for a variety of hunting situations.

FULLY MULTICOATED OPTICS

Multiple layers of anti-reflective coating on all air-to-glass surfaces maximize light transmission, brightness and contrast.

WATERPROOF

O-ring sealed to prevent moisture from entering body.

FOGPROOF

Nitrogen purged for total reliability against thermal shock.

PROSTAFF 5 20-60x82MM

The PROSTAFF 5 82mm spotting scope features a large objective lens for the brightest field of view, 20-60x zoom eyepiece, as well as straight or angled body versions and waterproof, fog-proof construction. PROSTAFF 5 Outfits include straight body, Vue-thru case, zoom eyepiece and full-size tripod.



PROSTAFF 3 16-48x60MM OUTFIT



FULLY MULTICOATED OPTICS

Multiple layers of anti-reflective coating on all air-to-glass surfaces maximize light transmission, brightness and contrast.

3x ZOOM RATIO

Offers flexibility for a variety of hunting situations.

WATERPROOF

O-ring sealed to prevent moisture from entering body.

FOGPROOF

Nitrogen purged for total reliability against thermal shock.

PROSTAFF 3

GRAB IT AND GO

The PROSTAFF 3 Fieldscope Outfit combines quality optics in a compact, rugged package for a take-anywhere spotter. The fully multicoated optics and 16-48x Zoom eyepiece guarantee you the best in versatility and performance. Packaged as an outfit, with compact tripod and carry case, the PROSTAFF 3 Fieldscope is ready for your next outing.

PROSTAFF 5

		FINISH	EYE RELIEF (MM)	REAL ANGULAR FOV (DEGREES)	FOV @ 1000 YDS (FT)	CLOSE FOCUS (FT)	WEIGHT (OZ)	LENGTH (IN)	SRP
6974	20-60x82ED-S	BLACK	16.9	2.1	109	20	41.4	14.8x3.7	\$599.95
6975	20-60x82ED-A	BLACK	16.9	2.1	109	20	41.8	15.4x3.7	\$599.95
6976	16-48x60ED-S	BLACK	16.9	2.6	136	13.1	34	11.4x3.3	\$499.95
6977	16-48x60ED-A	BLACK	16.9	2.6	136	13.1	34.4	12x3.3	\$499.95
6982	20-60x82ED-OUTFIT	BLACK	16.9	2.1	109	20	41.4	14.8x3.7	\$649.95

PROSTAFF 3

6983	16-48x60-S-OUTFIT	BLACK	19	2.3	120@16x	32.8	21.9	12.3x2.9	\$329.95
------	-------------------	-------	----	-----	---------	------	------	----------	----------



MOUNTING SOLUTIONS

MOUNTS FOR EVERY RIFLESCOPE.

Nikon's scope mounting systems are engineered to uphold the precision, strength and good looks designed into every Nikon riflescope. Choose from S-Series steel or A-Series aluminum rings and bases, mounts for the BLACK riflescope line, as well as for MSR platforms and rings for most firearms. All are CNC machined from solid bar stock and are held to incredibly tight tolerances and all are made in the USA.

BLACK 30MM



BLACK CANTILEVER MOUNTS

Nikon's new BLACK cantilever style mounting platform is designed for strength, precision and proper riflescope mounting position on MSR rifles. These precision-machined one-piece mounts offer perfect alignment and maximum surface contact area for your 30mm tube riflescope. Mil-Spec 1/2" hex nut clamp accepts 65 in/lb of torque.



BLACK PRECISION MOUNTS

Nikon's new BLACK Precision mount is a one-piece design engineered for exceptional precision, strength and perfect alignment of the integral 30mm rings. The unique design provides wider surface area contact with scope tube for maximum mounting security. Mil-Spec 1/2" hex nut accepts 65 in/lb of torque.

CANTILEVER MOUNTS

Built of strong-yet-lightweight alloy construction, Nikon's Cantilever mounts provide ideal height and fore-aft position for proper eye relief and charging handle access. M-TACTICAL for 30mm tubes, P-TACTICAL for one-inch tubes.



30MM



Also available in 20 MOA Cant One-Piece Mount



1-INCH



Also available in 20 MOA Cant One-Piece Mount

STEEL MOUNT RINGS AND BASES

The S-Series rings incorporate a square, stainless steel recoil control key in both the front and rear rings. This ensures a “no slip” positive recoil surface across the entire slot of the base that is capable of withstanding extreme recoil. These bases offer a full width recoil slot in each base that mates with the recoil control keys of S-Series rings, resulting in maximum bearing surface to fend-off severe recoil.

High Quality Steel Construction with Matte Black Finish—camo style rings also available.

Rings fit all S-Series/Weaver/Warner/Picatinny-style Bases.

Choose from models for 1-inch and 30mm tube riflescopes.



ALUMINUM MOUNT RINGS AND BASES

Engineered specifically for lighter-weight rifles, the lightweight and economical A-Series rings are designed for an incredible strength-to-weight ratio. These bases offer a full width recoil slot in each base that mates with the recoil bolt of A-Series rings, resulting in maximum bearing surface to manage recoil stress on the mount.

Strong, Lightweight Aluminum Alloy Construction with Matte Black Finish.

Rings fit all A-Series/Weaver/Warner/Picatinny-style Bases.

Choose from models for 1-inch and 30mm tube riflescopes.



S-SERIES RINGS & BASES

		SRP
16155	S-Series Low Rings Black Matte	\$49.95
16156	S-Series Med. Rings Black Matte	\$49.95
16157	S-Series High Rings Black Matte	\$49.95
740	S-Series High Rings Realtree MAX-1	\$79.95
741	S-Series Medium Rings Mossy Oak Brush	\$69.95
742	S-Series Medium Rings Mossy Oak Break Up	\$69.95
779	S-Series Medium Rings Realtree MAX-1	\$69.95
8182	S-Series Medium Rings Realtree APG	\$69.95
8183	S-Series Medium Rings (Quick Release) Realtree APG	\$99.95
16177	S-Series (30mm) Rings Medium Matte	\$54.95
16178	S-Series (30mm) Rings High Matte	\$54.95
16158	S-Series 700 Base Matte	\$29.95
16159	S-Series 10/110 Base Matte	\$29.95
16160	S-Series TC Base Matte	\$29.95
16161	S-Series 70 Base Matte	\$29.95
16162	S-Series 336 Base Matte	\$29.95
16163	S-Series A-Bolt Base Matte	\$29.95
16164	S-Series BAR Base Matte	\$29.95
16165	S-Series Mark V Base Matte	\$29.95

A-SERIES RINGS & BASES

16166	A-Series Low Rings Matte	\$21.95
16167	A-Series Medium Rings Matte	\$21.95
16220	A-Series Medium Rings Mossy Oak Brush	\$34.95
16221	A-Series Medium Rings Realtree MAX-1	\$34.95
16168	A-Series High Rings Matte	\$21.95
16179	A-Series (30mm) Rings Medium Matte	\$24.95
16180	A-Series (30mm) Rings High Matte	\$24.95
16181	A-Series Rimfire Rings Medium Matte	\$21.95
16169	A-Series 700 Base Matte	\$9.95
16170	A-Series 10/110 Base Matte	\$9.95
16171	A-Series TC Base Matte	\$9.95
16172	A-Series 70 Base Matte	\$9.95
16173	A-Series 336 Base Matte	\$9.95
16174	A-Series A-Bolt Base Matte	\$9.95
16175	A-Series BAR Base Matte	\$9.95
16176	A-Series Mark V Base Matte	\$9.95

BLACK SERIES 30mm MOUNTS

		SRP
16403	BLACK Cantilever MSR Height	\$139.95
16405	BLACK Cantilever (20 MOA Cant) MSR Height	\$139.95
16404	BLACK Precision MSR Height	\$139.95
16406	BLACK Precision Medium Height	\$139.95

M-TACTICAL 30mm CANTILEVER MOUNTS

839	M-TACTICAL 1-Piece	\$89.95
840	M-TACTICAL 1-Piece (20 MOA Cant)	\$99.95
16562	M-TACTICAL 2-Piece	\$59.95

P-TACTICAL 1-INCH CANTILEVER MOUNTS

16560	P-TACTICAL 1-Piece	\$79.95
16561	P-TACTICAL 1-Piece (20 MOA Cant)	\$89.95
835	P-TACTICAL 2-Piece	\$54.95
16349	P-TACTICAL 2-Piece - Flat Dark Earth	\$64.95



ACCESSORIES

TREX™

OPTIC CARRY SYSTEMS

Nikon's new TREX™ modular optic carry system adapts to your outdoor style and the conditions. The TREX harness comfortably distributes your optic's weight during long miles afield and is available in 3 variants—FreeStyle, EXO and 360—designed to address the degree of optics protection you seek. All models have a ventilated yoke that integrates a stowaway hydration net to accommodate your own hydration bladder.



TREX™

(FREESTYLE)

At the system's core is the TREX™ FreeStyle fully adjustable harness with quick-release attachment cords. This feature-packed harness securely holds your optic close to the chest while running or crawling, yet allows fast access for glassing. TREX™ FreeStyle comfortably distributes your optics weight during long miles afield.



(EXO)

The TREX™ EXO carry system integrates a lightweight exoskeleton shell that provides incredibly fast access. In conjunction with the harness's quick-release attachment cords that hold the optic securely in place, EXO offers protection of the eyepiece lenses even when the over-flap is not secured. Rear cellphone pocket has built-in microfiber cleaning cloth for keeping lenses smudge-free.



(360)

Nikon's TREX™ 360 full protection carry system is a great bet to keep your optic safe, clean and dry. The TREX™ 360 adds a water-resistant, padded optic compartment to shield and secure your glass while also keeping it at-the-ready. The patented closure system keeps the case closed tight to shield against water, snow and dirt. Interior and exterior pockets hold personal gear that requires quick access. Interior cellphone pocket has built-in microfiber cleaning cloth. MOLLE webbing system on front allows attachment of other gear, while a hand warmer pocket offers a compartment for a disposable pocket warmer.



Lightweight accessory tool for variable power scopes.

CNC machined from anodized 6061/T6 aluminum.

Enables quick and easy adjustment of the scope's power setting without moving from your shooting position.



Switchview™

Switchview™ enables quick and easy adjustment of a scope's power setting with a simple push or pull of the lever. Simply clamp it around the zoom ring of a variable power scope, and the extended arm gives the proper leverage to turn a stiff power selector ring, or to rapidly move from high to low power and vice versa.

SCOPECOAT™

Pull on cover protects your scope and exterior lenses from dirt, dust, snow and scratching. Water resistant, breathable, neoprene case draws moisture and condensation away from scope. SCOPECOAT™ stretches to custom fit your optic, from 1-1.5" over stated length.

TREX BINOCULAR CARRY SYSTEM

		SRP
16411	TREX™ FREESTYLE HARNESS	\$39.95
16415	TREX™ EXO CARRY SYSTEM	\$89.95
16414	TREX™ 360 CARRY SYSTEM	\$119.95
16413	TREX™ EXO BAG ONLY	\$49.95
16412	TREX™ 360 BAG ONLY	\$79.95

SWITCHVIEW

16407	SWITCHVIEW - MONARCH 3 / M-SERIES (1")	\$59.95
16408	SWITCHVIEW - MONARCH 5 (1") / MONARCH 7 / M-SERIES (30MM)	\$59.95
16409	SWITCHVIEW - PROSTAFF / PROSTAFF 5 / P-SERIES (1")	\$59.95

		SRP
16410	SWITCHVIEW - PROSTAFF 7 / P-308 (30MM)	\$59.95
16417	SWITCHVIEW - BUCKMASTERS (1")	\$59.95
16418	SWITCHVIEW - BLACK FX1000 / X1000 / FORCE1000 (30MM)	\$59.95
16567	SWITCHVIEW - M-TACTICAL (30MM) / P-TACTICAL (1")	\$59.95

SCOPECOAT

16399	SCOPECOAT 42MM (12.5" x 42MM - BLACK)	\$27.95
16400	SCOPECOAT 50MM (12.5" x 50MM - BLACK)	\$27.95
16401	SCOPECOAT 50MM (12.5" x 50MM - COYOTE BROWN)	\$27.95
16402	SCOPECOAT 52MM (14" x 52MM - BLACK)	\$29.95

Please visit NikonSportOptics.com for more information on the TREX™ Optic Carry System.



UNLOCK YOUR FIREARM'S ACCURACY POTENTIAL!

Match your riflescope and reticle to virtually any ammunition. All you need is a rifle, a Nikon riflescope and a rangefinder—Spot On does all the work for you—showing you all the shot possibilities before you pull the trigger! With an expansive database Spot On provides you with the precise aiming points at your specified range for any Nikon BDC reticle riflescope and instant reference for sighting in other Nikon riflescopes with Nikoplex, mildot or standard crosshair reticles.

YOU CAN FURTHER CUSTOMIZE YOUR SPOT ON RESULTS.

Customize Your Shooting Environment

Enter atmospheric conditions and other data that can affect your shot.



Spot On for Handloaders

Enter your custom load information and Spot On does the rest. You can even compare loads.



Expand Your BDC Reticle

See incredibly precise reticle aiming points, download and print. Tape it to your stock for easy reference.

Temp:39 - Altitude:3200 - BP:26.61 - Humidity:68

At 12.0X Magnification

WIND DRIFT (Inches): 15 mph from E

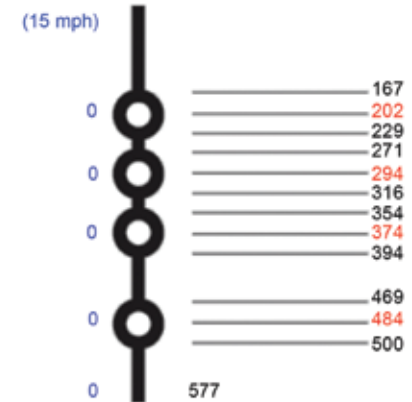

308 Winchester - 150gn Power Max Bonded - MV: 2820fps BC: 0.325

WE HOLD THE SPOT ON ADVANTAGE

The passion for precision has brought over a million shooters to Spot On. Its speed, simplicity and effectiveness is what keeps them coming back. Spot On precisely matches any cartridge and load to a Nikon riflescope and BDC reticle—providing the exact aiming points for every shooting distance imaginable. And with over a million possible accuracy combinations for virtually every centerfire, rimfire and muzzleloader load—even crossbow bolts—Spot On offers a real advantage for long-range precision.

MATCH YOUR NIKON RIFLESCOPE TO VIRTUALLY ANY AMMUNITION!

SIMPLE TO USE:

- 1 Choose your rifle scope and reticle
- 2 Choose your ammunition
- 3 Enter your sight-in and target distances and fire

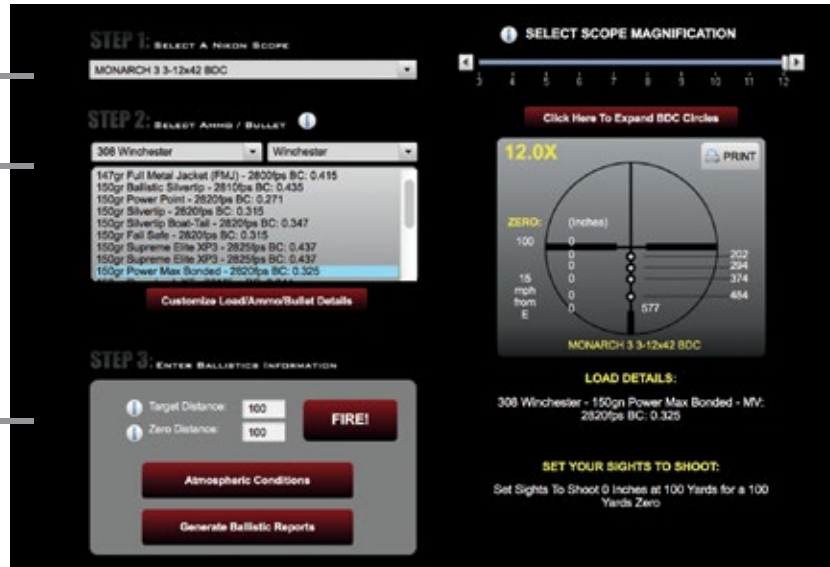

Generate Ballistic Data Reports

You can create Field Reference Charts, Ballistic Tables and Ballistic Trajectory Graphs of your particular load.

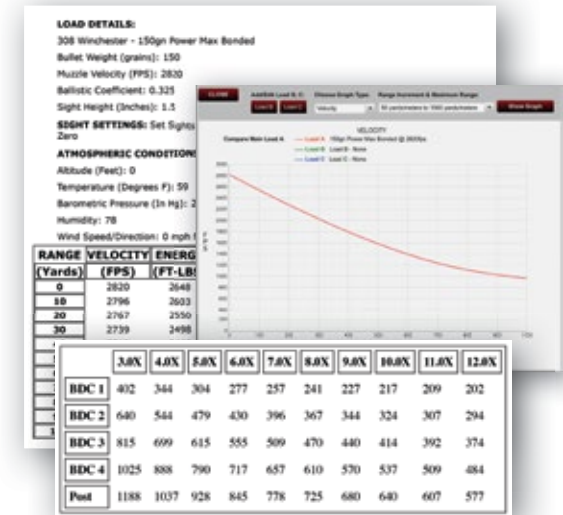

SPOT ON CUSTOM TURRETS

The Spot On Custom Turret Program is a practical way for shooters to compensate for bullet drop and make accurate long-range shots. Each Spot On Custom Turret is personalized for an individual shooter based on ballistic information he or she enters on the online ordering page. Select your ammunition, rifle scope, typical atmospheric conditions and much more to create your own uniquely calibrated turret.

GIVE IT A SHOT!

NikonSportOptics.com/SpotOn

Free Mobile App

Spot On is now available at no cost for the iPhone®, iPad® and Android™ platforms. Get the app and ensure that the world's hottest ballistics calculator is there when you need it.

Spot On Wind Meter

Nikon's Spot On Ballistic Wind Meter gets you the readings you need to get the most out of your Advanced BDC reticle.



SPOT ON WIND METER

16144

SRP

\$39.95



RIFLESCOPE RETICLE SUBTENSIONS

BLACK RETICLE SUBTENSIONS (MOA/MRAD AT 100 YARDS)									
	BLACK FX1000				BLACK X1000				BLACK FORCE1000
	4-16x50SF		4-16x50SF		4-16x50SF		6-24x50SF		1-4x24
	FX-MOA/IL FX-MOA	FX-MRAD/IL FX-MRAD	FX-MOA/IL FX-MOA	FX-MRAD/IL FX-MRAD	X-MOA/IL X-MOA	IL X-MRAD	IL X-MOA	IL X-MRAD	IL SPEEDFORCE
	4x-16x MOA	4x-16x MRAD	6x-24x MOA	6x-24x MRAD	16x MOA	16x MRAD	18x MOA	18x MRAD	4x MOA
A	0.14	0.038	0.14	0.038	0.15	0.5	0.15	0.5	2.0
B	0.75	0.1	0.75	0.1	2	1	2	1	17.0
C	1	0.2	1.0	0.2	10	2	10	2	25.0
D	1.5	0.3	1.5	0.3	20	5	20	5	1.0
E	2.5	0.6	2.5	0.60	1	0.25	1	0.25	1.5
F	2.75	0.7	2.75	0.7	4		4		0.5
G	5	1	5.0	1.0	6		6		4.0
H	10	2	10.0	2.0					2.5
I	20	8	20.0	8.0					10.0
J	30		30.0						17.5
K									20.0
L									35.0
M									3.2
N									6.3
O									6.5
P									8.5
Q									5.0
R									3.0

M-TACTICAL RETICLE SUBTENSIONS (AT 100 YARDS)						
	M-TACTICAL			M-TACTICAL .308	M-TACTICAL .223	
	1-4x24		3-12x42SF		4-16x42SF	4-16x42SF
	MK1-MOA	MK1-MOA	MK1-MRAD	BDC 800	BDC 600	
	4x MOA	16x MOA	16x MRAD	16x inches	16x inches	
A	0.35	0.15	0.05	0.2	0.25	
B	1.5	1.0	0.25	7	8	
C	1.75	1.75	0.5	0.6	0.5	
D	2.0	2.0	1.0	1	1	
E	4.0	4.0	1.5	0.75	0.75	
F	5.0	5.0	6.0	2	1.5	
G	10.0	10.0	10.0	3.5	2.5	
H	20.0	20.0		5	3.75	
I	30.0	30.0		6.5	5	
J				8.25	6.5	
K				10.25	8.25	
L				12.5	10.25	
M				14.5	12.5	
N				16.75	14.75	
O				19	17	
P				21.75	1	
Q				24.5		
R				27.25		
S				30.5		
T				33.8		
U				1		
V				0.5		
W				0.2		
X				0.6		

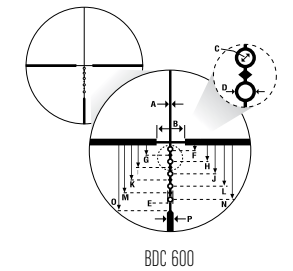
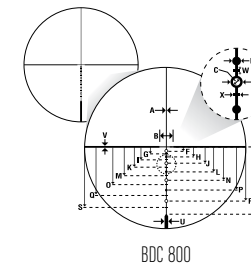
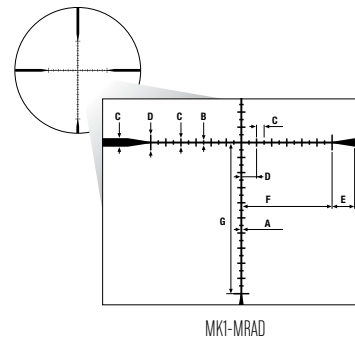
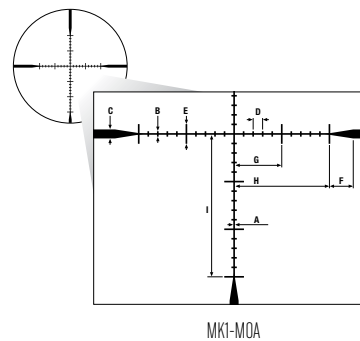
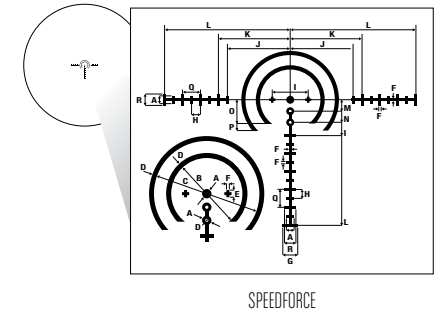
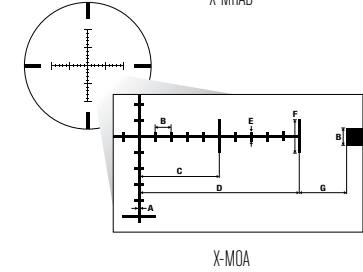
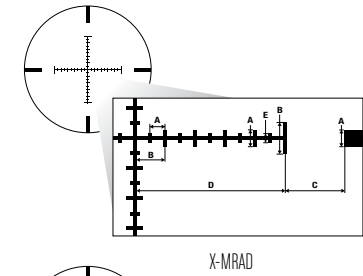
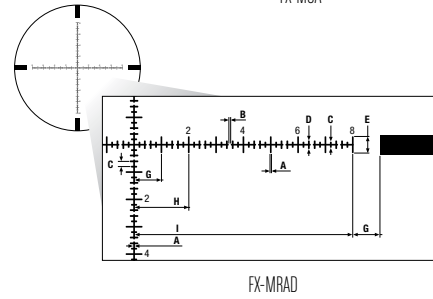
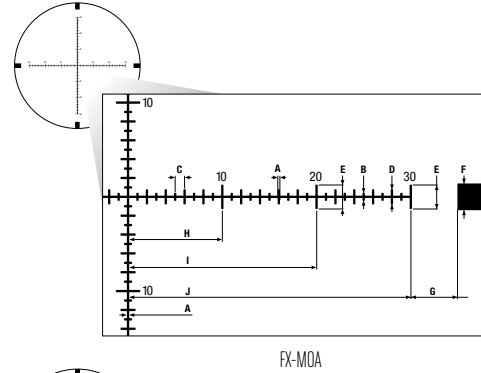

RIFLESCOPE RETICLE SUBTENSIONS

P-TACTICAL RETICLE SUBTENSIONS (AT 100 YARDS)										
	P-TACTICAL		P-TACTICAL .308	P-TACTICAL 300BLK	P-TACTICAL .223				P-TACTICAL RIMFIRE	
	3-9x40		4-12x40	2-7x32	1.5-4.5x20	3x32	3-9x40	4-12x40	2-7x32	
	MK1-MOA	MK1-MRAD	BDC 800	BDC SuperSub	BDC 600	BDC Carbine	BDC 600	BDC 600	MK1-MOA	BDC 150
	9x	12x	7x	4.5x	3x	9x	12x	7x	7x	7x
	MOA	MRAD	inches	inches	inches	inches	inches	inches	MOA	inches
A	0.15	0.05	0.2	0.5	0.5	1.0	0.25	0.25	0.2	0.3
B	1.0	0.25	7.0	30.0	8.0	24.0	8.0	8.0	1.0	8.0
C	1.75	0.5	0.6	3.0	1.0	1.0	0.5	0.5	1.75	1.0
D	2.0	1.0	1.0	2.0	2.0	3.4	1.0	1.0	2.0	2.0
E	4.0	1.5	0.75	2.5	1.0	5.5	0.75	0.75	4.0	4.5
F	5.0	6.0	2.0	5.0	1.5	14.3	1.5	1.5	5.0	7.0
G	10.0	10.0	3.5	8.0	3.75	20.0	2.5	2.5	10.0	11.0
H	20.0		5.0	11.5	5.0	3.0	3.75	3.75	20.0	15.0
I	30.0			6.5	15.0	6.5		5.0	30.0	2.0
J			8.25	19.5	8.25		6.5	6.5		1.4
K			10.25	24.0	10.25		8.25	8.25		
L			12.50	29.0	12.5		10.25	10.25		
M			14.50	35.0	14.75		12.5	12.5		
N			16.75	2.0	17		14.75	14.75		
O			19.0	6.0	1		17.0	17.0		
P			21.75	9.0			1.0	1.0		
Q			24.5	12.0						
R			27.25	0.5						
S			30.5	1.5						
T			33.8							
U			1.0							
V			0.5							
W			0.2							
X			0.6							

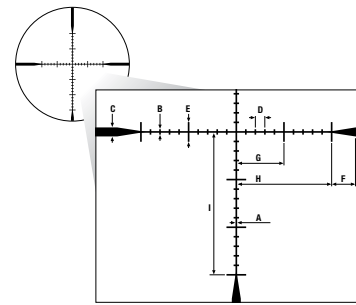

MK1-MOA

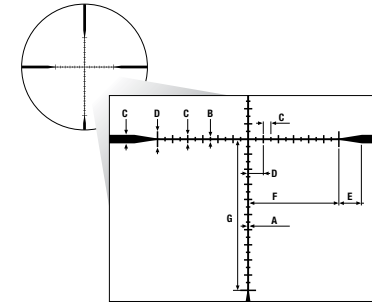

MK1-MRAD

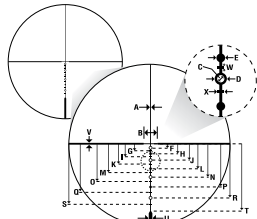

BDC 800

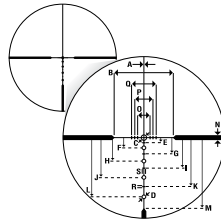

BDC SuperSub

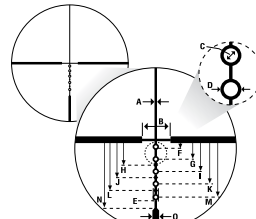

BDC 600-1.5-4.5x20

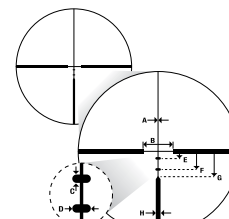

BDC Carbine

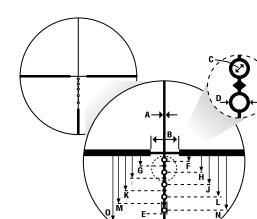

BDC 600

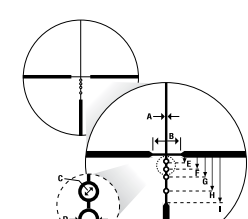

BDC 150

MONARCH 7 30MM RETICLE SUBTENSIONS (INCHES AT 100 YARDS)										
	2.5-10x50SF		3-12x56SF		3-12x56SF IR		4-16x50SF		4-16x50SF IR	
	Advanced BDC		Advanced BDC		Advanced BDC with Dot		Advanced BDC		Advanced BDC with Dot	
	2.5x	10x	3x	12x	3x	12x	4x	16x	4x	16x
A	1.00	0.25	1.00	0.25	1.00	0.25	1.00	0.25	1.00	0.25
B	32.00	8	32.00	8.00	32.00	8.00	32.00	8.00	32.00	8.00
C	2.00	0.50	2.00	0.50	2.00	0.50	2.00	0.50	2.00	0.50
D	4.00	1.00	4.00	1.00	4.00	1.00	4.00	1.00	4.00	1.00
E	8.00	2.00	8.00	2.00	8.00	2.00	8.00	2.00	8.00	2.00
F	18.00	4.50	18.00	4.50	18.00	4.50	18.00	4.50	18.00	4.50
G	28.00	7.00	28.00	7.00	28.00	7.00	28.00	7.00	28.00	7.00
H	44.00	11.00	44.00	11.00	44.00	11.00	44.00	11.00	44.00	11.00
I	60.00	15.00	60.00	15.00	60.00	15.00	60.00	15.00	60.00	15.00
J	4.00	1.00	4.00	1.00	4.00	1.00	4.00	1.00	4.00	1.00
K	8.00	2.00	8.00	2.00	8.00	2.00	8.00	2.00	8.00	2.00
L	9.00	2.25	9.00	2.25	9.00	2.25	9.00	2.25	9.00	2.25
M	14.00	3.50	14.00	3.50	14.00	3.50	14.00	3.50	14.00	3.50
N	20.00	5.00	20.00	5.00	20.00	5.00	20.00	5.00	20.00	5.00
O	1.00	0.25	1.00	0.25	1.00	0.25	1.00	0.25	1.00	0.25
P	4.00	1.00	4.00	1.00	4.00	1.00	4.00	1.00	4.00	1.00
Q					2.52	0.63			1.88	0.47

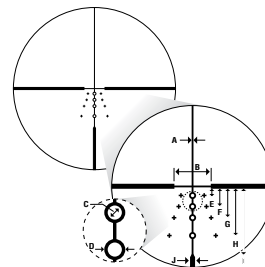

Advanced BDC

MONARCH 5 RETICLE SUBTENSIONS (INCHES AT 100 YARDS)				
	4-20x50ED SF		6-30x50ED SF	
	Advanced BDC		Advanced BDC	
	4x	20x	6x	30x
A	0.50	0.1	0.50	0.1
B	40.00	8	40.00	8
C	4.00	0.8	4.00	0.8
D	5.00	1	5.00	1
E	10.00	2	10.00	2
F	22.50	4.5	22.50	4.5
G	35.00	7	35.00	7
H	55.00	11	55.00	11
I	75.00	15	75.00	15
J	2.50	0.5	2.50	0.5
K	10.00	2	10.00	2
L	11.25	2.25	11.25	2.25
M	17.50	3.5	17.50	3.5
N	25.00	5	25.00	5
O	0.50	0.1	0.50	0.1
P	5.00	1	5.00	1

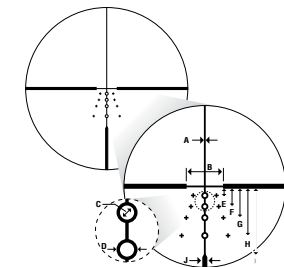

Advanced BDC



RIFLESCOPE RETICLE SUBTENSIONS

MONARCH 3 RETICLE SUBTENSIONS (INCHES AT 100 YARDS)																						
	1-4x20		3-12x42SF		3-12x42SF		4-16x42SF		4-16x42SF		4-16x42SF		4-16x50SF		4-16x50SF		4-16x50SF		5-20x44SF		6-24x50SF	
	German #4		BDC	BDC	BDC FFP	Nikoplex/XR Turret		BDC	BDC FFP	Mildot	Nikoplex/XR Turret		BDC	BDC FFP	BDC	BDC	BDC	BDC	BDC	BDC	BDC	BDC
	1x	4x	12x	3x-12x	4x	16x	16x	4x-16x	12 (MIL)	4x	16x	16x	4x-16x	20x	24x							
A	26.55	6.64	0.25	0.25	1.88	0.47	0.25	0.25	2	1.88	0.47	0.25	0.25	0.25	0.25							
B	2.63	0.66	5.75	6.00	0.49	0.12	4.31	4	0.25	0.49	0.12	4	4	3.45	2.88							
C	133.28	33.32	1.5	1.5	17.25	4.31	1.5	1.5	36	17.3	4.33	1.5	1.5	1.5	1.5							
D			2	2			2	2	0.72			2	2	2	2							
E			2	2			2	2	3.6			2	2	2	2							
F			4.5	4.5			4.5	4.5				4.5	4.5	4.5	4.5							
G			7	7			7	7				7	7	7	7							
H			11	11			11	11				11	11	11	11							
I			15	15			15	15				15	15	15	15							
J			1	1			1	1				1	1	1	1							

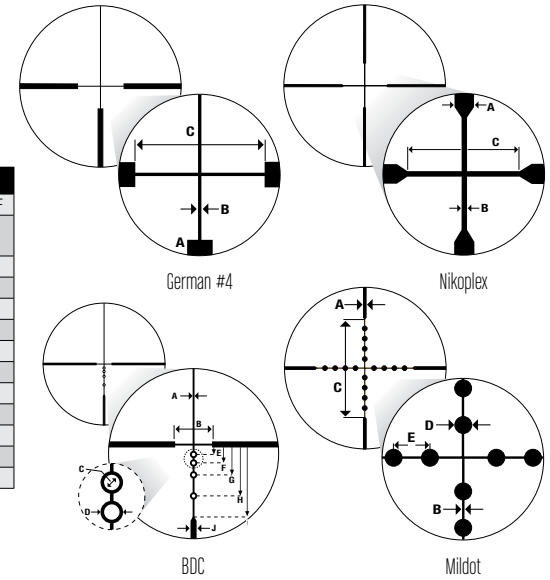

PROSTAFF 7 RETICLE SUBTENSIONS (INCHES AT 100 YARDS)																
	2.5-10x42		2.5-10x50		2.5-10x50		3-12x42SF		4-16x42SF		4-16x50SF		4-16x50SF		5-20x50SF	
	BDC		Nikoplex		BDC		BDC		BDC		Nikoplex		BDC		BDC	
	2.5x	10x	2.5x	10x	2.5x	10x	3x	12x	4x	16x	4x	16x	4x	16x	5x	20x
A	1	0.25	3.04	0.76	1	0.25	1	0.25	1	0.25	1.88	0.47	1	0.25	1	0.25
B	28	7	0.8	0.2	28	7	24	6	16	4	0.48	0.12	16	4	16	4
C	6	1.5	27.76	6.94	6	1.5	6	1.5	6	1.5	17.24	4.31	6	1.5	6	1.5
D	8	2			8	2	8	2	8	2			8	2	8	2
E	8	2			8	2	8	2	8	2			8	2	8	2
F	18	4.5			18	4.5	18	4.5	18	4.5			18	4.5	18	4.5
G	28	7			28	7	28	7	28	7			28	7	28	7
H	44	11			44	11	44	11	44	11			44	11	44	11
I	60	15			60	15	60	15	60	15			60	15	60	15
J	4	1			4	1	4	1	4	1			4	1	4	1

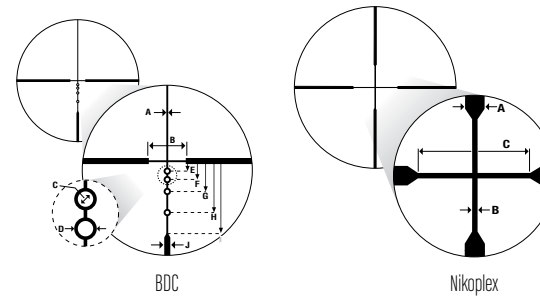

PROSTAFF 5 RETICLE SUBTENSIONS (INCHES AT 100 YARDS)																										
	2.5-10x40		2.5-10x40		2.5-10x50		3.5-14x40SF		3.5-14x40SF		3.5-14x40SF		3.5-14x50SF		3.5-14x50SF		4.5-18x40SF		4.5-18x40SF		4.5-18x40SF		4.5-18x40SF			
	Nikoplex		BDC		BDC		Nikoplex		BDC		BDC FFP		Mildot		BDC		BDC FFP		Nikoplex		BDC		BDC FFP		Mildot	
	2.5x	10x	10x	10x	3.5x	14x	14x	3.5x-14x	14 (MIL)	14x	3.5x-14x	14x	3.5x-14x	4.5x	18x	18x	4.5x-18x	14 (MIL)								
A	3	0.75	0.25	0.25	2.16	0.54	0.25	0.75	2	0.25	0.75	1.68	0.42	0.25	0.5	2										
B	0.76	0.19	10	10	0.56	0.14	10	5	0.25	10	5	0.44	0.11	10	3.5	0.25										
C	27.6	6.9	1.5	1.5	19.6	4.9	1.5	1.5	36	1.5	1.5	15.2	3.8	1.5	1.5	36										
D			2	2			2	3	0.72	2	3			2	2.5	0.72										
E			2	2			2	2	3.6	2	2			2	3.6											
F			4.5	4.5			4.5	4.5		4.5	4.5			4.5	4.5											
G			7	7			7	7		7	7			7	7											
H			11	11			11	11		11	11			11	11											
I			15	15			15	15		15	15			15	15											
J			1	1			1	1		1	1			1	1											

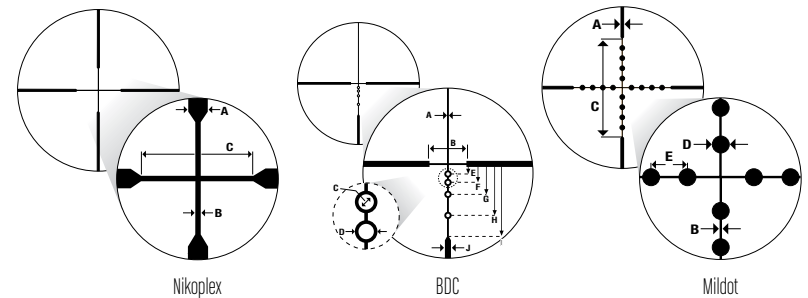

RIFLESCOPE RETICLE SUBTENSIONS

PROSTAFF and BUCKMASTERS II RETICLE SUBTENSIONS (INCHES)															
	PROSTAFF									BUCKMASTERS II					
	2-7x32		3-9x40		3-9x40		3-9x50		4-12x40		4-12x40		4-12x40		
	Nikoplex (@75 yds)		Nikoplex (@100yds)		BDC (@100yds)		Nikoplex (@100yds)		BDC (@100yds)		Mildot (@100yds)		BDC		
	2x	7x	3x	9x	9x	3x	9x	9x	4x	12x	12x	12 (MIL)	9x	12x	9x
A	2.91	0.83	2.58	0.86	0.25	2.58	0.9	0.25	1.94	0.65	0.25	2	0.25	0.25	0.25
B	0.76	0.22	0.67	0.22	8	0.67	0.22	8	0.5	0.17	8	0.25	8	6	8
C	26.74	7.64	23.77	7.92	1.5	23.8	7.9	1.5	17.83	5.94	1.5	36	1.5	1.5	1.5
D					2			2			2	0.72	2	2	2
E					2			2			2	3.6	2	2	2
F					4.5			4.5			4.5		4.5	4.5	4.5
G					7			7			7		7	7	7
H					11			11			11		11	11	11
I					15			15			15		15	15	15
J					1			1			1		1	1	1

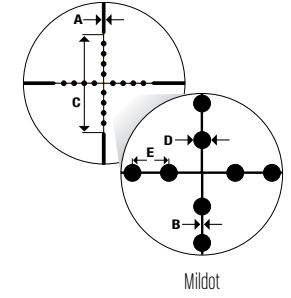
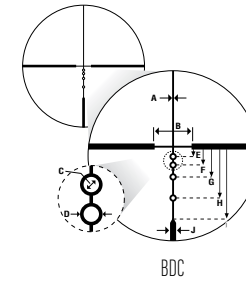
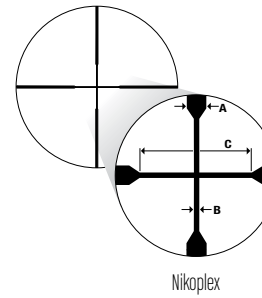

SPECIALTY RIFLESCOPES RETICLE SUBTENSIONS (INCHES)												
	PROSTAFF P3 PREDATOR HUNTER		PROSTAFF P3 MUZZLELOADER	PROSTAFF P3 SHOTGUN		PROSTAFF RIMFIRE II		PROSTAFF P3 TARGET EFR		FORCE XR		PROSTAFF P3 CROSSBOW
	3-9x40	4-12x40	3-9x40	2-7x32	3-9x40	3-9x40	4-12x40	3-9x40 AO	2x20	2.5-8x28	3x32	
	BDC Predator (@100yds)	BDC Predator (@100yds)	BDC 300 (@100yds)	BDC 200 (@100yds)	BDC 200 (@100yds)	BDC 150 (@50yds)	BDC 150 (@50yds)	PRECISION (@50yds)	Nikoplex (@100yds)	BDC Handgun (@100yds)	BDC 60 (@100 yds)	
	9x	12x	9x	7x	9x	9x	12x	3x	9x	2x	8x	3x
A	0.25	0.25	0.25	0.5	0.25	0.25	0.25	0.75	0.25	2.38	0.25	0.25
B	8	8	8	8	8	8	8	90	30	0.8	10	6
C	3	3	1.5	1.5	1.5	1.5	1.5	2.25	0.75	40.95	1.5	0.75
D	2	2	2	2.5	2	2	2	45	15		2	1.25
E	1	1	2	2.5	2.5	2	2	3	1		2.5	0.5
F	4	4	4	5.3	5.25	4.5	4.5				6	1
G	3	3	8	8	8	7	7				15	3
H	5.5	5.5	13	12	12	11	11				1	2.75
I	8	8	18	18	18	15	15					6.5
J	1	1	2	2	2	1	1					11
K												14
L												20
M												1

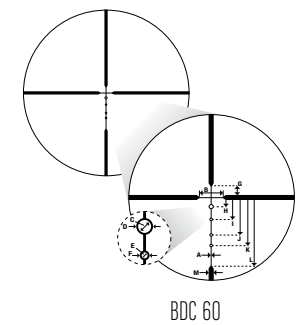
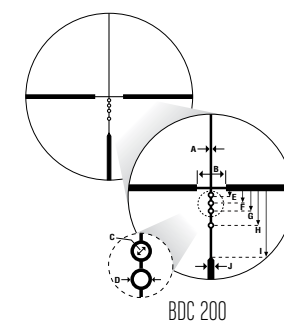
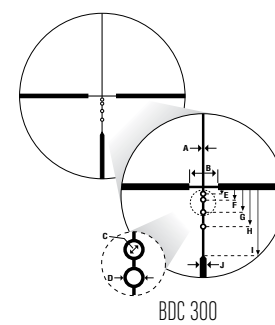
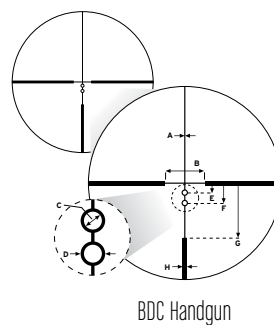
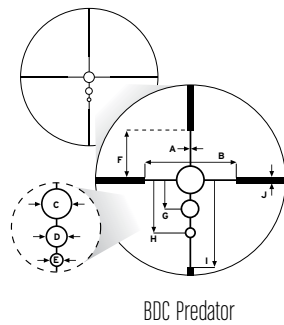
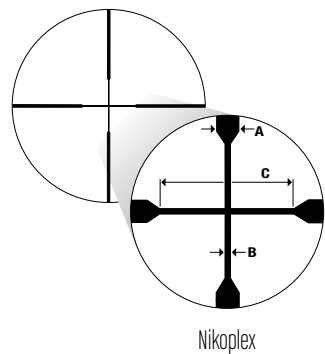
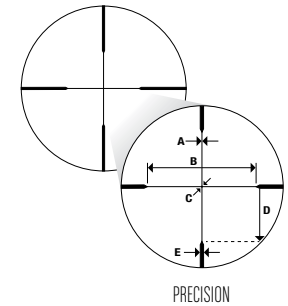
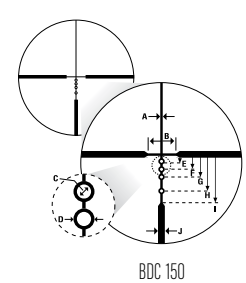
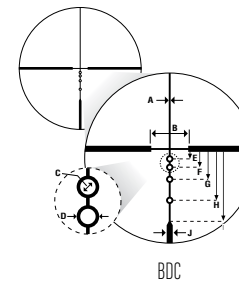



ARD (Anti-Reflective Device) is manufactured by Tenebraex. Realtree APG, Realtree XTRA Green, REALTREE Max-1, REALTREE Hardwoods Green HD and all respective logos are registered trademarks of Jordan Outdoor Enterprises, LTD. Mossy Oak Brush and Mossy Oak Break Up and all respective logos are registered trademarks of Robinson Outdoor Products, LLC. iPhone and iPad are registered trademarks of Apple Inc. Android is a trademark of Google Inc. Scopecoat is a trademark of SENTRY Products Group, LLC. Switchview is a trademark of Mike Gibson Manufacturing.

All Nikon Trademarks are the property of Nikon Corporation.

CONTACT

Technical Information 1-800-NIKON US

Service & Repair 1-800-NIKON SV

Nikon Service & Repair Center

6420 Wilshire Blvd., Suite 100, Los Angeles, CA 90048-5501

Features and specifications subject to change without notice.

NikonSportOptics.com

© Copyright 2018 Nikon Corporation

SRO358